

AN11368

BGU8019 GNSS LNA evaluation board

Rev. 2 — 21 February 2014

Application note

Document information

Info	Content
Keywords	BGU8019, GNSS, LNA
Abstract	This document explains the BGU8019 GNSS LNA evaluation board
Ordering info	<u>Board-number:</u> OM7848 <u>12NC:</u> 9340 682 12598
Contact information	For more information, please visit: http://www.nxp.com



Revision history

Rev	Date	Description
2	20140221	Updated figures + test results.
1	20130910	First publication

Contact information

For more information, please visit: <http://www.nxp.com>

For sales office addresses, please send an email to: salesaddresses@nxp.com

1. Introduction

NXP Semiconductors' BGU8019 Global Navigation Satellite System (GNSS) LNA Evaluation Board is designed to evaluate the performance of the GNSS LNA using:

- NXP Semiconductors' BGU8019 GNSS Low Noise Amplifier
- A matching inductor
- A decoupling capacitor

NXP Semiconductors' BGU8019 is a low-noise amplifier for GNSS receiver applications in a plastic, leadless 6 pin, extremely thin small outline SOT1232 at 1.1 x 0.7 x 0.37mm, 0.4mm pitch. The BGU8019 features gain of 18.5 dB and a noise figure of 0.55 dB at a current consumption of 4.6 mA. Its superior linearity performance removes interference and noise from co-habitation cellular transmitters, while retaining sensitivity. The LNA components occupy a total area of approximately 4 mm².

In this document, the application diagram, board layout, bill of materials, and typical results are given, as well as some explanations on GNSS related performance parameters like out-of-band input third-order intercept point O_{IIP3}, gain compression under jamming and noise under jamming.

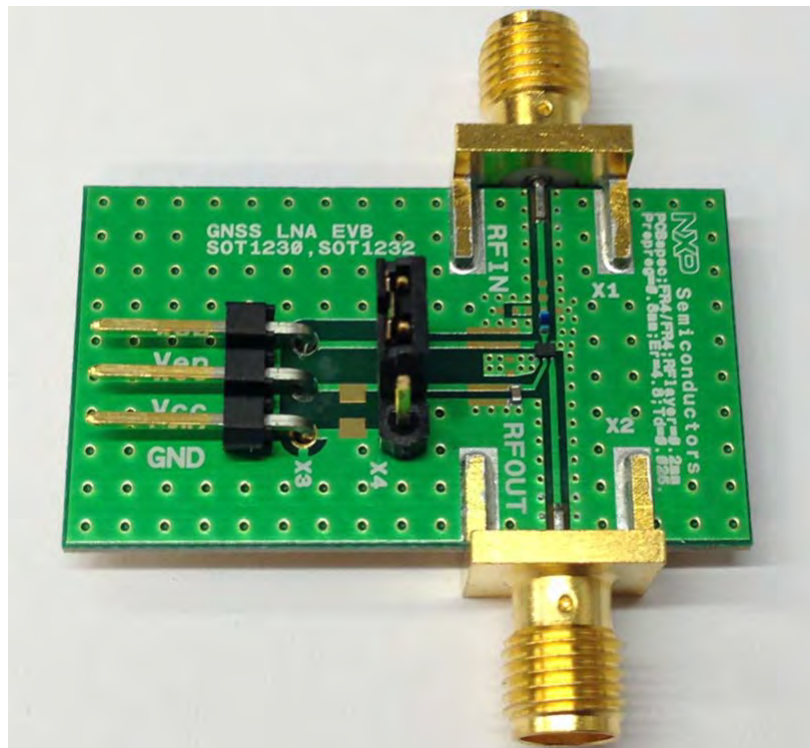

Fig 1. BGU8019 GNSS LNA evaluation board

2. General description

Modern cellular phones have multiple radio systems, so problems like co-habitation are quite common. A GNSS receiver implemented in a mobile phone requires the following factors to be taken into account.

All the different transmit signals that are active in smart phones and tablets can cause problems like inter-modulation and compression.

Since the GNSS receiver needs to receive signals with an average power level of -130 dBm, sensitivity is very important. Currently there are several GNSS chipsets on the market that can be implemented in cell phones, tablets etc. Although many of these GNSS ICs do have integrated LNA front ends, the noise performance, and as a result the system sensitivity, is not always adequate. The GNSS receiver sensitivity is a measure how accurate the coordinates are calculated. The GNSS signal reception can be improved by a so called GNSS LNA, which improves the sensitivity by amplifying the wanted GNSS signal with a low-noise amplifier.

3. BGU8019 GNSS LNA evaluation board

The BGU8019LNA evaluation board simplifies the RF evaluation of the BGU8019 GNSS LNA applied in a GNSS front-end, often used in mobile cell phones. The evaluation board enables testing of the device RF performance and requires no additional support circuitry. The board is fully assembled with the BGU8019 including the input series inductor and decoupling capacitor. The board is supplied with two SMA connectors for input and output connection to RF test equipment. The BGU8019 can operate from a 1.5 V to 3.1 V single supply and consumes typical 4.6 mA.

3.1 Application Circuit

The circuit diagram of the evaluation board is shown in Fig 2. With jumper JU1 the enable input can be connected either to Vcc or GND.

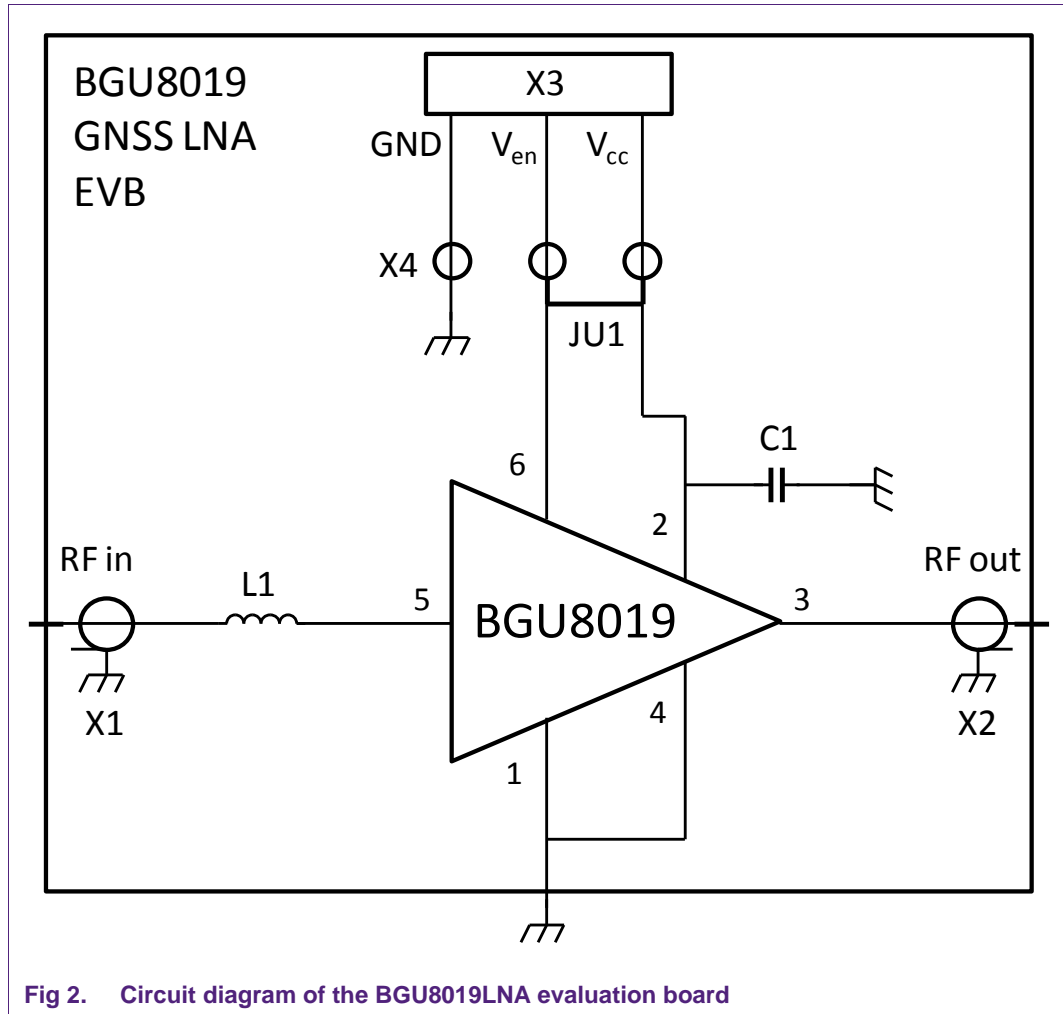

Fig 2. Circuit diagram of the BGU8019LNA evaluation board

3.2 PCB Layout

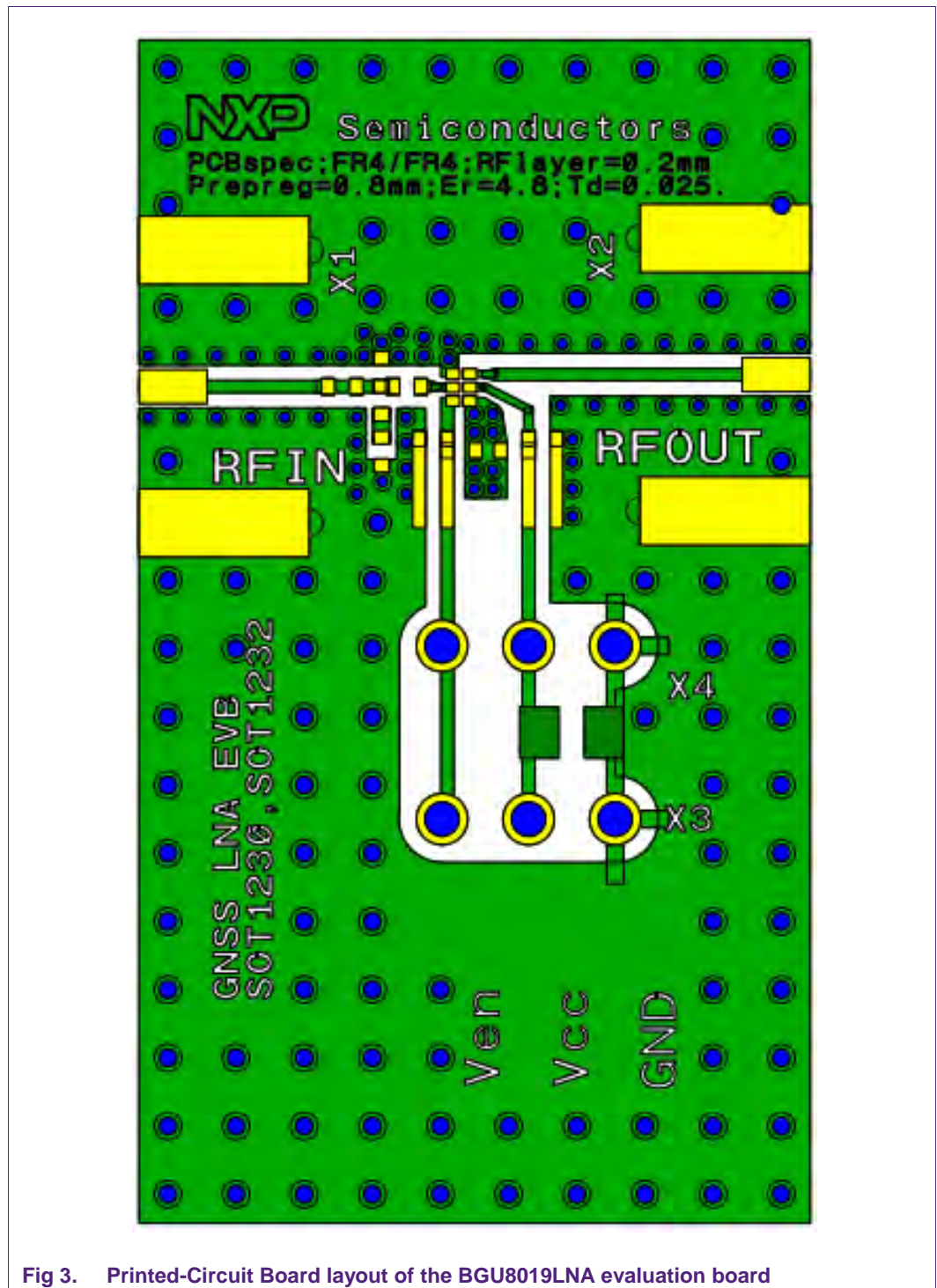
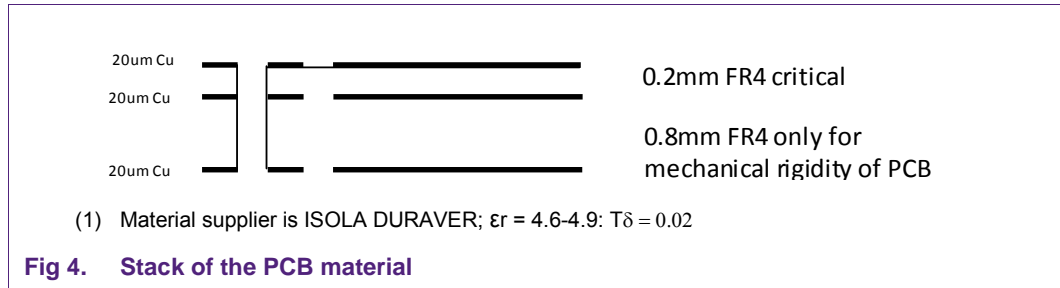

Fig 3. Printed-Circuit Board layout of the BGU8019LNA evaluation board

A good PCB layout is an essential part of an RF circuit design. The LNA evaluation board of the BGU8019 can serve as a guideline for laying out a board using the BGU8019. Use controlled impedance lines for all high frequency inputs and outputs. Bypass Vcc with

decoupling capacitors, preferably located as close as possible to the device. For long bias lines it may be necessary to add decoupling capacitors along the line further away from the device. Proper grounding of the GND pins is also essential for good RF performance. Either connect the GND pins directly to the ground plane or through vias, or do both, which is recommended. The material that has been used for the evaluation board is FR4 using the stack shown in Fig 4.



4. Bill of materials

Table 1. BOM of the BGU8019 GNSS LNA evaluation board

Designator	Description	Footprint	Value	Supplier Name/type	Comment
A	BGU8019	1.1 x 0.7 x 0.37mm ³ , 0.4mm pitch		NXP	SOT1232
PCB		20 x 35mm		BGU8019 GNSS LNA EV Kit	
C1	Capacitor	0402	1nF	Murata GRM1555	Decoupling
L1	Inductor	0402	6.8nH	Murata LQW15	Input matching
X1, X2	SMA RD connector	-	-	Johnson, End launch SMA 142-0701-841	RF input/ RF output
X3	DC header	-	-	Molex, PCB header, Right Angle, 1 row, 3 way 90121-0763	Bias connector
X4	JUMPER Stage	-	-	Molex, PCB header, Vertical, 1 row, 3 way 90120-0763	Connect Ven to Vcc or separate Ven voltage
JU1	JUMPER				

4.1 BGU8019

NXP Semiconductors' BGU8019 GNSS low noise amplifier is designed for the GNSS frequency band. The integrated biasing circuit is temperature stabilized, which keeps the current constant over temperature. It also enables the superior linearity performance of the BGU8019. The BGU8019 is also equipped with an enable function that allows it to be controlled via a logic signal. In disabled mode it consumes less than 1 μ A.

The output of the BGU8019 is internally matched for 1575.42 MHz whereas only one series inductor at the input is needed to achieve the best RF performance. Both the input and output are AC coupled via an integrated capacitor.

It requires only two external components to build a GNSS LNA having the following advantages:

- Low noise
- System optimized gain
- High linearity under jamming
- 1.1 x 0.7 x 0.37, 0.4mm pitch: SOT1232
- Low current consumption
- Short power settling time

4.2 Series inductor

The evaluation board is supplied with Murata LQW15 series inductor of 6.8 nH. This is a wire wound type of inductor with high quality factor (Q) and low series resistance (Rs). This type of inductor is recommended in order to achieve the best noise performance. High Q inductors from other suppliers can be used. If it is decided to use other low cost inductors with lower Q and higher Rs the noise performance will degrade.

5. Required Equipment

In order to measure the evaluation board the following is necessary:

- ✓ DC Power Supply op to 30 mA at 1.5 V to 3.1 V
- ✓ Two RF signal generators capable of generating RF signals at the operating frequency of 1575.42 MHz, as well as the jammer frequencies 1713.42 MHz and 1851.42 MHz
- ✓ An RF spectrum analyzer that covers at least the operating frequency of 1575.42 MHz as well as a few of the harmonics. Up to 6 GHz should be sufficient.
“Optional” a version with the capability of measuring noise figure is convenient
- ✓ Amp meter to measure the supply current (optional)
- ✓ A network analyzer for measuring gain, return loss and reverse isolation
- ✓ Noise figure analyzer and noise source
- ✓ Directional coupler
- ✓ Proper RF cables

6. Connections and setup

The BGU8019 GNSS LNA evaluation board is fully assembled and tested. Please follow the steps below for a step-by-step guide to operate the LNA evaluation board and testing the device functions.

1. Connect the DC power supply to the V_{cc} and GND terminals. Set the power supply to the desired supply voltage, between 1.5 V and 3.1 V, but never exceed 3.1 V as it might damage the BGU8019.
2. Jumper JU1 is connected between the V_{cc} terminal of the evaluation board and the V_{en} pin of the BGU8019.
3. Connect the RF signal generator and the spectrum analyzer to the RF input and the RF output of the evaluation board, respectively. Do not turn on the RF output of the signal generator yet, set it to -45 dBm output power at 1575.42 MHz, set the spectrum analyzer at 1575.42 MHz center frequency and a reference level of 0 dBm.
4. Turn on the DC power supply and it should read approximately 4.6 mA.
5. Enable the RF output of the generator: The spectrum analyzer displays a tone around -26.5 dBm at 1575.42 MHz.
6. Instead of using a signal generator and spectrum analyzer one can also use a network analyzer in order to measure gain as well as in- and output return loss.
7. For noise figure evaluation, either a noise figure analyzer or a spectrum analyzer with noise option can be used. The use of a 5 dB noise source, like the Agilent 364B is recommended. When measuring the noise figure of the evaluation board, any kind of adaptors, cables etc between the noise source and the evaluation board should be minimized, since this affects the noise figure.

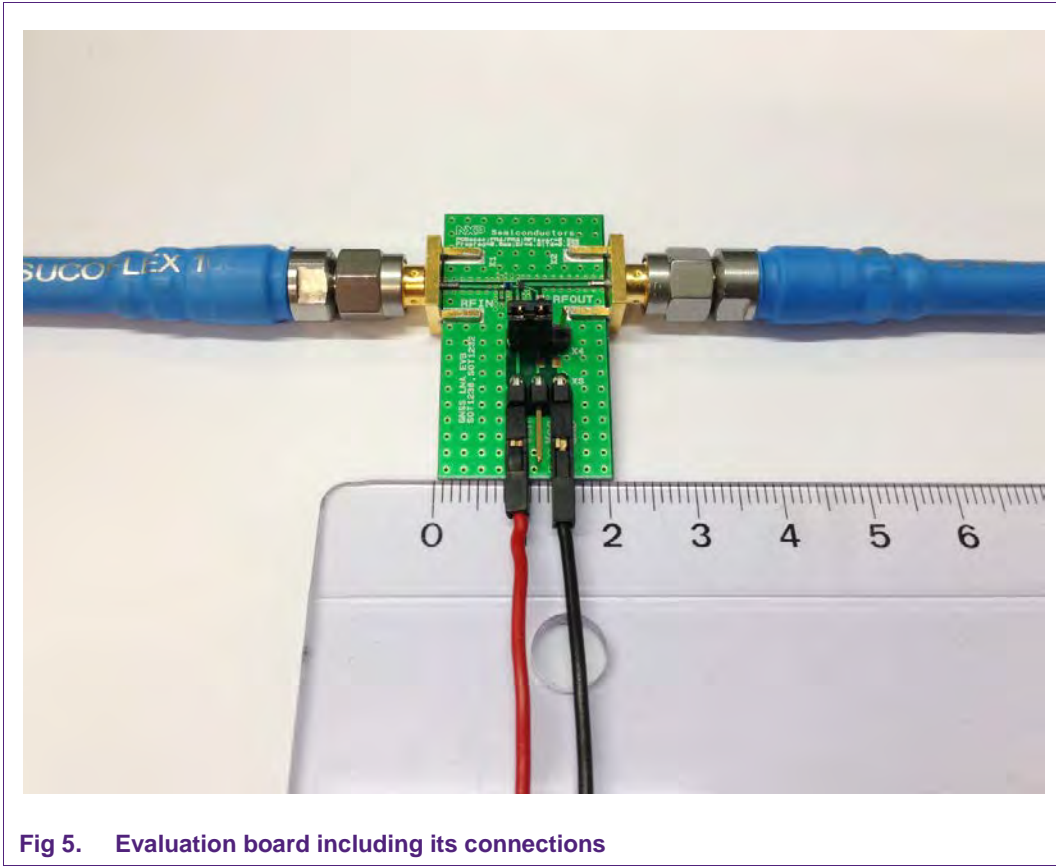

Fig 5. Evaluation board including its connections

7. Linearity

At the average power levels of -130 dBm that have to be received by a GNSS receiver, the system will not have in-band intermodulation problems caused by the GNSS-signal itself. Strong out-of-band cell phone TX jammers however can cause linearity problems, and result in third-order intermodulation products in the GNSS frequency band. In this chapter the effects of these Jammer-signals on the Noise and Gain performance of the BGU8019 are described. The effect of these Jammers on the In-band and Out-of-Band Third-Order Intercept points are described in more detail in a separate User Manual: UM10453: 2-Tone Test BGU7005 and BGU7007 GNSS LNA.

7.1 In-band 1dB gain compression due to 787MHz, 850MHz and 1850MHz jammers

As stated before, signal levels in the GNSS frequency band of -130 dBm average will not cause linearity problems in the GNSS band itself. This of course is also valid for the 1dB gain compression in-band. The 1dB compression point at 1575.42MHz caused by cell phone TX jammers however is important.

Measurements have been carried out using the setup shown in Fig 6.

For the measurements, a BGU8019-LNA EVB is used. Due to the small difference in package between the BGU8019, the performance of both types will be the same.

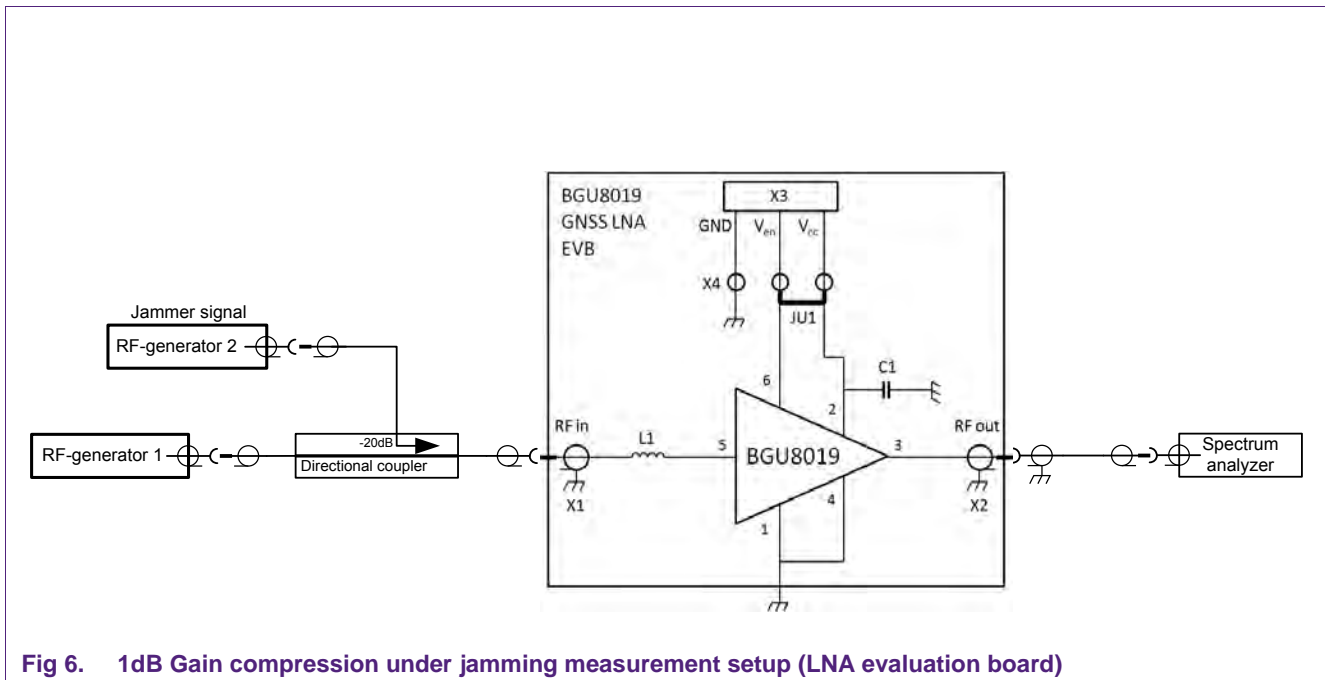
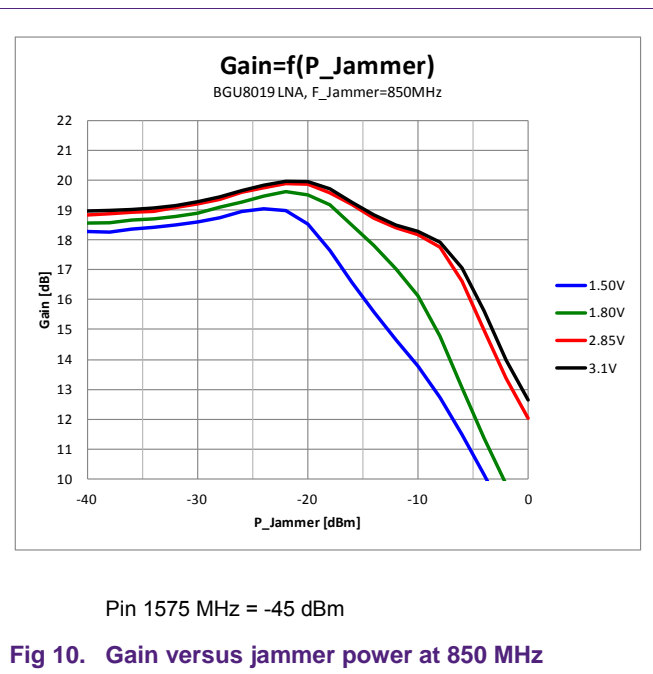
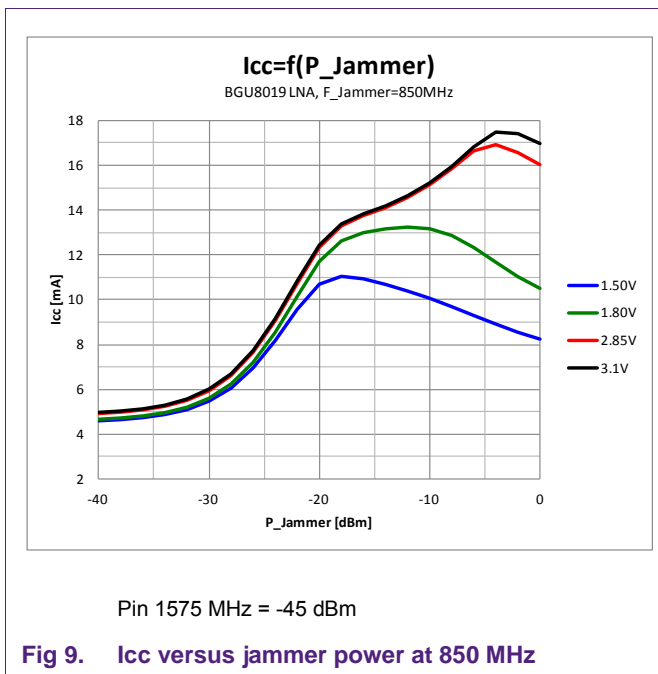
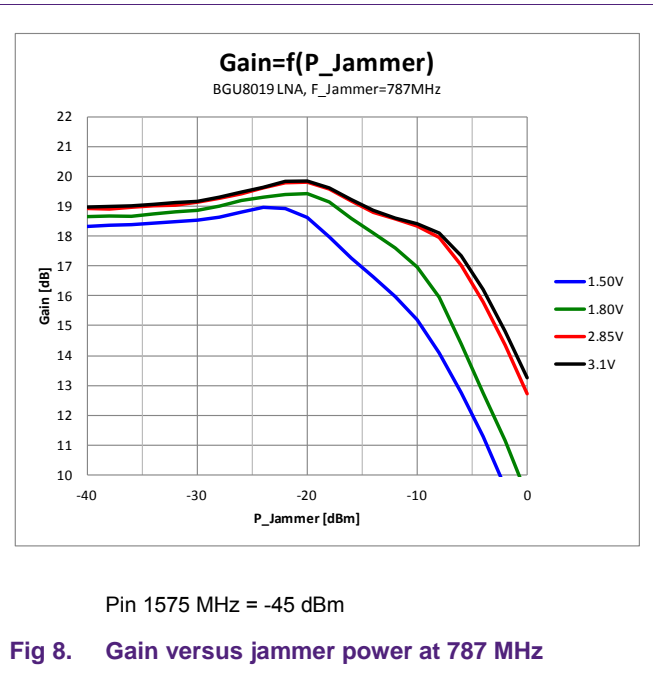
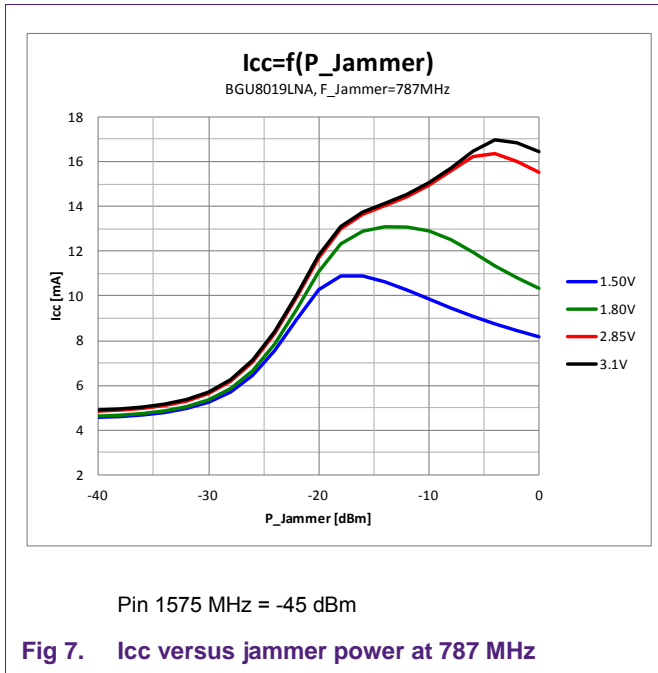

Fig 6. 1dB Gain compression under jamming measurement setup (LNA evaluation board)

The gain of the DUT was measured between port RFin and RFout of the EVB at the GNSS frequency 1575 MHz, while simultaneously a jammer power signal was swept at the 20dB attenuated input port of the Directional Coupler. Please note that the drive power of the jammer is 20 dB lower at the input of the DUT caused by the directional coupler.

The figures below show the supply-current (I_{cc}) and gain compression curves with 787MHz, 850MHz and 1850 MHz jammers (input jammer power at LNA-board, taking into account the approx 20 dB attenuation of the directional coupler and RF-cable from Jammer-Generator to the directional coupler).

The gain drops 1dB with approximately -12 dBm input jamming power at 787MHz and 850MHz ($V_{cc}=1.8V$) (Fig 8 and Fig 10). With an 1850MHz jamming signal, the 1dB gain compression occurs around -11 dBm input power level (Fig 12).



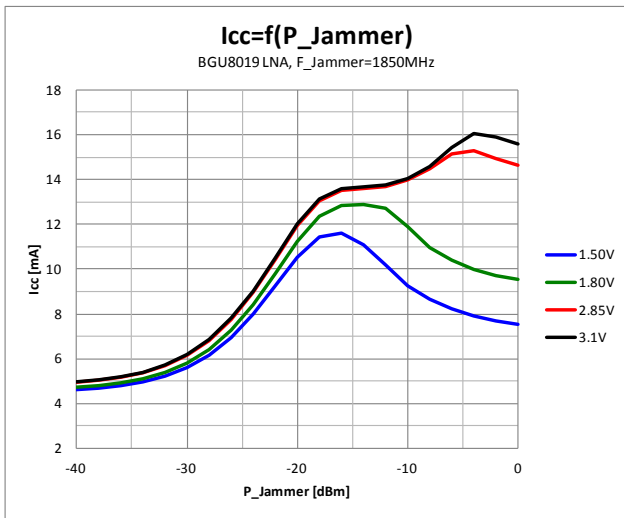

Pin 1575 MHz = -45 dBm

Fig 11. Icc versus jammer power at 1850 MHz

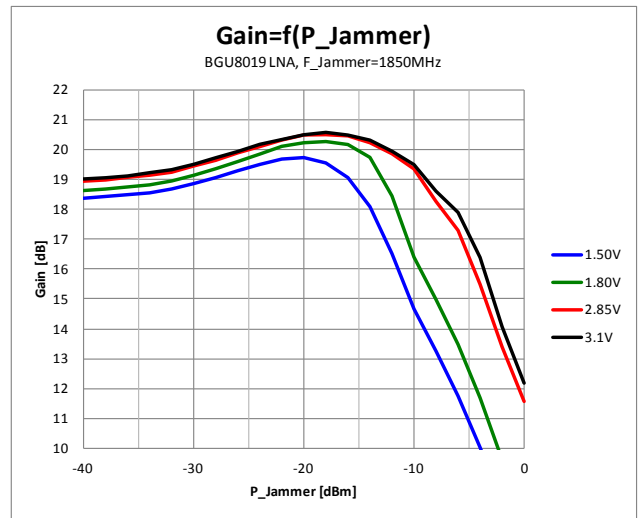

Pin 1575 MHz = -45 dBm

Fig 12. Gain versus jammer power at 1850 MHz

8. Noise figure as function of jammer power at 850MHz and 1850MHz

Noise figure under jamming conditions is a measure of how the LNA behaves when e.g. a GSM TX interfering signal is at the input of the GNSS antenna. To measure this behavior the setup shown in Fig 13 is used.

For the measurements, a BGU8019-LNA EVB is used. Due to the small difference in package between the BGU8019, the performance of both types will be the same.

The jammer signal is coupled via a directional coupler to the DUT: this is to avoid the jammer signal damaging the noise source. The GNSS BPF is needed to avoid driving the second-stage LNA in saturation.

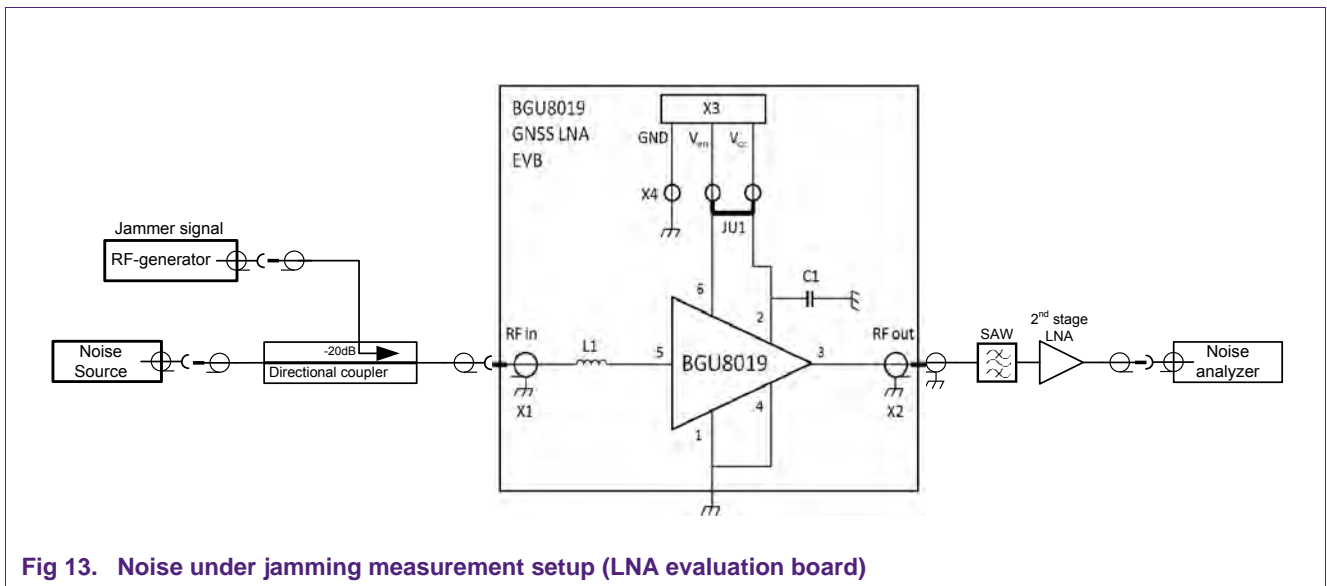
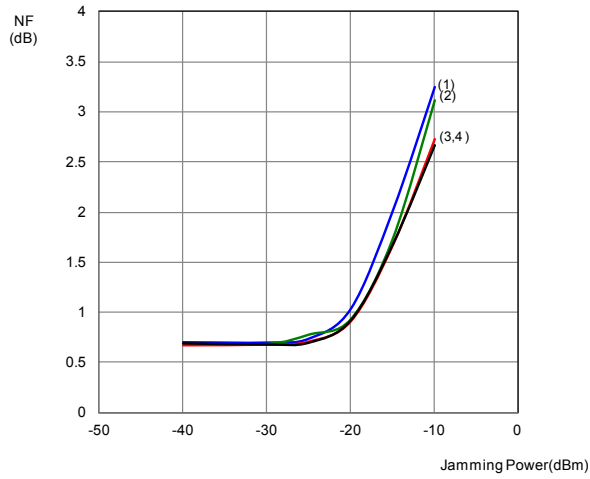

Fig 13. Noise under jamming measurement setup (LNA evaluation board)

With the results of these measurements and the specification of the SAW filter, the jammer power levels that cause noise increase can be calculated.

As can be seen in Fig 14, with a 850 MHz jammer the NF of the LNA starts to increase at $P_{jam} = -25$ dBm (input jammer power at LNA-board, taking into account the approx 20 dB attenuation of the directional coupler and RF-cable from Jammer-Generator to the directional coupler). For the 1850 MHz jammer the NF of the LNA starts to increase at $P_{jam} = -30$ dBm (see Fig 15).



fjam = 850 MHz; Tamb = 25 °C; f = 1575 MHz; including PCB losses.
 (1) Vcc = 1.5 V
 (2) Vcc = 1.8 V
 (3) Vcc = 2.85 V
 (4) Vcc = 3.1 V

Fig 14. NF versus jammer power at 850 MHz

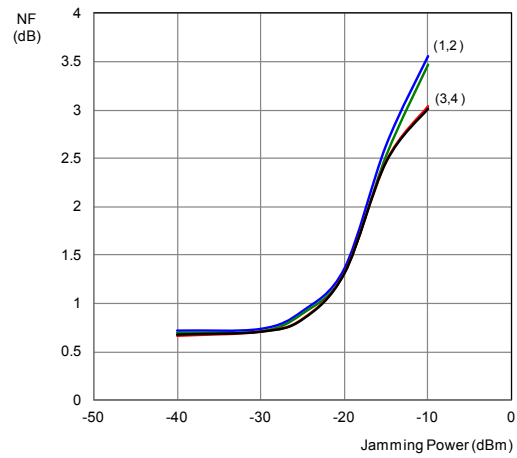

fjam = 1850 MHz; Tamb = 25 °C; f = 1575 MHz; including PCB losses.
 (1) Vcc = 1.5 V
 (2) Vcc = 1.8 V
 (3) Vcc = 2.85 V
 (4) Vcc = 3.1 V

Fig 15. NF versus jammer power at 1850 MHz

9. Typical LNA evaluation board results

Table 2. Typical results measured on the evaluation Board

Operating Frequency is $f = 1575.42$ MHz unless otherwise specified; Temp = 25 °C

Parameter	Symbol	LNA EVB	LNA EVB	LNA EVB	LNA EVB	Unit	Remarks
Supply Voltage	V_{CC}	1.5	1.8	2.85	3.1	V	
Supply Current	I_{CC}	4.2	4.4	4.6	4.8	mA	
Noise Figure	NF	0.65	0.6	0.6	0.6	dB	[1]
Power Gain	G_p	17.5	18	18.5	18.5	dB	
Input Return Loss	RL_{in}	11	12	13	12	dB	
Output Return Loss	RL_{out}	13	13	13	13	dB	
Reverse Isolation	ISO_{rev}	31	30	30	30	dB	
Input 1dB Gain Compression	P_{i1dB}	-13	-10	-7	-7	dBm	
Output 1dB Gain Compression	P_{o1dB}	3.5	7	10.5	10.5	dBm	
Input third order intercept point	IIP3	0	2	6	6	dBm	[2]
Output third order intercept point	OIP3	17.5	20	24.5	24.5	dBm	[2]
Power settling time	T_{on}	<2	< 2	< 2	< 2	μ s	
	T_{off}	<1	< 1	< 1	< 1	μ s	

[1] The noise figure and gain figures are measured at the SMA connectors of the evaluation board. The losses of the connectors and the PCB of approximately 0.05 dB are not subtracted. Measured at $T_{amb} = 25$ °C.

[2] Out of band IP3, jammers at $f_1=f+138$ MHz and $f_2=f+276$ MHz, where $f=1575.42$ MHz. $P_{in}(f_1)=-20$ dBm, $P_{in}(f_2)=-65$ dBm

Table 3. BOM of the BGU8019 with 2 and 3 element LTE rejection input match

Designator	Description	Footprint	Value	Supplier Name/type	Comment
A	BGU8019	1.1 x 0.7 x 0.37mm ³ , 0.4mm pitch		NXP	SOT1232
PCB		20x35mm		BGU8019 GNSS LNA EV Kit	
C1	Capacitor	0402	1nF	Murata GRM1555	Decoupling
C2 (Fig 16)	Capacitor	0402	1.5pF	Murata GRM1555	Input matching
C2 (Fig 17)	Capacitor	0402	1.2pF	Murata GRM1555	Input matching
C3	Capacitor	0402	6.8pF	Murata GRM1555	Notch filter
L1 (Fig 16)	Inductor	0402	5.1nH	Murata LQW15	Input matching
L1 (Fig 17)	Inductor	0402	6.2nH	Murata LQW15	Input matching
X1, X2	SMA RD connector	-	-	Johnson, End launch SMA 142-0701-841	RF input/ RF output
X3	DC header	-	-	Molex, PCB header, Right Angle, 1 row, 3 way 90121-0763	Bias connector
X4	JUMPER	-	-	Molex, PCB header, Vertical, 1 row, 3 way 90120-0763	Connect Ven to Vcc or separate Ven voltage
JU1	JUMPER				

The measurement setup is given in Fig 18. A notch is used to reduce the second harmonic caused by the input generator. A 10dB attenuator is used to get a good 50Ω impedance (some notch-filters have an output-impedance which is not 50Ω over a wide frequency range).

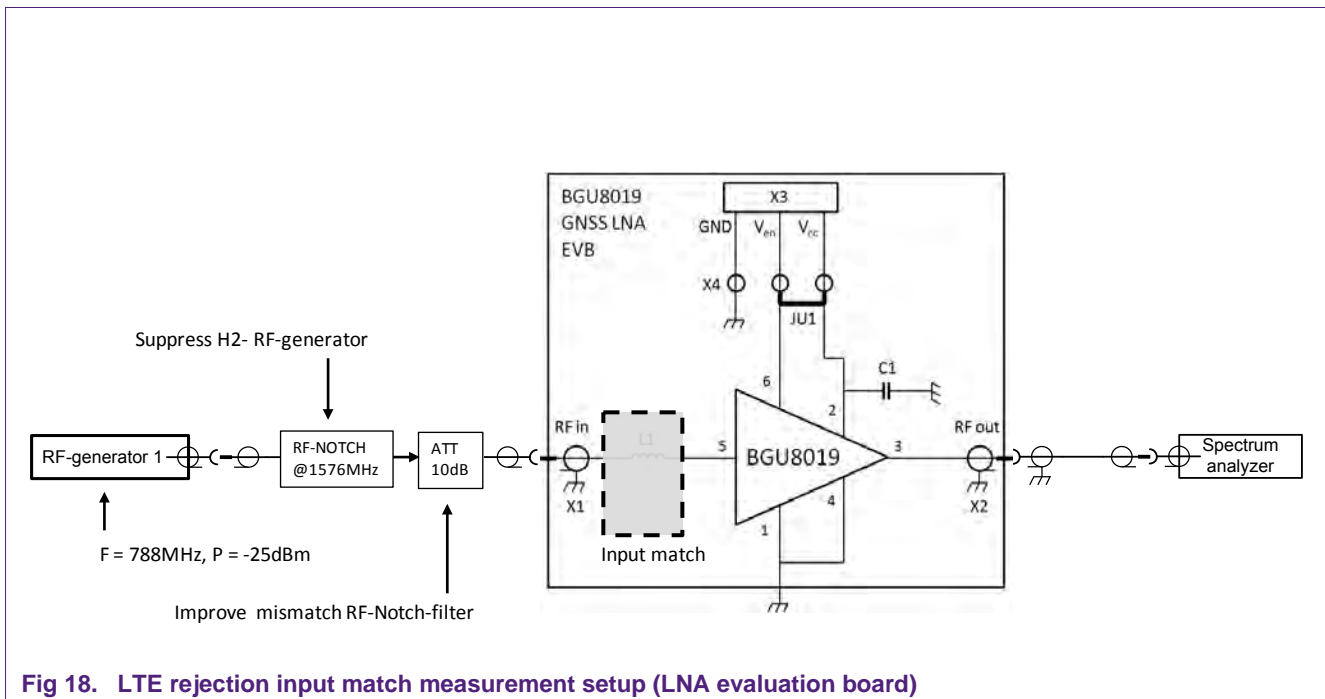

Fig 18. LTE rejection input match measurement setup (LNA evaluation board)

Fig 19 shows the Gain as function of frequency for the default LNA circuit, the 2- and the 3-element LTE-reduction input circuits. Table 4 shows an overview of the measured performance of the 3 input-circuit configurations.

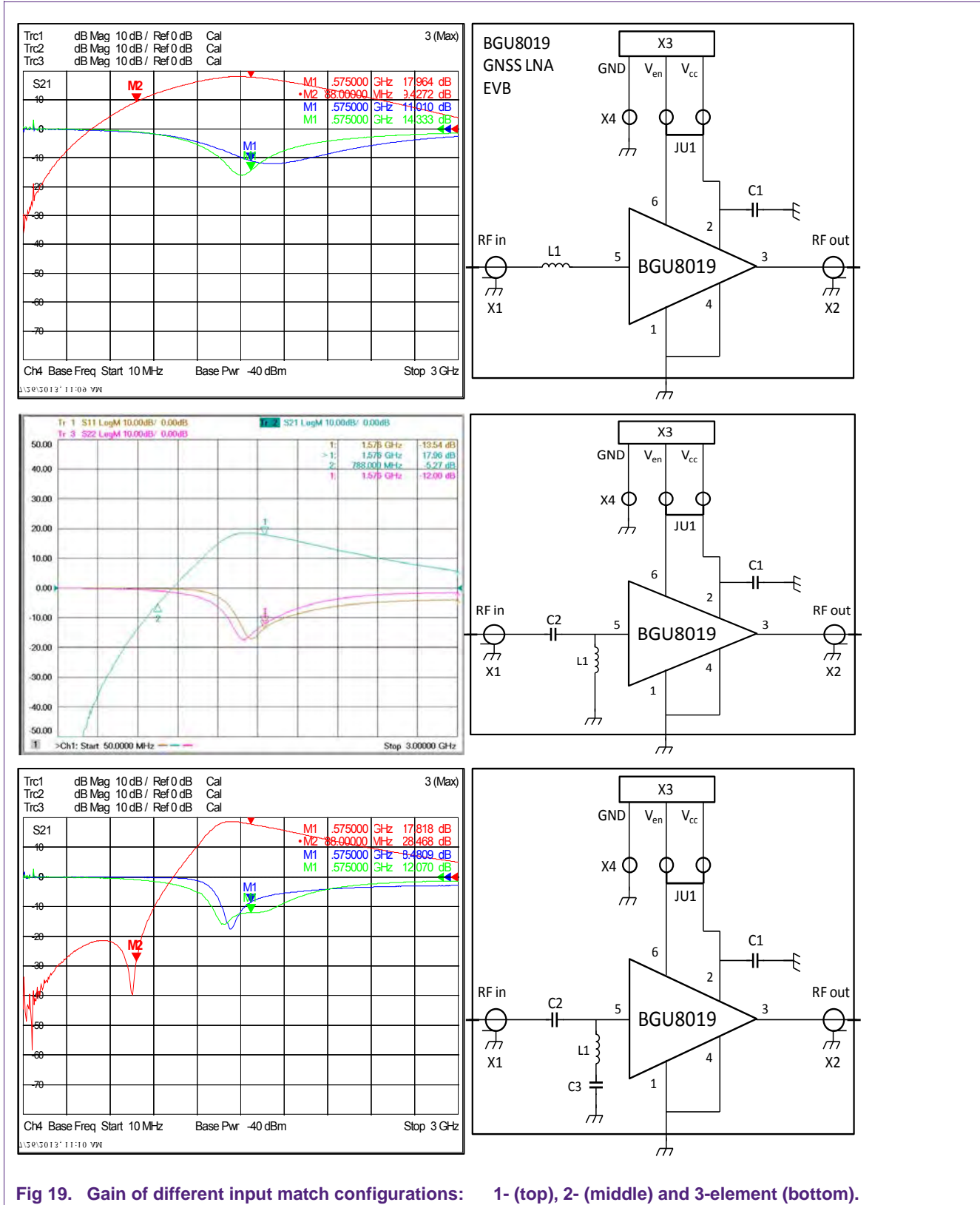

Fig 19. Gain of different input match configurations: 1- (top), 2- (middle) and 3-element (bottom).

Table 4. Measured performance of 3 different input match configurations
 Operating Frequency is $f = 1575.42$ MHz unless otherwise specified; Temp = 25 °C

Parameter	Symbol	Default Input circuit	2 el. inp. LTE rej. circuit	3 el. inp. LTE rej. circuit	Unit	Remarks
Supply Voltage	V_{CC}	1.8	1.8	1.8	V	
Supply Current	I_{CC}	4.4	4.4	4.4	mA	
Noise Figure	NF	0.6	0.7	1.0	dB	[3]
Power Gain	G_p	18.0	17.9	17.8	dB	
Input Return Loss	RL_{in}	12	14	9	dB	
Output Return Loss	RL_{out}	13	12	12	dB	
Reverse Isolation	ISO_{rev}	30			dB	
P_H2 (input referred)	P_H2	-47	-65	-126	dBm	[4]
Input 1dB Gain Compression	P_{i1dB}	-10	-10	-10	dBm	
Output 1dB Gain Compression	P_{o1dB}	7	7	7	dBm	
Input third order intercept point	IIP3	2			dBm	[5]
Output third order intercept point	OIP3	20			dBm	[5]

[3] The noise figure and gain figures are measured at the SMA connectors of the evaluation board. The losses of the connectors and the PCB of approximately 0.05 dB are not subtracted. Measured at $T_{amb} = 25$ °C.

[4] $F_{in} = 788$ MHz, $P_{in} = -25$ dBm

[5] Out of band IP3, jammers at $f_1=f+138$ MHz and $f_2=f+276$ MHz, where $f=1575.42$ MHz. $P_{in}(f_1)=-20$ dBm, $P_{in}(f_2)=-65$ dBm

11. Legal information

11.1 Definitions

Draft — The document is a draft version only. The content is still under internal review and subject to formal approval, which may result in modifications or additions. NXP Semiconductors does not give any representations or warranties as to the accuracy or completeness of information included herein and shall have no liability for the consequences of use of such information.

11.2 Disclaimers

Limited warranty and liability — Information in this document is believed to be accurate and reliable. However, NXP Semiconductors does not give any representations or warranties, expressed or implied, as to the accuracy or completeness of such information and shall have no liability for the consequences of use of such information. NXP Semiconductors takes no responsibility for the content in this document if provided by an information source outside of NXP Semiconductors.

In no event shall NXP Semiconductors be liable for any indirect, incidental, punitive, special or consequential damages (including - without limitation - lost profits, lost savings, business interruption, costs related to the removal or replacement of any products or rework charges) whether or not such damages are based on tort (including negligence), warranty, breach of contract or any other legal theory.

Notwithstanding any damages that customer might incur for any reason whatsoever, NXP Semiconductors' aggregate and cumulative liability towards customer for the products described herein shall be limited in accordance with the Terms and conditions of commercial sale of NXP Semiconductors.

Right to make changes — NXP Semiconductors reserves the right to make changes to information published in this document, including without limitation specifications and product descriptions, at any time and without notice. This document supersedes and replaces all information supplied prior to the publication hereof.

Suitability for use — NXP Semiconductors products are not designed, authorized or warranted to be suitable for use in life support, life-critical or safety-critical systems or equipment, nor in applications where failure or malfunction of an NXP Semiconductors product can reasonably be expected to result in personal injury, death or severe property or environmental damage. NXP Semiconductors and its suppliers accept no liability for inclusion and/or use of NXP Semiconductors products in such equipment or applications and therefore such inclusion and/or use is at the customer's own risk.

Applications — Applications that are described herein for any of these products are for illustrative purposes only. NXP Semiconductors makes no representation or warranty that such applications will be suitable for the specified use without further testing or modification.

Customers are responsible for the design and operation of their applications and products using NXP Semiconductors products, and NXP Semiconductors accepts no liability for any assistance with applications or customer product design. It is customer's sole responsibility to determine whether the NXP Semiconductors product is suitable and fit for the customer's applications and products planned, as well as for the planned application and use of customer's third party customer(s). Customers should provide appropriate design and operating safeguards to minimize the risks associated with their applications and products.

NXP Semiconductors does not accept any liability related to any default, damage, costs or problem which is based on any weakness or default in the customer's applications or products, or the application or use by customer's third party customer(s). Customer is responsible for doing all necessary testing for the customer's applications and products using NXP Semiconductors products in order to avoid a default of the applications and the products or of the application or use by customer's third party customer(s). NXP does not accept any liability in this respect.

Export control — This document as well as the item(s) described herein may be subject to export control regulations. Export might require a prior authorization from national authorities.

Evaluation products — This product is provided on an "as is" and "with all faults" basis for evaluation purposes only. NXP Semiconductors, its affiliates and their suppliers expressly disclaim all warranties, whether express, implied or statutory, including but not limited to the implied warranties of non-infringement, merchantability and fitness for a particular purpose. The entire risk as to the quality, or arising out of the use or performance, of this product remains with customer.

In no event shall NXP Semiconductors, its affiliates or their suppliers be liable to customer for any special, indirect, consequential, punitive or incidental damages (including without limitation damages for loss of business, business interruption, loss of use, loss of data or information, and the like) arising out of the use of or inability to use the product, whether or not based on tort (including negligence), strict liability, breach of contract, breach of warranty or any other theory, even if advised of the possibility of such damages.

Notwithstanding any damages that customer might incur for any reason whatsoever (including without limitation, all damages referenced above and all direct or general damages), the entire liability of NXP Semiconductors, its affiliates and their suppliers and customer's exclusive remedy for all of the foregoing shall be limited to actual damages incurred by customer based on reasonable reliance up to the greater of the amount actually paid by customer for the product or five dollars (US\$5.00). The foregoing limitations, exclusions and disclaimers shall apply to the maximum extent permitted by applicable law, even if any remedy fails of its essential purpose.

11.3 Trademarks

Notice: All referenced brands, product names, service names and trademarks are property of their respective owners.

12. List of figures

Fig 1.	BGU8019 GNSS LNA evaluation board.....	3
Fig 2.	Circuit diagram of the BGU8019LNA evaluation board.....	5
Fig 3.	Printed-Circuit Board layout of the BGU8019LNA evaluation board.....	6
Fig 4.	Stack of the PCB material.....	7
Fig 5.	Evaluation board including its connections	10
Fig 6.	1dB Gain compression under jamming measurement setup (LNA evaluation board)...	11
Fig 7.	Icc versus jammer power at 787 MHz.....	12
Fig 8.	Gain versus jammer power at 787 MHz.....	12
Fig 9.	Icc versus jammer power at 850 MHz.....	12
Fig 10.	Gain versus jammer power at 850 MHz.....	12
Fig 11.	Icc versus jammer power at 1850 MHz.....	13
Fig 12.	Gain versus jammer power at 1850 MHz.....	13
Fig 13.	Noise under jamming measurement setup (LNA evaluation board).....	14
Fig 14.	NF versus jammer power at 850 MHz.....	15
Fig 15.	NF versus jammer power at 1850 MHz.....	15
Fig 16.	LNA EVB with 2 element LTE rejection input match	17
Fig 17.	LNA EVB with 3 element LTE rejection input match	17
Fig 18.	LTE rejection input match measurement setup (LNA evaluation board).....	18
Fig 19.	Gain of different input match configurations: 1- (top), 2- (middle) and 3-element (bottom) ...	20

13. List of tables

Table 1. BOM of the BGU8019 GNSS LNA evaluation board.....8

Table 2. Typical results measured on the evaluation Board 16

Table 3. BOM of the BGU8019 with 2 and 3 element LTE rejection input match..... 18

Table 4. Measured performance of 3 different input match configurations.....21

14. Contents

1.	Introduction	3
2.	General description.....	4
3.	BGU8019 GNSS LNA evaluation board	4
3.1	Application Circuit	5
3.2	PCB Layout.....	6
4.	Bill of materials.....	8
4.1	BGU8019	8
4.2	Series inductor	8
5.	Required Equipment	9
6.	Connections and setup.....	9
7.	Linearity	11
7.1	In-band 1dB gain compression due to 787MHz, 850MHz and 1850MHz jammers.....	11
8.	Noise figure as function of jammer power at 850MHz and 1850MHz	14
9.	Typical LNA evaluation board results	16
10.	LTE rejection input match	17
11.	Legal information	22
11.1	Definitions	22
11.2	Disclaimers.....	22
11.3	Trademarks.....	22
12.	List of figures.....	23
13.	List of tables	24
14.	Contents.....	25

Please be aware that important notices concerning this document and the product(s) described herein, have been included in the section 'Legal information'.

© NXP B.V. 2014.

All rights reserved.

For more information, visit: <http://www.nxp.com>

For sales office addresses, please send an email to: salesaddresses@nxp.com

Date of release: 21 February 2014

Document identifier: AN11368