

# USB Bootloader for the MC9S08JM60

by: Patrick Yang  
Asia & Pacific Operation Microcontroller Division

## 1 Introduction

This application note describes a bootloader for the MC9S08JM60 allowing in-circuit reprogramming of the flash memory via a universal serial bus (USB).

In-circuit programming (ICP) is a process where the MCU is programmed or erased on the printed circuit board that is the target system. This allows the user code to be changed during product development, production, and code upgrades.

The MC9S08JM60 provided by Freescale Semiconductor is a member of the low-cost, high-performance HCS08 family of 8-bit microcontroller units (MCUs). It has a 60 KB embedded flash memory that can be programmed or erased without special voltage input. In-circuit programming is possible through several communication paths. The MC9S08JM60 has a USB 2.0 full-speed module, making this MCU suitable for in-circuit programming via a USB interface. The USB speed is fast and can program 60 KB flash in 2–3 seconds, faster than a BDM cable.

## Contents

1	Introduction	1
2	Bootloader Overview	2
2.1	Resources for the Bootloader	2
2.2	Flash Memory Protection	3
2.3	Vector Redirection	3
2.4	Software Startup Process	4
2.5	PC Driver and PC GUI Tool	7
3	Tutorial for Bootloader Implementation	7
3.1	Software Integration	8
3.2	PC Driver Installation	10
3.3	Running PC GUI Tool	12
4	Conclusions	17
	Appendix A Example Project	18

## Bootloader Overview

The flash based bootloader code can be divided into three functional groups:

- A USB low-level driver to enumerate and transfer information between the board and PC
- Command interpretation and .s19 information data download
- Flash program and erase operations

Figure 1 shows the system environment for a USB bootloader.

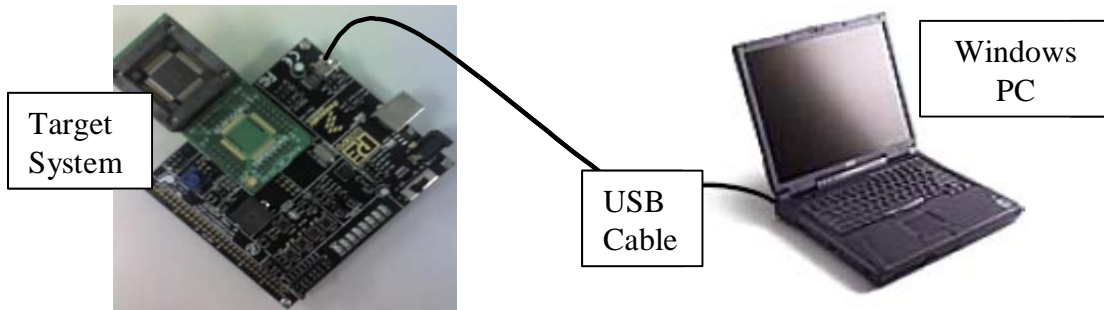

Figure 1. System Environment

The PC and target system communicate via a USB interface with Freescale Semiconductor specific USB protocol. The target system acts as a USB device and the PC as a USB host. The PC programs the target system described in [Section 2.5, “PC Driver and PC GUI Tool.”](#)

## 2 Bootloader Overview

### 2.1 Resources for the Bootloader

The bootloader uses as few MCU resources as possible to minimize the impact in an application.

- USB module — The USB interrupt is not used in the bootloader. Only the control transfer endpoint is used (endpoint 0).
- Memory footprint — The bootloader makes efficient use of memory. The code is less than 1 KB and uses only 70 bytes of RAM. The RAM has 11 bytes of bootloader variables and 59 bytes are used for flash programming/erasing. The command for programming/erasing flash must be executed from the RAM.

Figure 2 shows the MC9S08JM60 memory map and the bootloader memory footprint. Bootloader variables are located in address 0x00B0 to 0x00BA. The bootloader code resides in the end address of the flash memory, 0xFC00 to 0xFFAF.

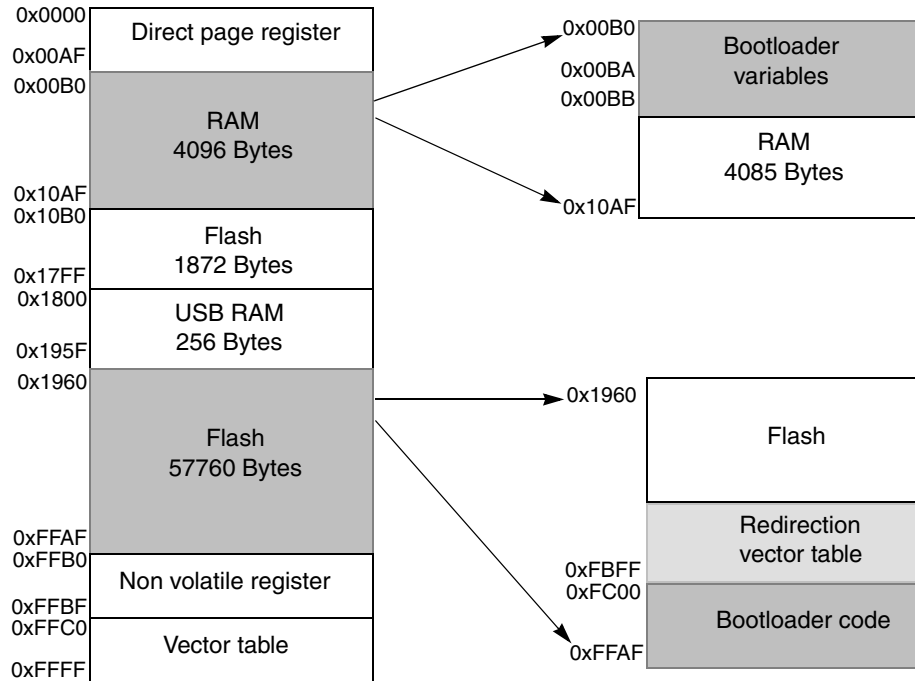

Figure 2. Memory Map

## 2.2 Flash Memory Protection

The flash memory (address 0xFC00–0xFFAF) must be protected to avoid accidentally erasing the bootloader code. The flash protection register controls the MC9S08JM60 flash memory protection. Block protection begins if the protection is enabled at 512 bytes boundary below the flash memory’s last address. For example, the flash memory with the address 0xFC00 through 0xFFFF is protected if the value 0xFA is set to the flash protection register. It is your responsibility to program the NVPROT register to protect the bootloader code. For detailed information on the protection mechanism, please refer to Section 4.5.6 of the MC9S08JM60 data sheet.

## 2.3 Vector Redirection

If the flash memory protection mechanism is enabled, the vector table (address 0xFFC0–0xFFFF) cannot be updated. All vectors except for reset, must be redirected to the proper addresses for the interrupt service subroutines in the user code. The MC9S08JM60 supports vector redirection if the FNORED bit in the NVOPT is programmed to zero. For example, if the flash memory with the address 0xFC00–0xFFFF is protected, the clear FNORED bit redirects the vector table from 0xFFC0–0xFFFD to the location 0xFBC0–0xFBFD. It is your responsibility to program the FNORED bit to redirect the vector table. For detailed information on the vector redirection mechanism, please refer to Section 4.5.7 of the MC9S08JM60 data sheet.

## 2.4 Software Startup Process

Figure 3 shows the bootloader startup process.

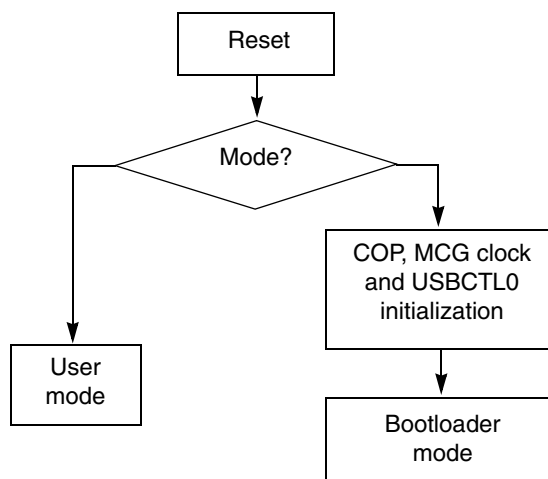

Figure 3. Bootloader Startup Process

Upon reset, a small amount of code is executed to determine the mode of operation. In the example bootloader application project, refer to [Appendix A, “Example Project,”](#) a general-purpose input/output PTG0 is used for mode determination. If the PTG0 is high, the target system enters user mode, otherwise it enters the bootloader mode.

### 2.4.1 User Mode

A jump instruction is executed and jumps to the user application code when the target system enters user mode. The user application code is located in an unprotected flash memory area (0x1960–0xFBFF).

The user application code entry address can vary every time the linker builds the project. The mode determination code resides in a protected flash memory, and the code cannot be updated. The user mode absolute entry address must be provided to the bootloader. Figure 4 shows an example of how to jump to the user application code using the absolute entry address of the user mode in 0xFB00. If the user mode is determined, the instruction `JMP 0xFB00` is executed to jump to address 0xFB00. At address 0xFB00, another `JMP` instruction calls `_Startup()` function to run the user application code. This makes the system jump to address 0xFB00 and enter user mode no matter where the `_Startup()` is.

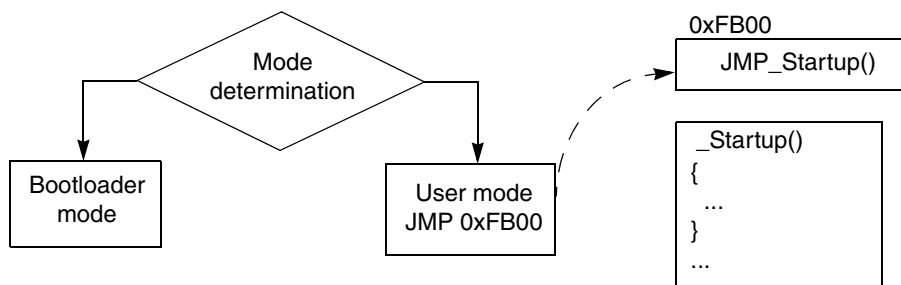

Figure 4. User Mode Fixed Entry Address

The `_Startup()` is a standard C programming startup function. It is your responsibility to completely configure the device.

## 2.4.2 Bootloader Initialization

You must take the following steps before the MCU enters the bootloader mode:

1. Disable computer operating properly (COP) before entering the bootloader mode.

The COP may lead to a USB enumeration failure and flash programming/erase error. The COPT bits can be set in the system options register 1 (SOPT1) to disable the COP. For detailed information on setting the COP, please refer to Section 5.4 of the MC9S08JM60 data sheet.

### NOTE

SOPT1 is a write-once register. To use the COP in the application, set SOPT1 register after the mode determination.

2. Set the multi-purpose clock generator (MCG).

The MC9S08JM60's USB module requires two clock sources, a 24 MHz bus clock and a 48 MHz reference clock. The 48 MHz reference clock is sourced directly from the MCGOUT. For USB operation on the MC9S08JM60, the MCG must be configured as PLL engaged external (PEE) mode using an external crystal to achieve an MCGOUT frequency of 48 MHz. For detailed information, refer to Chapter 12 of the MC9S08JM60 data sheet.

3. Set the on-chip regulator and the USBDP pullup.

The MC9S08JM60 has a 3.3 V on-chip voltage regulator that provides a stable power source to power the USB internal transceiver. If the on-chip regulator is enabled, it requires a voltage supply ( $V_{DD}$ ) of 3.9 V to 5.5 V. The MCU and USB can operate at different voltages, if the on-chip 3.3 V regulator is disabled. A 3.3 V source must be provided through the  $V_{USB33}$  pin to power the USB transceiver.

The pullup resistor on the USBDP line is required for full-speed operation by the USB specification Rev. 2.0. An on-chip pullup resistor is implemented in the MC9S08JM60 USB module. This on-chip pullup resistor can also be disabled, and the USB module can be configured to use an external pullup resistor for the USBDP line.

To configure the on-chip regulator and the on-chip pull up resistor, set or clear the USBPU bit and USBVREN bit in the USBCTL0 register. This step must occur before entering bootloader mode. The bootloader code retains this information when it updates the other bits in the USBCTL0 register. [Table 1](#) summarizes how to configure the USBCTL0 register before it enters bootloader mode. For detailed on-chip regulator and on-chip pullup resistor information, please refer to Section 17.3.1 of the MC9S08JM60 data sheet.

**Table 1. USBCTL0 Configuration for Different Applications**

3.3 V Voltage Regulator	USBDP Pullup Resistor	USBCTL0 Setting
Internal	Internal	0x44
Internal	External	0x04
External	Internal	0x40
External	External	0x00

If the startup process is modified, care must be taken to configure SOPT1, MCG, and USBCTL0. Improper configuration may lead to a bootloader malfunction and damage the target system.

### 2.4.3 Bootloader Mode

Figure 5 shows the bootloader mode software flowchart. The USB enumeration starts after the USB cable is plugged in. There is a request to install a PC Driver the first time the USB cable is plugged in. If the enumeration succeeds, the target system is identified as an MC9S08JM60 USB ICP device. A PC GUI Tool can then be used for in-circuit programming. The PC Driver and PC GUI Tool is explained in Section 2.5, “PC Driver and PC GUI Tool.”

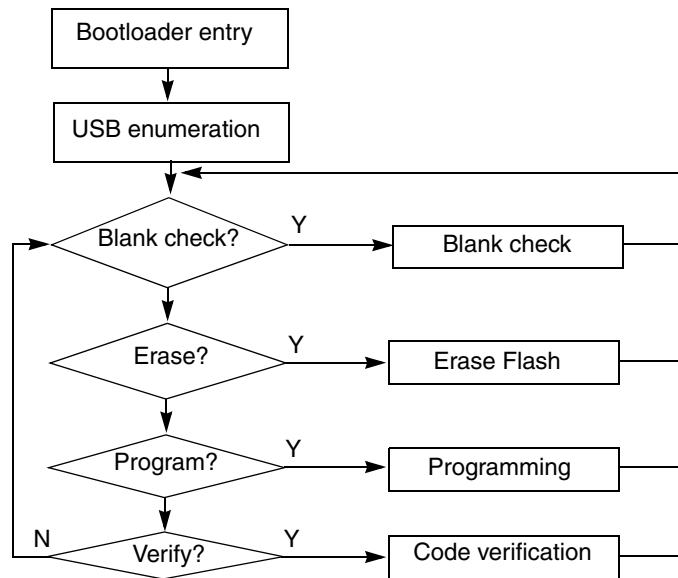

**Figure 5. Bootloader Mode Flowchart**

The bootloader mode code is available in the source code and the object binary library. The interface between the user code and library is called `Bootloader_Main()`. The target system enters bootloader mode by calling the `Bootloader_Main()` function. This code must be located in the flash memory (address 0xFC00–0xFFAF) while compiling and linking. To exit bootloader mode a power-on-reset (POR) must be conducted.

## NOTE

If using the bootloader code in the library, format the `Bootloader_Main ()`. This is the entry function that cannot be changed.

## 2.5 PC Driver and PC GUI Tool



Figure 6. USB PC GUI Tool

The PC driver is the USB bootloader driver. If the PC driver is not installed the PC does not recognize the JM60 in the bootloader mode. The PC tool sends commands to the target system to program or erase. Figure 6 shows the snapshot of this PC Tool. The PC driver and PC tool for the USB bootloader is integrated in JM60 GUI software. You can download the JM60\_GUI from the [www.freescale.com](http://www.freescale.com) website. Details to use this tool are explained in Section 3.3, “Running PC Tool.”

## 3 Tutorial for Bootloader Implementation

This section details the USB bootloader implement procedure for the MC9S08JM60. An example project is provided for reference in Appendix A, “Example Project.” This example project can be used as a template to create a project. Please see AN3561SW for a CodeWarrior project containing the software.

### 3.1 Software Integration

The compiler for the bootloader application is CodeWarrior for the HC(S)08, version 5.1 or above. The following steps show how to create a simple project with the bootloader supported.

1. Create a new project  
Use CodeWarrior new project wizard to create a new project for the MC9S08JM60.
2. Modify the prm link file as shown in [Figure 7](#)
  - a) Flash address 0xFC00-0xFFAF is reserved for the bootloader code. The bootloader code segment named Bootloader\_ROM is placed in this area.

**NOTE**

The bootloader segment must be named Bootloader\_ROM to compile the bootloader into the protected flash address 0xFC00-0xFFAF.

- b) The RAM addresses 0xB0 to 0xBA are used as bootloader variables. The start address of Z\_RAM must be changed to 0xBB.
- c) Modify reset vector. Use the \_Entry function instead of \_Startup function as the VECTOR 0. Comment out \_Startup function and add the \_Entry function.

```

SEGMENTS /* Here all RAM/ROM areas of the device are listed. Used in PLAC
ROM = READ_ONLY 0x1960 TO 0xFFFF;
Bootloader = READ_ONLY 0xFC00 TO 0xFFAF;
Z_RAM = READ_WRITE 0x00BB TO 0x00FF;
RAM = READ_WRITE 0x0100 TO 0x10AF;
RAM1 = READ_WRITE 0x1860 TO 0x195F;
ROM1 = READ_ONLY 0x10B0 TO 0x17FF;
ROM2 = READ_ONLY 0xFFC0 TO 0xFFC3;
END

PLACEMENT /* Here all predefined and user segments are placed into the SE
DEFAULT_RAM INTO RAM, RAM1;
DEFAULT_ROM, ROM_VAR, STRINGS INTO ROM; /* ROM1, ROM2 In case
DATA_ZEROPAGE, MY_ZEROPAGE INTO Z_RAM;
Bootloader_ROM INTO Bootloader;
END

STACKSIZE 0x50

//VECTOR 0 _Startup /* Reset vector: this is the default entry point for
VECTOR 0 _Entry

```

Figure 7. Modify prm File

3. Initialize NV registers

The NVOPT and NVPROT register must be initialized for flash block protection and vector table redirection. Use the commands shown in [Figure 8](#) to initialize the NV registers.

```

const byte NVOPT_INIT @0x0000FFBF = 0x02; // vector redirect, flash unsecure
const byte NVPROT_INIT @0x0000FFBD = 0xFA; // 0xFC00-0xFFFF are protected

```

Figure 8. Initialize NV Registers



### NOTE

The NVOPT and NVPROT registers are located in the nonvolatile memory. They can be written once and it must be the first lines of the code. Please refer to [Appendix A, “Example Project.”](#)

#### 4. Load the bootloader library to the project

Select CodeWarrior menu Project -> Add Files as shown in [Figure 9](#) and add the JM60\_Bootloader\_Vx.y.lib to the library.

The bootloader library is named JM60\_Bootloader\_Vx.y.lib. The Vx.y is the version number. This library can be found in the folder \Template with Bootloader\Sources\.

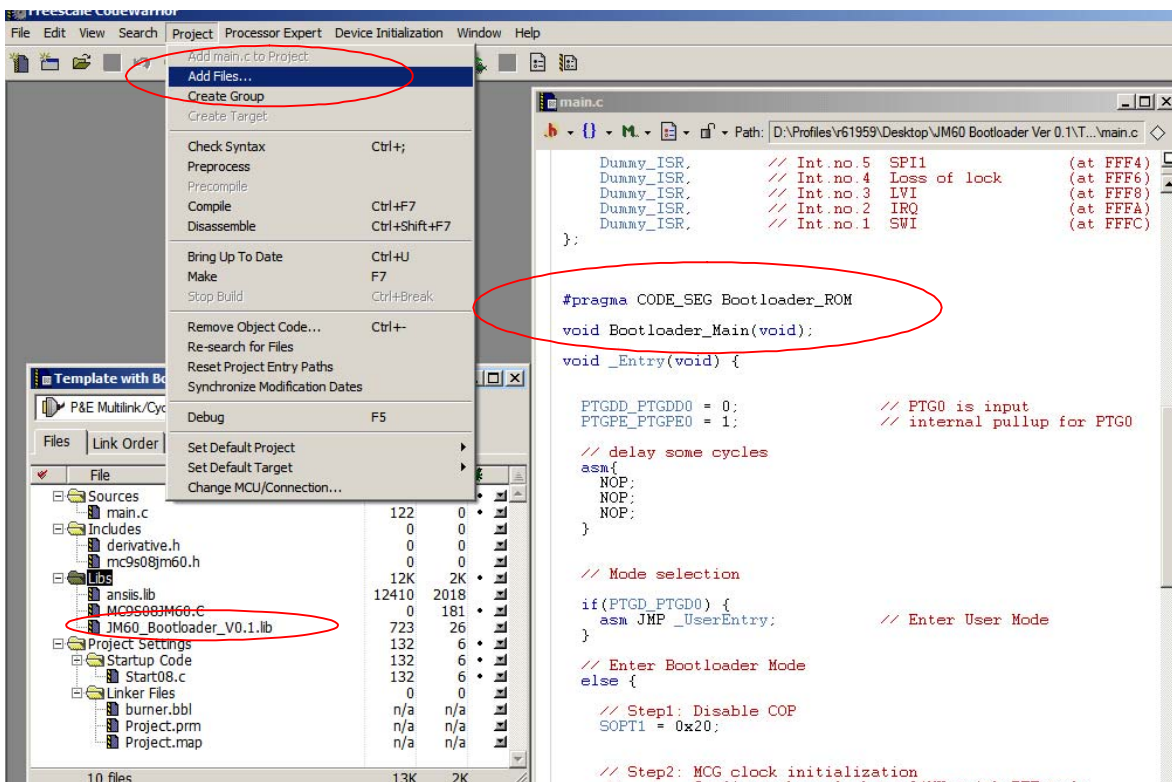

Figure 9. \_Entry Function

5. Mode determination

Figure 9 shows an example on how to determine a mode. An I/O port PTG0 is configured as input. If the PTG0 is logic 1 during the startup period, the target system enters the user mode. Otherwise, the bootloader initializes and enters the bootloader mode.

6. Fix the user mode entry address

Please refer to Section 2.4.1, “User Mode,” for how to fix the user mode entry address.

7. Bootloader initialization

To ensure that the code is located in the protected flash area, a segment declaration #pragma CODE\_SEG Bootloader\_ROM must be set before the entry function. The bootloader initialization must include the COP disable, MCG clock, and the USBCTL0 register initialization.

Compile and link the project after all the steps are finished. Read the .map file to check whether the bootloader code is located in the protected flash address. The application code can now be added to this project.

### 3.2 PC Driver Installation

The software must be downloaded to the target system after the project is built. The software must be downloaded by other tools such as the BDM multilink because the target system has no bootloader code. Please refer to *Development Support of HCS08 Family Reference Manual*, (chapter 7) about the BDM multilink.

These are steps to install the PC Driver:

1. Start the target system, choose to enter bootloader mode. The driver install window appears when the USB cable is plugged in as shown in Figure 10. Select Install from a list or a specific location (Advanced) and then click Next.



Figure 10. Driver Install Window

- Specify the directory C:\Program Files\Freescale\Freescale JM60 GUI\JM60 USB Driver\ that contains the BOOTLOADER winusb.inf file and then click Next, see [Figure 11](#).

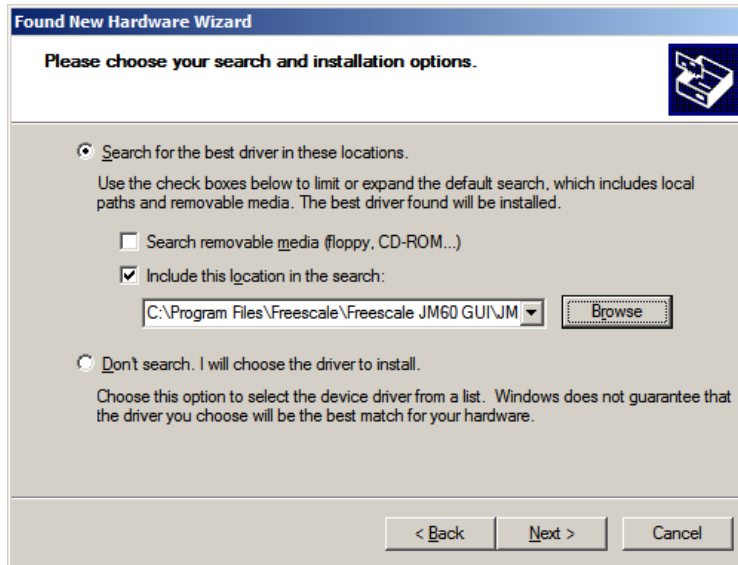

**Figure 11. Locate BOOTLOADER winusb.inf File**

- If the window as shown in [Figure 12](#) appears, locate the directory containing C:\Program Files\Freescale\Freescale JM60 GUI\JM60 USB Driver\i386\ containing the file WinUSBCoInstaller.dll.

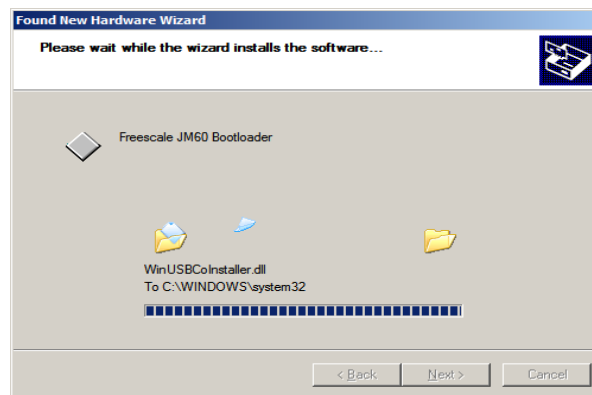

**Figure 12. Install USBICP.sys File**

- [Figure 13](#) shows how the interface appears. Click Finish to complete the installation.



Figure 13. Driver Install Finish

### 3.3 Running PC Tool

The PC Tool is used for programming and erasing. Please see below instructions.

#### 3.3.1 Launch PC Tool

Figure 14 shows how to launch the PC tool from Start menu -> Programs -> Freescale -> JM60 USB GUIs -> Freescale JM60 GUI. Figure 15 shows how the JM60 GUI appears.

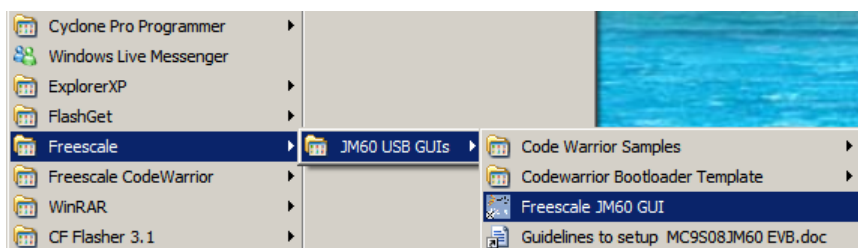

Figure 14. Launch PC Toll



Figure 15. JM60 GUI

Click Bootloader to enter the bootloader GUI as shown in Figure 16. If JM60 is in bootloader mode, the USB icon at the bottom right corner is green.



Figure 16. JM60 USB Bootloader

If JM60 is not in bootloader mode, the USB icon appears in red, see Figure 17. Please check whether the USB enumeration succeeds. If the USB enumeration succeeds, the Freescale JM60 Bootloader can be seen from the Windows device manager as shown in Figure 18. Check the following if the enumeration fails:

- USB cable is plugged in
- MCG output 48 MHz clock
- COP disable
- USBCTL0 is configured as listed in Table 1
- Call Bootloader\_Main() function
- Driver is installed



Figure 17. JM60 Not in Bootloader Mode

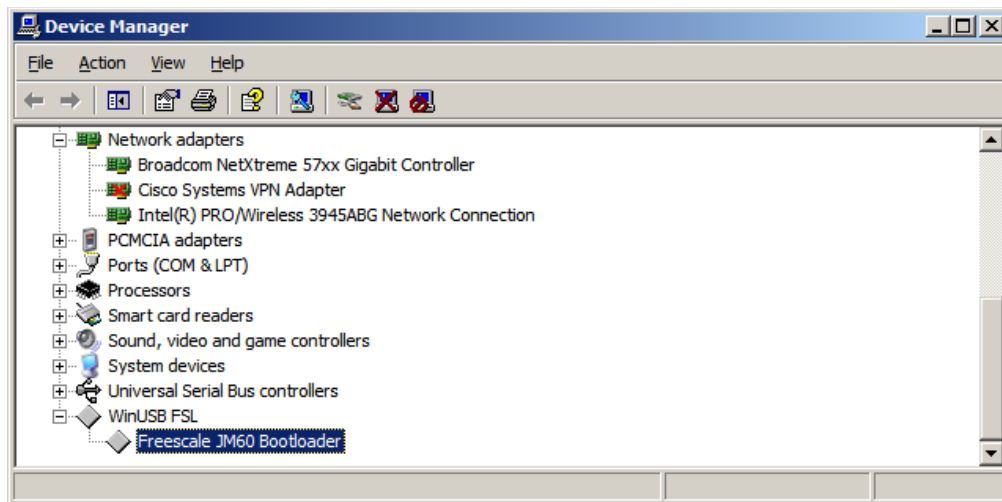

Figure 18. USB Enumeration Succeed

### 3.3.2 Erase Flash

Click the Erase button to erase the flash memory with the addresses 0x1960 to FBFF. If it succeeds, OK appears beside the Erase button as shown in Figure 19. Please erase the flash memory before programming.

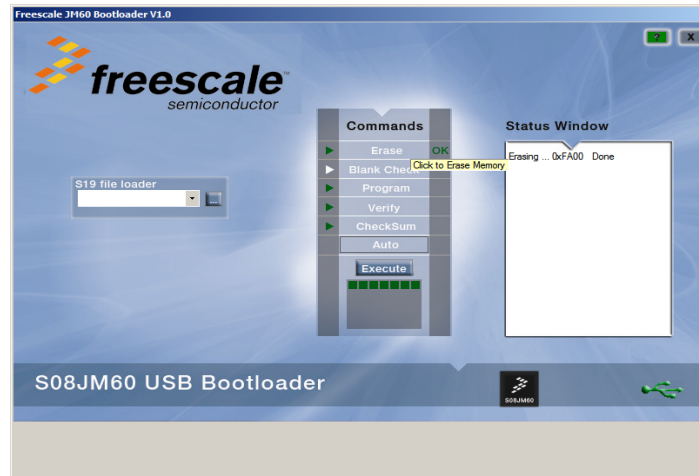

Figure 19. Erase Flash

### 3.3.3 Programming Flash

Click the button on the right side of the S19 file loader to select the .s19 file to be programmed. Only the S-record file is supported by this GUI.

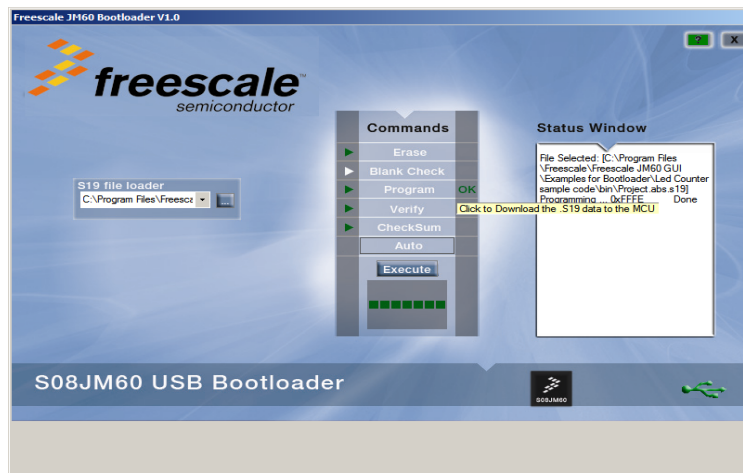

Figure 20. Flash Programming

Click the Program button to program the flash memory. Only the flash address from 0x1960 to 0xFBFF is programmed, out of this range it is ignored. If it succeeds, OK appears beside the program command as shown in Figure 20.



## Conclusion

If you fail to program the flash memory, check the following items:

- The S-record file loaded is correctly
- Flash memory is blank before programming
- Flash memory clock setting is correct
- Flash is not secured or protected
- COP is disabled

### 3.3.4 Code Verification

The bootloader can verify the code in the MCU after it is programmed. Click the Verify button for verification. If the code is programmed correctly, verification succeeds as shown in [Figure 21](#).

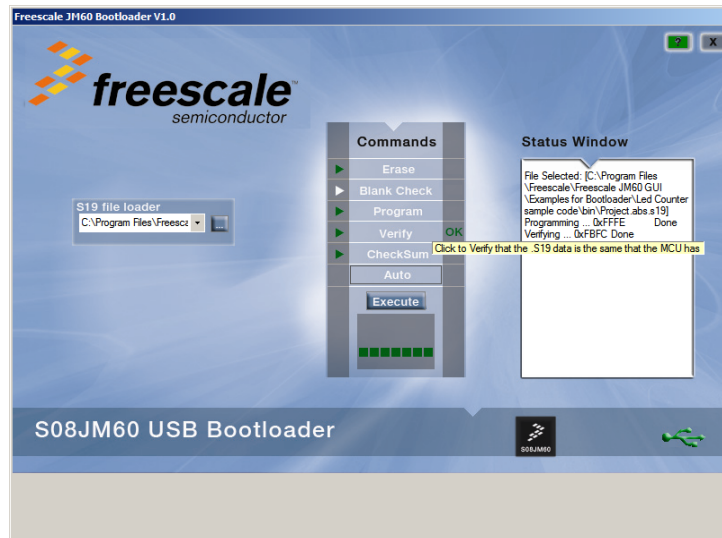

Figure 21. Code Verification

## 4 Conclusion

This application note has covered the following topics:

- Background information — Introduces what the USB bootloader is and its benefits.
- Bootloader overview — The bootloader startup process, initialization, and PC GUI tool are explained.
- Tutorial for bootloader implementation — Step by step instructions on how to use bootloader.
- An example project.



## Appendix A Example Project

An example project is provided for reference. This project is based on the MC9S08JM60 demonstration board and CodeWarrior for the HC(S)08 V5.1 with the MC9S08JM60 service pack.

Demonstration procedure is:

1. Download the project into the MC9S08JM60 demonstration board
2. Power on the board with the PTG0 button pressed to enter bootloader mode
3. After the driver is finished installing, it is ready for use

Please find the project in the *AN3561SW* for this application note.

**How to Reach Us:****Home Page:**

[www.freescale.com](http://www.freescale.com)

**Web Support:**

<http://www.freescale.com/support>

**USA/Europe or Locations Not Listed:**

Freescale Semiconductor, Inc.  
Technical Information Center, EL516  
2100 East Elliot Road  
Tempe, Arizona 85284  
+1-800-521-6274 or +1-480-768-2130  
[www.freescale.com/support](http://www.freescale.com/support)

**Europe, Middle East, and Africa:**

Freescale Halbleiter Deutschland GmbH  
Technical Information Center  
Schatzbogen 7  
81829 Muenchen, Germany  
+44 1296 380 456 (English)  
+46 8 52200080 (English)  
+49 89 92103 559 (German)  
+33 1 69 35 48 48 (French)  
[www.freescale.com/support](http://www.freescale.com/support)

**Japan:**

Freescale Semiconductor Japan Ltd.  
Headquarters  
ARCO Tower 15F  
1-8-1, Shimo-Meguro, Meguro-ku,  
Tokyo 153-0064  
Japan  
0120 191014 or +81 3 5437 9125  
[support.japan@freescale.com](mailto:support.japan@freescale.com)

**Asia/Pacific:**

Freescale Semiconductor Hong Kong Ltd.  
Technical Information Center  
2 Dai King Street  
Tai Po Industrial Estate  
Tai Po, N.T., Hong Kong  
+800 2666 8080  
[support.asia@freescale.com](mailto:support.asia@freescale.com)

**For Literature Requests Only:**

Freescale Semiconductor Literature Distribution Center  
P.O. Box 5405  
Denver, Colorado 80217  
1-800-441-2447 or 303-675-2140  
Fax: 303-675-2150  
[LDCForFreescaleSemiconductor@hibbertgroup.com](mailto:LDCForFreescaleSemiconductor@hibbertgroup.com)

Document Number: AN3561  
Rev. 1  
05/2008

Information in this document is provided solely to enable system and software implementers to use Freescale Semiconductor products. There are no express or implied copyright licenses granted hereunder to design or fabricate any integrated circuits or integrated circuits based on the information in this document.

Freescale Semiconductor reserves the right to make changes without further notice to any products herein. Freescale Semiconductor makes no warranty, representation or guarantee regarding the suitability of its products for any particular purpose, nor does Freescale Semiconductor assume any liability arising out of the application or use of any product or circuit, and specifically disclaims any and all liability, including without limitation consequential or incidental damages. "Typical" parameters that may be provided in Freescale Semiconductor data sheets and/or specifications can and do vary in different applications and actual performance may vary over time. All operating parameters, including "Typicals", must be validated for each customer application by customer's technical experts. Freescale Semiconductor does not convey any license under its patent rights nor the rights of others. Freescale Semiconductor products are not designed, intended, or authorized for use as components in systems intended for surgical implant into the body, or other applications intended to support or sustain life, or for any other application in which the failure of the Freescale Semiconductor product could create a situation where personal injury or death may occur. Should Buyer purchase or use Freescale Semiconductor products for any such unintended or unauthorized application, Buyer shall indemnify and hold Freescale Semiconductor and its officers, employees, subsidiaries, affiliates, and distributors harmless against all claims, costs, damages, and expenses, and reasonable attorney fees arising out of, directly or indirectly, any claim of personal injury or death associated with such unintended or unauthorized use, even if such claim alleges that Freescale Semiconductor was negligent regarding the design or manufacture of the part.

RoHS-compliant and/or Pb-free versions of Freescale products have the functionality and electrical characteristics as their non-RoHS-compliant and/or non-Pb-free counterparts. For further information, see <http://www.freescale.com> or contact your Freescale sales representative.

For information on Freescale's Environmental Products program, go to <http://www.freescale.com/epp>.

Freescale™ and the Freescale logo are trademarks of Freescale Semiconductor, Inc. All other product or service names are the property of their respective owners.  
© Freescale Semiconductor, Inc. 2008. All rights reserved.