



PHILIPS

Philips Semiconductors

800MHz PA Driver with BFG21W

800MHz PA Driver with BFG21W

Application Note
JL-9803v2

Author

Jarek Lucek

November 8, 1998

Discrete Semiconductors - Mansfield
171 Forbes Blvd.
Mansfield, MA 02048

Abstract

BFG21W, the new 5th generation transistor from Philips Semiconductors, is well suited for PA driver applications in AMPS, TDMA, CDMA and GSM systems. BFG21W's performance is superior at 800MHz, 3.0V applications. Under CW mode, the part is capable of P_{1dB}=25dBm, efficiency of 70% and G_p of 17dB. BFG21W delivers 23dBm of linear output power under TDMA with G_p of 18dB and efficiency of over 50%. Under CDMA mode, BFG21W delivers 19dBm of linear output power with G_p of 19 dB and efficiency of 35%.



INTRODUCTION

BFG21W is Philips Semiconductors' 5th generation silicon bipolar RF wideband transistor in SOT343R plastic SMD package. The transistor delivers superior performance at frequencies below 3 GHz. It is manufactured according to the *double poly* process and characterised by high transition frequency ($f_T > 20$ GHz) at low sub 3 Volt supply voltages. This application notes describes BFG21W performance at 800MHz operation under CW, 2 Tone, TDMA and CDMA conditions.

PERFORMANCE OVERVIEW

The table below summarises BFG21W performance capabilities under different modes of operation.

System	Vsupply	P1dB or Plinear* dBm		Gain** dB		Efficiency*** %	
		Icq=10mA	Icq=20mA	Icq=10mA	Icq=20mA	Icq=10mA	Icq=20mA
CW	3.0 Volts	24	24.5	18	18.2	66	68
	3.5 Volts	24.5	25	18.8	19	60	63
2Tone	3.0 Volts	19	19	19	19.5	43	41
	3.5 Volts	20.5	20.5	19.5	19.9	43	40
TDMA	3.0 Volts	21	23	18.9	18.2	48	60
	3.5 Volts	23	24	19.4	18.8	52	57
CDMA	3.0 Volts	17	19	18.8	19	33	39
	3.5 Volts	19.5	20	19.2	19.5	35	38

Table 1: BFG21W 800MHz PA driver performance summary

- * - CW - load power @ P1dB
2Tone - load power represents linear average power @ IMD levels reaching -28dBc.
TDMA - load power represents linear average power @ ACPR levels reaching -26dBc or ALT levels reaching -45dBc.
CDMA load power represents linear average power @ ACPR levels reaching -44dBc with 885kHz channel offset or -56dBc with 1.98MHz channel offset, 1.25MHz channel bandwidth and 30KHz Adjacent Channel bandwidth
- ** - typical Gain at P1dB for CW or Plinear for 2Tone, TDMA, CDMA signals
- *** - typical Efficiency at P1dB for CW or Plinear for 2Tone, TDMA, CDMA signals.



CIRCUIT DESCRIPTION

Figure 1 shows circuit diagram of 800MHz PA driver with BFG21W. Appendix 1 includes the part list of the demo board. Red ground represents a common point.

BFG21W, 836MHz demoboard

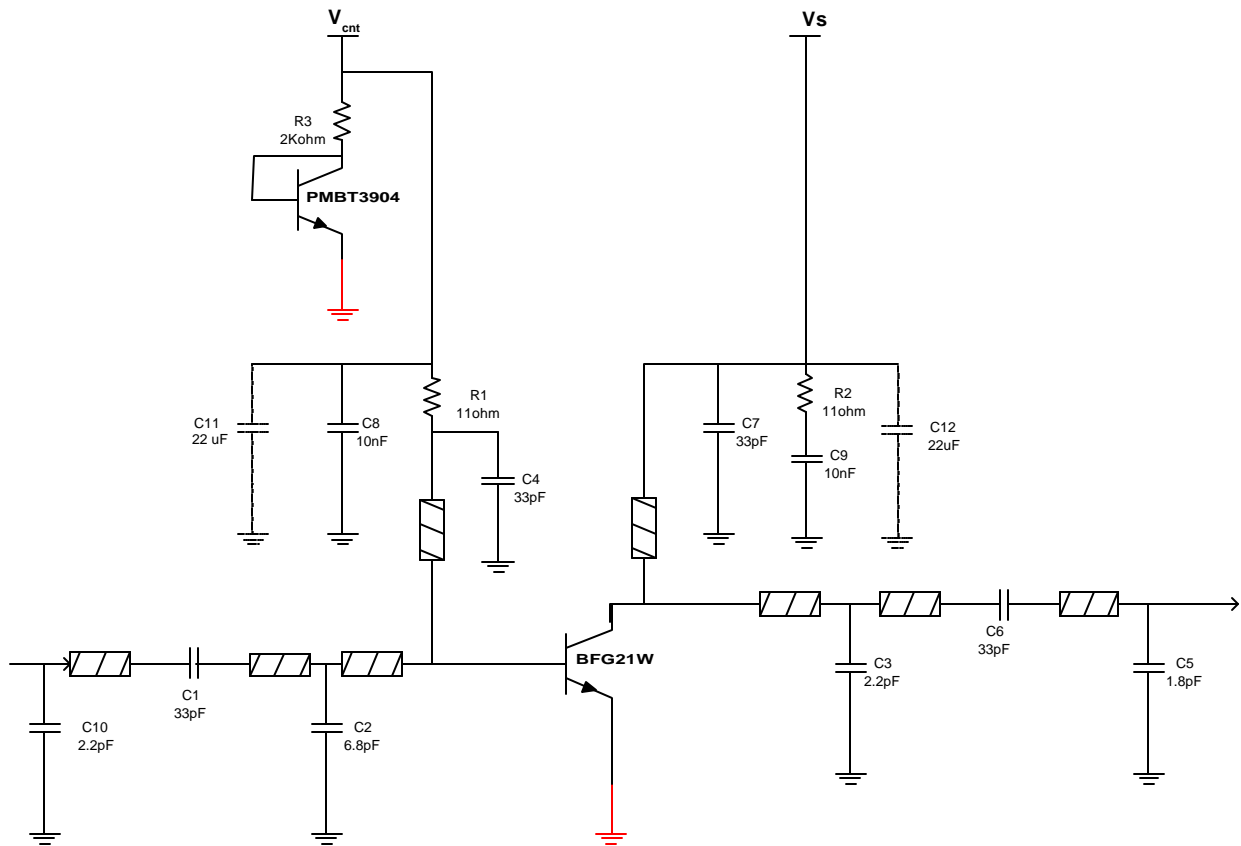

Figure 1: Circuit diagram of the 800MHz PA driver demo board.



BOARD LAYOUT

Figure 3 shows the layout of the PCB, which has the following properties:

type: FR4 bilayer (backside ground)
h = 0.71 mm
t = 35 μm (Cu cladding, not coated)
 $\epsilon_r = 4.6$
 $\tan\delta = 0.02$

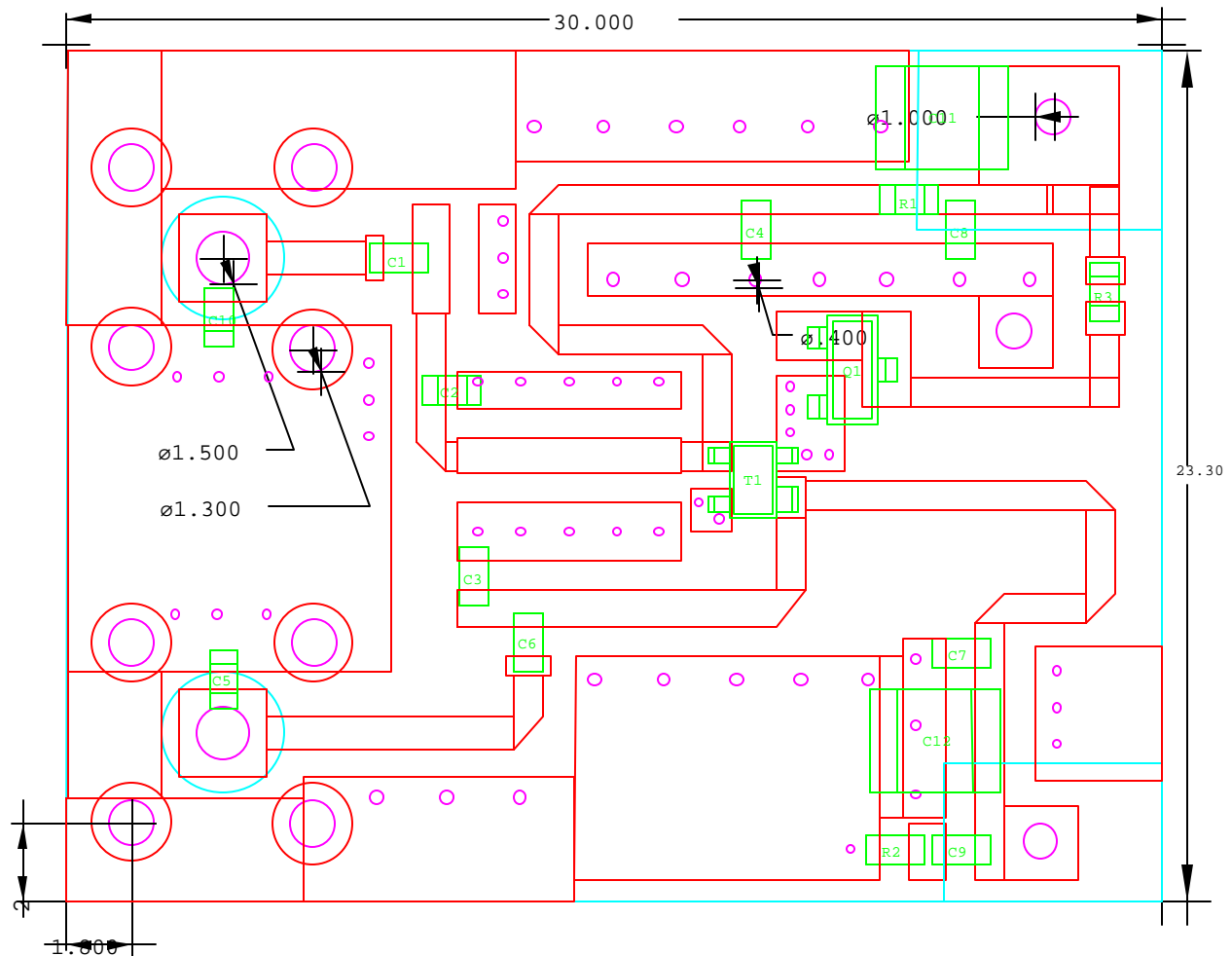

Figure 3: Layout of the 800MHz BFG21W PA driver.

All resistors and capacitors used are Philips 0603 SMD types, with exception of C11 and C12. **C11 and C12, used for 2Tone and CDMA performance enhancement, are tantalum types.** Appendix 1 contains the part list of the demo board. The position of components C2, C3, C5 and C10 is critical. Appendix 2 contains Spice model for BFG21W.



PERFORMANCE

BFG21W was evaluated under 4 different modes of operation. Each mode of operation is summarised below. All measurements were taken with 100% duty cycle signal.

CW

BFG21W under CW at 836 MHz and 25 deg. C

Vc=3.5V, Icq=1mA, Vcnt=0.74V

Pin dBm	Pout dBm	Pout mWatt	Gain dB	It mA	Eff %
-6.96	5	3.16	11.96	11.01	8.21
-4.29	10	10.00	14.29	20.64	13.84
-1.38	15	31.62	16.38	38.89	23.23
2.05	20	100.00	17.95	73.36	38.95
3.52	22	158.49	18.48	93.78	48.29
5.97	24	251.19	18.03	123	58.35
7.4	25	316.23	17.6	140	64.54
9.36	26	398.11	16.64	162.52	69.99
13.04	27	501.19	13.96	200.26	71.51

Vc=3V, Icq=1mA, Vcnt=0.74V

Pin dBm	Pout dBm	Pout mWatt	Gain dB	It mA	Eff %
-6.73	5	3.16	11.73	11.12	9.48
-4.09	10	10.00	14.09	20.9	15.95
-1.29	15	31.62	16.29	39.25	26.86
2.53	20	100.00	17.47	73.74	45.20
4.34	22	158.49	17.66	96.22	54.91
6.86	24	251.19	17.14	124.92	67.03
8.97	25	316.23	16.03	146.04	72.18
12.95	26	398.11	13.05	183.8	72.20
14.24	26.27	423.64	12.03	198.6	71.10

Vc=3.5V, Icq=5mA, Vcnt=0.78V

Pin dBm	Pout dBm	Pout mWatt	Gain dB	It mA	Eff %
-11.34	5	3.16	16.34	13.51	6.69
-7.28	10	10.00	17.28	23.2	12.32
-3.29	15	31.62	18.29	41.56	21.74
0.81	20	100.00	19.19	75.69	37.75
2.56	22	158.49	19.44	96.2	47.07
5.3	24	251.19	18.7	124.5	57.65
6.82	25	316.23	18.18	141.72	63.75
8.88	26	398.11	17.12	163.55	69.55
12.72	27	501.19	14.28	201.86	70.94

Vc=3V, Icq=5mA, Vcnt=0.80V

Pin dBm	Pout dBm	Pout mWatt	Gain dB	It mA	Eff %
-10.93	5	3.16	15.93	13.43	7.85
-6.86	10	10.00	16.86	23.11	14.42
-2.88	15	31.62	17.88	41.53	25.38
1.33	20	100.00	18.67	76	43.86
3.37	22	158.49	18.63	97.41	54.23
6.28	24	251.19	17.72	127.71	65.56
8.56	25	316.23	16.44	146.9	71.76
12.9	26	398.11	13.1	187.4	70.81
14.14	26.32	428.55	12.18	201.68	70.83

Vc=3.5V, Icq=10mA, Vcnt=0.79V

Pin dBm	Pout dBm	Pout mWatt	Gain dB	It mA	Eff %
-12.86	5	3.16	17.86	16.14	5.60
-8.28	10	10.00	18.28	25.23	11.32
-3.96	15	31.62	18.96	43.38	20.83
0.59	20	100.00	19.41	76.51	37.34
2.34	22	158.49	19.66	98.69	45.88
5.13	24	251.19	18.87	126.1	56.91
6.53	25	316.23	18.47	141.68	63.77
8.67	26	398.11	17.33	163.57	69.54
12.43	27	501.19	14.57	200.9	71.28

Vc=3V, Icq=10mA, Vcnt=0.80V

Pin dBm	Pout dBm	Pout mWatt	Gain dB	It mA	Eff %
-12.98	5	3.16	17.98	16.29	6.47
-8.23	10	10.00	18.23	25.31	13.17
-3.81	15	31.62	18.81	43.2	24.40
1.1	20	100.00	18.9	77.12	43.22
3.09	22	158.49	18.91	98.59	53.59
5.99	24	251.19	18.01	126.83	66.02
8.37	25	316.23	16.63	148.15	71.15
12.4	26	398.11	13.6	184.41	71.96
13.95	26.31	427.56	12.36	201.8	70.62

Vc=3.5V, Icq=20mA, Vcnt=0.80V

Pin dBm	Pout dBm	Pout mWatt	Gain dB	It mA	Eff %
-14.61	5	3.16	19.61	24.52	3.68
-9.57	10	10.00	19.57	31.25	9.14
-4.88	15	31.62	19.88	47.13	19.17
0.3	20	100.00	19.7	78.74	36.29
2	22	158.49	20	100	45.28
4.83	24	251.19	19.17	127.55	56.27
6.33	25	316.23	18.67	143.54	62.94
8.38	26	398.11	17.62	164.52	69.14
11.87	27	501.19	15.13	198.5	72.14

Vc=3V, Icq=20mA, Vcnt=0.81V

Pin dBm	Pout dBm	Pout mWatt	Gain dB	It mA	Eff %
-14.53	5	3.16	19.53	23.22	4.54
-9.3	10	10.00	19.3	29.61	11.26
-4.55	15	31.62	19.55	45.34	23.25
0.79	20	100.00	19.21	78.5	42.46
2.94	22	158.49	19.06	99.44	53.13
5.74	24	251.19	18.26	127.36	65.74
8.27	25	316.23	16.73	149.37	70.57
12.26	26	398.11	13.74	185.32	71.61
14.14	26.36	432.51	12.22	206.22	69.91

It=Ic+Ib, total current draw.



CW

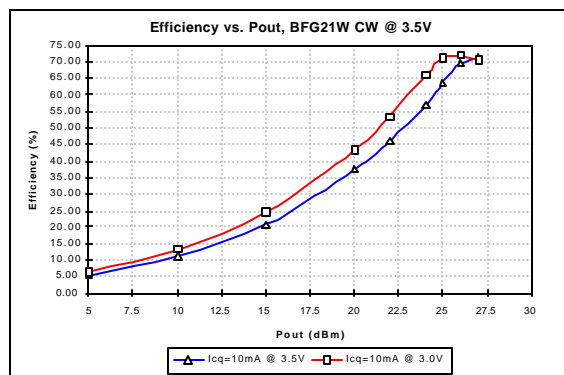
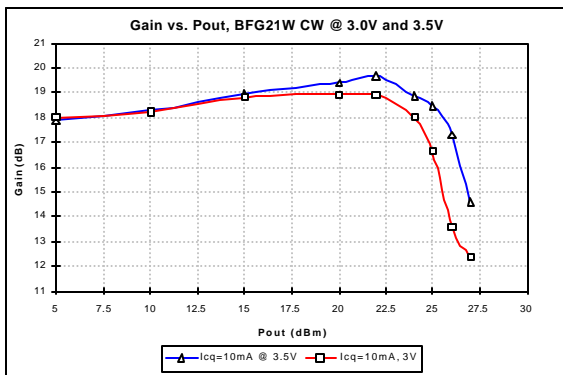
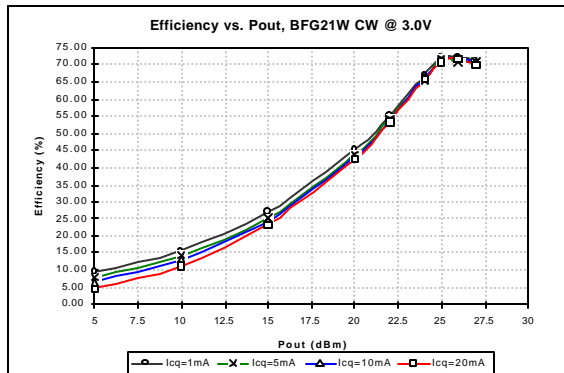
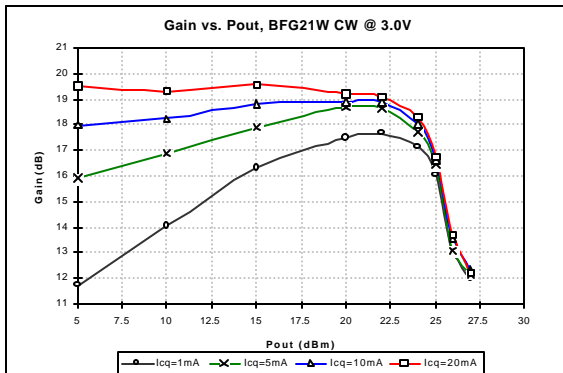
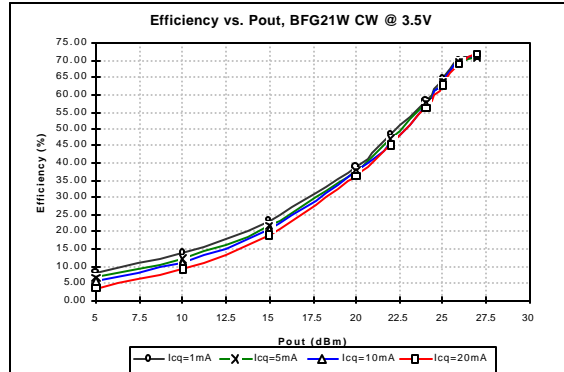
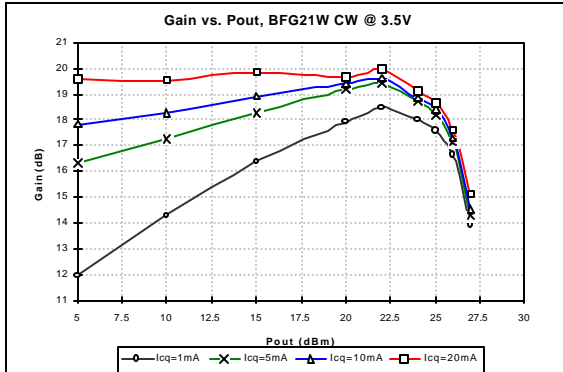



2 TONE

BFG21W under 2tone at 836 MHz and 25 deg. C

Vc=3.5V, Icq=10mA, Vcnt=0.79V

Pin dBm	Pout dBm	Pout mWatt	Gain dB	3rd low dBc	3rd high dBc	5th low dBc	5th high dBc	It mA	Eff %
-13.2	5	3.16	18.2	-43	-43	-57	-57	16.3	5.54
-8.6	10	10.00	18.6	-38	-38	-52	-52	25	11.43
-4.4	15	31.62	19.4	-37	-37	-48	-48	41	22.04
-2.4	17	50.12	19.4	-37	-37	-47	-47	51	28.08
-0.5	19	79.43	19.5	-37	-36	43	-43	63	36.02
0.55	20	100.00	19.45	-34	-33	-40	-40	71	40.24
1.65	21	125.89	19.35	-29	-29	-37	-37	79	45.53
4.2	23	199.53	18.8	-21	-20	-38	-37	101	56.44

Vc=3.5V, Icq=20mA, Vcnt=0.79V

Pin dBm	Pout dBm	Pout mWatt	Gain dB	3rd low dBc	3rd high dBc	5th low dBc	5th high dBc	It mA	Eff %
-14.8	5	3.16	19.8	-49	-48.5	-59	-59	25	3.61
-9.6	10	10.00	19.6	-43	-42	-60	-59	31.6	9.04
-5	15	31.62	20	-41	-40	-50	-50	47	19.22
-3.1	17	50.12	20.1	-43	-43	-47	-47	56	25.57
-0.95	19	79.43	19.95	-46	-45	-44	-43	67	33.87
0.1	20	100.00	19.9	-35	-35	-41	-41	74	38.61
1.22	21	125.89	19.78	-29	-29	-39	-39	83	43.34
4	23	199.53	19	-21	-21	-41	-40	103	55.35

Vc=3.0V, Icq=10mA, Vcnt=0.78V

Pin dBm	Pout dBm	Pout mWatt	Gain dB	3rd low dBc	3rd high dBc	5th low dBc	5th high dBc	It mA	Eff %
-12.8	5	3.16	17.8	-40	-40	-56	-55	16	6.59
-8.3	10	10.00	18.3	-35	-35	-52	-52	23.6	14.12
-4.12	15	31.62	19.12	-34	-34	-47	-47	40	26.35
-2.2	17	50.12	19.2	-33	-32	43	-43	49	34.09
0	19	79.43	19	-30	-30	-37	-37	62	42.71
1.1	20	100.00	18.9	-27	-26	-35	-35	69	48.31
2.4	21	125.89	18.6	-23	-23	35	-34	79	53.12
5.6	23	199.53	17.4	-15	-16	-30	-30	103	64.57

Vc=3.0V, Icq=20mA, Vcnt=0.81V

Pin dBm	Pout dBm	Pout mWatt	Gain dB	3rd low dBc	3rd high dBc	5th low dBc	5th high dBc	It mA	Eff %
-14.55	5	3.16	19.55	-50	-49	-59	-58	24	4.39
-9.46	10	10.00	19.46	-43	-43	-59	-59	30	11.11
-4.8	15	31.62	19.8	-45	-45	-48	-48	44	23.96
-2.6	17	50.12	19.6	-55	-55	-46	-46	54	30.94
-0.5	19	79.43	19.5	-34	-34	-40	-40	65	40.73
0.8	20	100.00	19.2	-28	-28	-38	-38	74	45.05
2.03	21	125.89	18.97	-24	-23	-39	-39	82	51.18
5.3	23	199.53	17.7	-16	-16	-33	-32	105	63.34

It=Ic+Ib, total current draw.



2 TONE

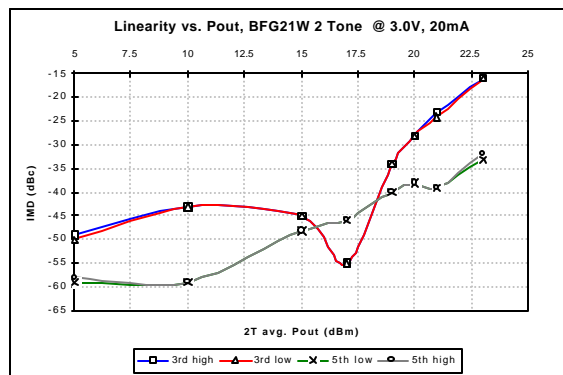
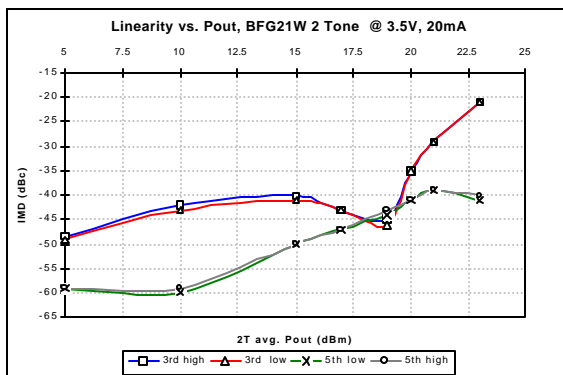
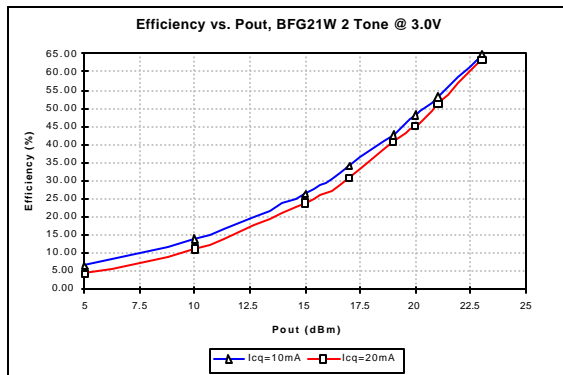
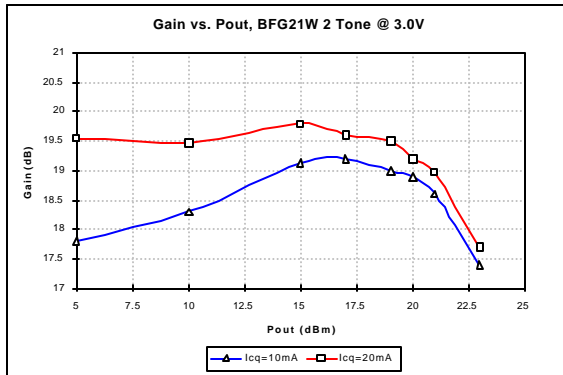
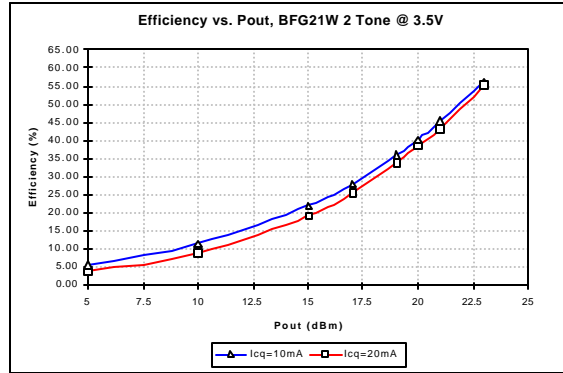
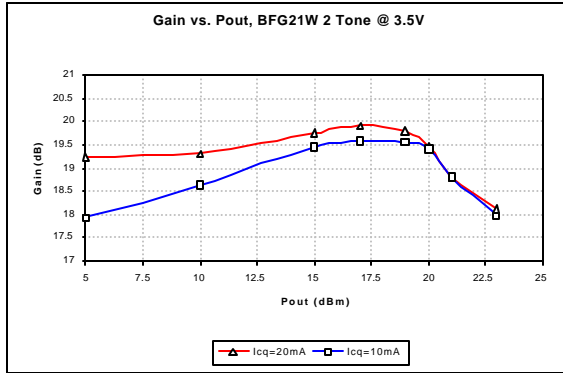



TDMA

BFG21W under TDMA at 836 MHz and 25 deg. C

Vc=3.5V, Icq=10mA, Vcnt=0.79V

Pin dBm	Pout dBm	Pout mWatt	Gain dB	ACPR low dB	ACPR high dB	1st ALT low dB	1st ALT high dB	2nd ALT low dB	2nd ALT high dB	It mA	Eff %
-12.93	5	3.16	17.93	-36.8	-36	-70.5	-70.1	-66.9	-66	17.4	5.19
-8.63	10	10.00	18.63	-36.1	-33.4	-64.8	-66.2	-68.2	-67.9	25	11.43
-4.44	15	31.62	19.44	-37.3	-37.1	-59.5	-60.9	-70	-70	42.88	21.07
0.43	20	100.00	19.57	-35.5	-36.9	-55.9	-56.9	-68.2	-68.4	75.75	37.72
2.45	22	158.49	19.55	-32.3	-31.9	-51.2	-51.9	-65.2	-65.6	97.8	46.30
3.6	23	199.53	19.4	-29.3	-29.3	-50.8	-51.5	-60.4	-60.7	108.43	52.58
5.21	24	251.19	18.79	-26	-25.3	-50.3	-50.9	-57.3	-58.1	124.48	57.65
7.04	25	316.23	17.96	-22.9	-23	-45.8	-45.8	-56.3	-56.9	141.98	63.64

Vc=3.5V, Icq=20mA, Vcnt=0.79V

Pin dBm	Pout dBm	Pout mWatt	Gain dB	ACPR low dB	ACPR high dB	1st ALT low dB	1st ALT high dB	2nd ALT low dB	2nd ALT high dB	It mA	Eff %
-14.22	5	3.16	19.22	-35.1	-35.6	-53.6	-54.7	-63.2	-65.8	22.42	4.03
-9.3	10	10.00	19.3	-36.8	-35.4	-54.4	-54.2	-61.9	-63	29.6	9.65
-4.75	15	31.62	19.75	-35.2	-36.6	-60.3	-61.7	-70.5	-70.9	46.34	19.50
0.08	20	100.00	19.92	-35.5	-34.3	-55.1	-56.3	-69.6	-68.7	77.9	36.68
2.22	22	158.49	19.78	-32.1	-31.6	-50.9	-51.4	-64.5	-65.1	98.6	45.93
3.54	23	199.53	19.46	-28.1	-28.7	-49.9	-50.3	-60.1	-59.5	111	51.36
5.2	24	251.19	18.8	-26.9	-26.7	-53.4	-53.9	-58.8	-59.3	125.6	57.14
6.88	25	316.23	18.12	-23.2	-23.9	-46.8	-47	-57.8	-58.2	142.9	63.23

Vc=3.0V, Icq=10mA, Vcnt=0.78V

Pin dBm	Pout dBm	Pout mWatt	Gain dB	ACPR low dB	ACPR high dB	1st ALT low dB	1st ALT high dB	2nd ALT low dB	2nd ALT high dB	It mA	Eff %
-12.85	5	3.16	17.85	-35.7	-37.8	-68.9	-68.8	-65.5	-66.2	16	6.59
-8.16	10	10.00	18.16	-36.8	-36.3	-63.8	-64.1	-67.5	-67.4	25	13.33
-4.01	15	31.62	19.01	-36.4	-35.3	-59.9	-62	-69.2	-69.5	42.57	24.76
0.93	20	100.00	19.07	-34	-33.6	-51.2	-52.2	-68.6	-69.5	75.34	44.24
3.54	22	158.49	18.46	-28.1	-28	-48.6	-48.9	-59.7	-59.5	97.5	54.18
5.14	23	199.53	17.86	-25.3	-24.8	-48.7	-48.1	-56.7	-57.5	111	59.92
7.13	24	251.19	16.87	-21.5	-21.4	-40.6	-40.1	-54.6	-54.9	129.3	64.76
10.06	25	316.23	14.94	-19.9	-19.4	-34.6	-34	-48.2	-47.8	155.3	67.87

Vc=3.0V, Icq=20mA, Vcnt=0.81V

Pin dBm	Pout dBm	Pout mWatt	Gain dB	ACPR low dB	ACPR high dB	1st ALT low dB	1st ALT high dB	2nd ALT low dB	2nd ALT high dB	It mA	Eff %
-13.79	5	3.16	18.79	-36.2	-36.1	-53	-53.1	-60.5	-61.8	19.13	5.51
-8.87	10	10.00	18.87	-37.3	-36.5	-64.9	-65.5	-68.5	-68.8	26.89	12.40
-4.26	15	31.62	19.26	-37	-37	-59.8	-60.4	-69.9	-70.1	44.14	23.88
0.65	20	100.00	19.35	-34.5	-34.1	-52	-53	-67.4	-67.9	76.46	43.60
3.2	22	158.49	18.8	-29.4	-28.8	-50.6	-50.6	-60.1	-60	97.56	54.15
4.81	23	199.53	18.19	-26.1	-25.9	-51.1	-51.5	-58.4	-58.7	111.56	59.62
6.82	24	251.19	17.18	-22.9	-22.4	-43.2	-42.2	-57.2	-57.3	129.42	64.70
9.67	25	316.23	15.33	-20	-20	-34.7	-34.6	-50.7	-49.8	153.52	68.66

It=Ic+Ib, total current draw.



TDMA

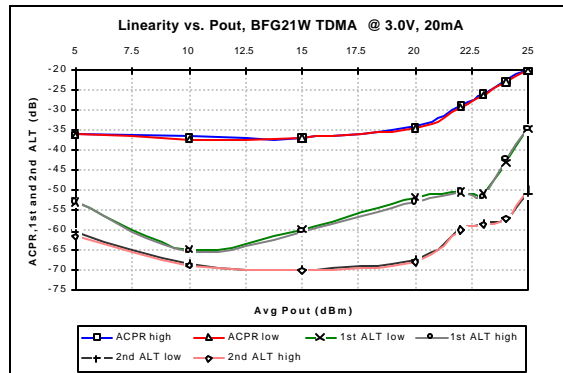
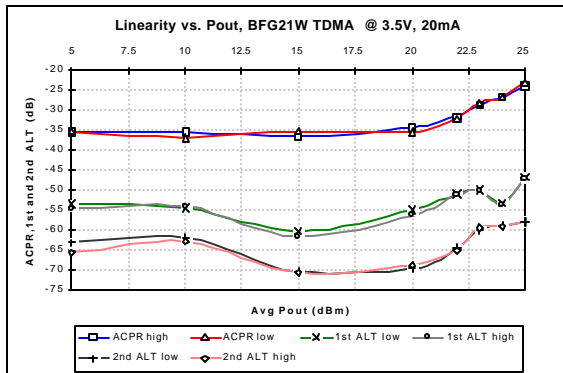
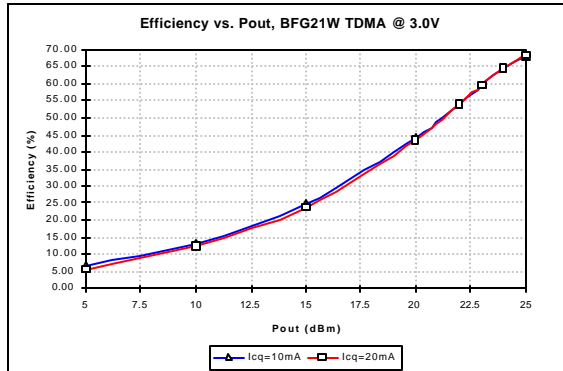
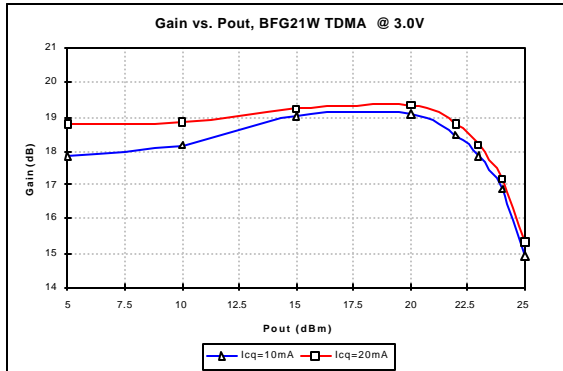
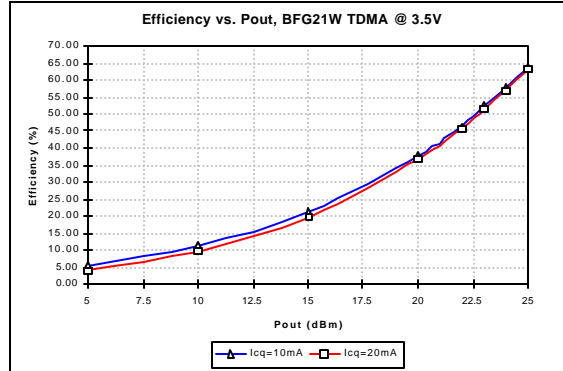
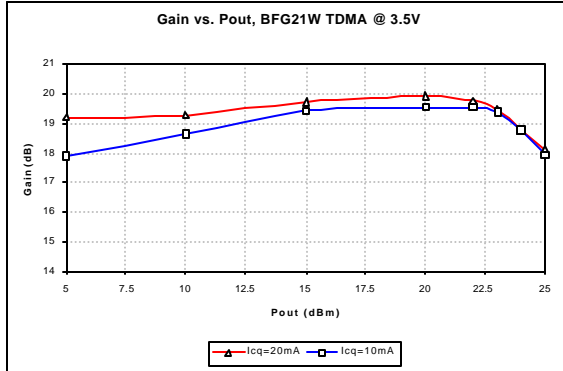



CDMA

BFG21W under CDMA at 836 MHz and 25 deg. C

Vc=3.5V, Icq=10mA, Vcnt=0.79V

Pin dBm	Pout dBm	Pout mWatt	Gain dB	ACPR low dB	ACPR high dB	1st ALT low dB	1st ALT high dB	It mA	Eff %
-13.14	5	3.16	18.14	-59.83	-60.35	-71.23	-71.24	16.3	5.54
-8.36	10	10.00	18.36	-54.86	-55.19	-72.27	-72.51	25	11.43
-4.04	15	31.62	19.04	-54.19	-54.44	-70.22	-70.75	42	21.51
-1.2	18	63.10	19.2	-53.5	-53.5	-64.9	-65.5	58	31.08
-0.23	19	79.43	19.23	-50.6	-51.2	-61.4	-61.8	65.5	34.65
0.75	20	100.00	19.25	-45.69	-46.05	-59.32	-59.29	74.5	38.35
3.1	22	158.49	18.9	-37.6	-38	-57	-58	95	47.67

Vc=3.5V, Icq=20mA, Vcnt=0.79V

Pin dBm	Pout dBm	Pout mWatt	Gain dB	ACPR low dB	ACPR high dB	1st ALT low dB	1st ALT high dB	It mA	Eff %
-14.53	5	3.16	19.53	-65.81	-65.42	-72.42	-72.42	23.41	3.86
-9.36	10	10.00	19.36	-60.63	-60.46	-74.97	-74.97	30.25	9.45
-4.95	15	31.62	19.95	-62.19	-61.29	-70.81	-70.92	45.6	19.81
-1.5	18	63.10	19.5	-61	-61.2	-66.2	-66.4	61	29.55
-0.5	19	79.43	19.5	-53.6	-54.2	-63.5	-66.7	68	33.38
0.45	20	100.00	19.55	-46.23	-46.25	-60.71	-60.29	76.14	37.52
2.94	22	158.49	19.06	-38.3	-38.4	-61	-62	96	47.17

Vc=3.0V, Icq=10mA, Vcnt=0.78V

Pin dBm	Pout dBm	Pout mWatt	Gain dB	ACPR low dB	ACPR high dB	1st ALT low dB	1st ALT high dB	It mA	Eff %
-12.46	5	3.16	17.46	-57.69	-57.99	-71.3	-71.3	15.6	6.76
-8.19	10	10.00	18.19	-52.7	-53.19	-72.76	-72.72	24	13.89
-3.98	15	31.62	18.98	-50	-50.87	-67.84	-67.79	41	25.71
-0.65	18	63.10	18.65	-47.2	-47.7	-58.9	-58.9	57.7	36.45
0.45	19	79.43	18.55	-43.8	-44.3	-57	-57.1	66	40.12
1.23	20	100.00	18.77	-39.18	-39.23	-56.1	-56.15	73.9	45.11
4.54	22	158.49	17.46	-33.3	-33.1	-49.4	-49.3	97.3	54.30

Vc=3.0V, Icq=20mA, Vcnt=0.81V

Pin dBm	Pout dBm	Pout mWatt	Gain dB	ACPR low dB	ACPR high dB	1st ALT low dB	1st ALT high dB	It mA	Eff %
-13.9	5	3.16	18.9	-64.91	-64.57	-71.62	-71.62	20.39	5.17
-9.11	10	10.00	19.11	-61.73	-61.53	-73.2	-73.21	27.7	12.03
-4.19	15	31.62	19.19	-65.3	-64.6	-64.7	-64.49	43.44	24.27
-1.1	18	63.10	19.1	-51.1	-51.5	-62.2	-62.5	60.5	34.76
0	19	79.43	19	-45.8	-46.3	-60.2	-60.6	67	39.52
1.06	20	100.00	18.94	-39.99	-39.9	-58.79	-58.56	75.47	44.17
4.28	22	158.49	17.72	-33.5	-33.5	-50.7	-50.8	98	53.91

It=Ic+Ib, total current draw.



CDMA

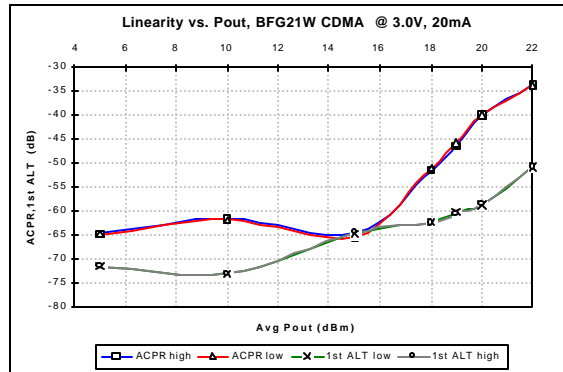
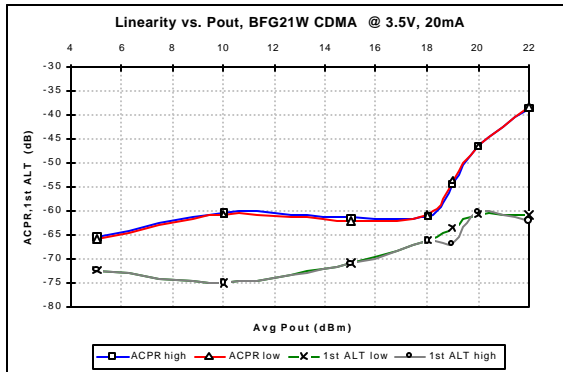
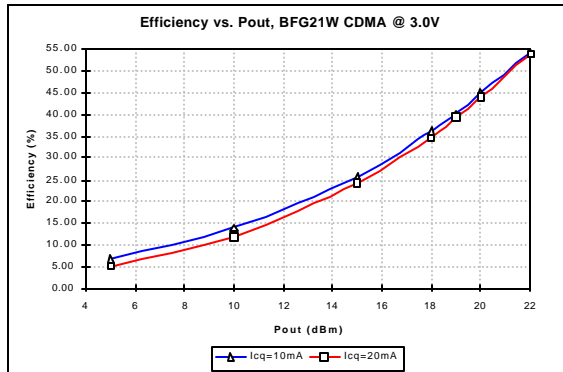
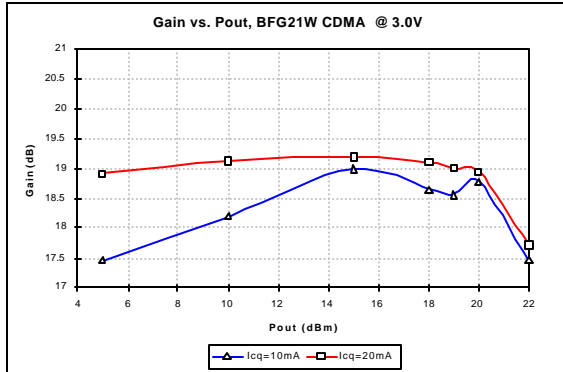
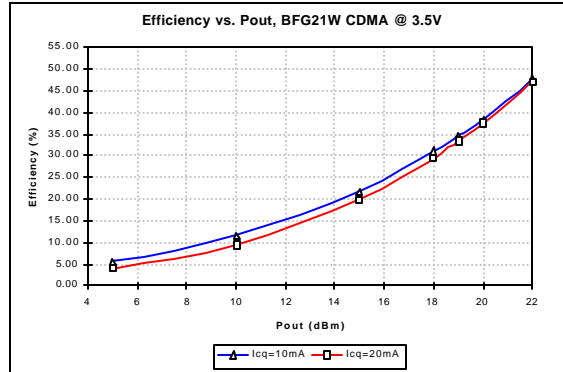
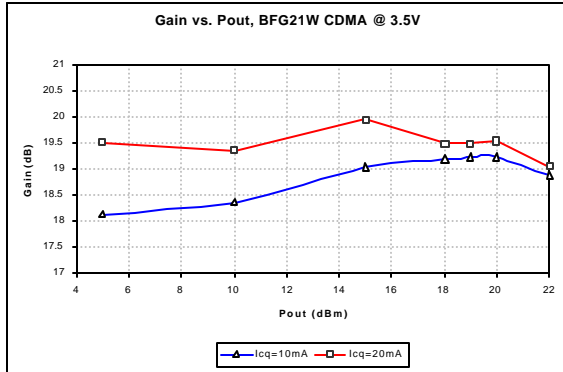



APPENDIX 1: Part list for BFG21W 800MHz PA driver

Resistors

R1	11 Ω	Philips 0805, 0.1W metal film resistor.
R2	11 Ω	Philips 0805, 0.1W metal film resistor.
R3	2 K Ω	Philips 0805, 0.1W metal film resistor.

Capacitors

C1, C6	33 pF	Philips 0603, DC blocking capacitor
C2	6.8 pF	Philips 0603, IRL matching capacitor
C3	2.2 pF	Philips 0603, output matching capacitor
C4, C7	33 pF	Philips 0603, bias and supply decoupling capacitor
C5	1.8 pF	Philips 0603, output matching capacitor
C8, C9	10 nF	Philips 0603, bias and supply low frequency decoupling capacitor
C10	2.2 pF	Philips 0603, IRL matching capacitor
C11, C12	22 μ F	AVX tantalum, bias and supply low frequency decoupling capacitor

Transistors

T1	BFG21W	RF amplifying transistor.
Q1	PMBT3904	Biasing and thermal tracking small signal transistor.



APPENDIX 2:

Spice parameters of the BFG21W

```
.SUBCKT BFG21W 10 11 12
Lbbond 2 5 7.209E-10
Lblead 5 8 2.251E-10
Lbfoot 8 11 1.1E-10
Cbfoot 8 12 1.17E-13
Lebond 3 6 5.15E-11
Lelead 6 9 6.914E-11
Lefoot 9 12 1.739E-10
Cefoot 9 12 1.95E-13
Lcbond 1 4 5.711E-10
Lclead 4 7 2.251E-10
Lcfoot 7 10 1.1E-10
Ccfoot 7 12 1.17E-13
Cbc 5 4 2E-15
Cbe 5 6 8E-14
Cce 4 6 8E-14
Cbpb 2 14 3.3E-13
Cbpc 1 13 3.47E-13
Cmet 1 3 1.7E-12
Rsub1 14 15 249.2
Rsub2 13 15 464.4
Rmut 3 15 100
  Dio 16 1
+ D1
Rs 15 16 3.5
.MODEL D1 D
+ IS = 4.99E-13
+ N = 1.189

Q1 1 2 3 3 NPN
+ AREA = 1
.MODEL NPN NPN
+ IS = 3.835E-16
+ BF = 92
+ NF = 1
+ VAF = 35
+ IKF = 2.8
+ ISE = 9.005E-13
+ NE = 2.262
+ BR = 8.9
+ NR = 1.009
+ VAR = 2.25
+ IKR = 0.6507
+ ISC = 2.503E-15
+ NC = 1.209
+ RB = 1.492
+ IRB = 0
+ RBM = 0.3202
+ RE = 0.3429
+ RC = 0.8
+ CJE = 3.026E-12
+ VJE = 0.9
+ MJE = 0.2861
+ CJC = 1.041E-12
+ VJC = 0.6964
+ MJC = 0.308
+ CJS = 1.844E-12
+ VJS = 0.4237
+ MJS = 0.2606
+ XCJC = 0.5
+ TR = 1.5E-10
+ TF = 5.05E-12
+ XTF = 74
+ VTF = 0.8
+ ITF = 6.5
+ PTF = 0
+ FC = 0.875
+ EG = 1.11
+ XTI = 4.3
+ XTB = 0.5
.END
```