

# MC9S08FL16

# MC9S08FL8

## Reference Manual

### *HCS08* *Microcontrollers*

#### Related Documentation:

---

- **MC9S08FL16 (Data Sheet)**  
Contains pin assignments and diagrams, all electrical specifications, and mechanical drawing outlines.

Find the most current versions of all documents at:  
<http://www.freescale.com>

MC9S08FL16RM  
Rev. 3  
11/2010

[freescale.com](http://www.freescale.com)



# MC9S08FL16 Features

## 8-Bit S08 Central Processor Unit (CPU)

---

- Up to 20 MHz CPU at 4.5 V to 5.5 V across temperature range  $-40^{\circ}\text{C}$  to  $85^{\circ}\text{C}$
- HC08 instruction set with added BGND instruction
- Support for up to 32 interrupt/reset sources

## On-Chip Memory

---

- Up to 16 KB flash read/program/erase over full operating voltage and temperature
- Up to 1024-byte random-access memory (RAM)
- Security circuitry to prevent unauthorized access to RAM and flash contents

## Power-Saving Modes

---

- Two low power stop modes; reduced power wait mode
- Allowing clocks to remain enabled to specific peripherals in stop3 mode

## Clock Source Options

---

- Oscillator (XOSC) — Loop-control Pierce oscillator; crystal or ceramic resonator range of 31.25 kHz to 39.0625 kHz or 1 MHz to 16 MHz
- Internal Clock Source (ICS) — Internal clock source module containing a frequency-locked-loop (FLL) controlled by internal or external reference; precision trimming of internal reference allows 0.2% resolution and 2% deviation over temperature and voltage; supports bus frequencies up to 10 MHz

## System Protection

---

- Watchdog computer operating properly (COP) reset with option to run from dedicated 1 kHz internal clock source or bus clock
- Low-voltage detection with reset or interrupt; selectable trip points

- Illegal opcode detection with reset
- Illegal address detection with reset
- Flash block protection

## Development Support

---

- Single-wire background debug interface
- Breakpoint capability to allow single breakpoint setting during in-circuit debugging (plus two more breakpoints)
- On-chip in-circuit emulator (ICE) debug module containing two comparators and nine trigger modes

## Peripherals

---

- **IPC** — Interrupt priority controller to provide hardware based nested interrupt
- **ADC** — 12-channel, 8-bit resolution; 2.5  $\mu\text{s}$  conversion time; automatic compare function; 1.7  $\text{mV}/^{\circ}\text{C}$  temperature sensor; internal bandgap reference channel; operation in stop; optional hardware trigger; fully functional from 4.5V to 5.5 V
- **TPM** — One 4-channel and one 2-channel timer/pulse-width modulators (TPM) modules; selectable input capture, output compare, or buffered edge- or center-aligned PWM on each channel
- **MTIM16** — One 16-bit modulo timer with optional prescaler
- **SCI** — One serial communications interface module with optional 13-bit break; LIN extensions

## Input/Output

---

- 30 GPIOs including one input-only pin and one output-only pin

## Package Options

---

- 32-pin LQFP
- 32-pin SDIP



# MC9S08FL16 MCU Series Reference Manual

Covers: MC9S08FL16  
MC9S08FL8

MC9S08FL16  
Rev. 3  
11/2010

## Revision History

To provide the most up-to-date information, the revision of our documents on the World Wide Web will be the most current. Your printed copy may be an earlier revision. To verify you have the latest information available, refer to:

<http://freescale.com>

The following revision history table summarizes changes contained in this document.

Revision Number	Revision Date	Description of Changes
1	3/20/2009	Initial public release.
2	4/27/2009	Reworded <a href="#">Chapter 9, "16-Bit Timer/PWM (S08TPMV3)."</a> Corrected <a href="#">Table 2-1</a> .
3	11/23/2010	Updated <a href="#">Table 5-12</a> .

This product incorporates SuperFlash<sup>®</sup> technology licensed from SST.

Freescale and the Freescale logo are trademarks of Freescale Semiconductor, Inc.  
© Freescale Semiconductor, Inc., 2009. All rights reserved.

# List of Chapters

<b>Chapter 1 Device Overview</b> .....	<b>17</b>
<b>Chapter 2 Pins and Connections</b> .....	<b>21</b>
<b>Chapter 3 Modes of Operation</b> .....	<b>29</b>
<b>Chapter 4 Memory</b> .....	<b>35</b>
<b>Chapter 5 Resets, Interrupts, and System Configuration</b> .....	<b>57</b>
<b>Chapter 6 Parallel Input/Output</b> .....	<b>73</b>
<b>Chapter 7 Central Processor Unit (S08CPUV3)</b> .....	<b>85</b>
<b>Chapter 8 Internal Clock Source (S08ICSV3)</b> .....	<b>105</b>
<b>Chapter 9 16-Bit Timer/PWM (S08TPMV3)</b> .....	<b>119</b>
<b>Chapter 10 Interrupt Priority Controller (S08IPCV1)</b> .....	<b>143</b>
<b>Chapter 11 16-Bit Modulo Timer (S08MTIM16V1)</b> .....	<b>155</b>
<b>Chapter 12 Analog-to-Digital Converter (S08ADC12V1)</b> .....	<b>167</b>
<b>Chapter 13 Serial Communications Interface (S08SCIV4)</b> .....	<b>195</b>
<b>Chapter 14 Development Support</b> .....	<b>215</b>





# Contents

Section Number	Title	Page
<b>Chapter 1</b>		
<b>Device Overview</b>		
1.1	Introduction .....	17
1.2	MCU Block Diagram .....	18
1.3	System Clock Distribution .....	19
<b>Chapter 2</b>		
<b>Pins and Connections</b>		
2.1	Introduction .....	21
2.2	Device Pin Assignment .....	21
2.3	Recommended System Connections .....	22
2.3.1	Power ( $V_{DD}$ , $V_{SS}$ ) .....	23
2.3.2	Oscillator (XTAL, EXTAL) .....	24
2.3.3	RESET and External Interrupt Pin (IRQ) .....	24
2.3.4	Background/Mode Select (BKGD/MS) .....	25
2.3.5	General-Purpose I/O and Peripheral Ports .....	25
<b>Chapter 3</b>		
<b>Modes of Operation</b>		
3.1	Introduction .....	29
3.2	Features .....	29
3.3	Run Mode .....	29
3.4	Active Background Mode .....	29
3.5	Wait Mode .....	30
3.6	Stop Modes .....	31
3.6.1	Stop3 Mode .....	31
3.6.2	Stop2 Mode .....	32
3.6.3	On-Chip Peripheral Modules in Stop Modes .....	32
<b>Chapter 4</b>		
<b>Memory</b>		
4.1	MC9S08FL16 Series Memory Map .....	35
4.1.1	Reset and Interrupt Vector Assignments .....	37
4.2	Register Addresses and Bit Assignments .....	37
4.3	RAM (System RAM) .....	42
4.4	Flash .....	43
4.4.1	Features .....	43
4.4.2	Program and Erase Times .....	43
4.4.3	Program and Erase Command Execution .....	44

4.4.4	Burst Program Execution .....	45
4.4.5	Access Errors .....	47
4.4.6	Flash Block Protection .....	47
4.4.7	Vector Redirection .....	48
4.5	Security .....	48
4.6	Flash Registers and Control Bits .....	49
4.6.1	Flash Clock Divider Register (FCDIV) .....	50
4.6.2	Flash Options Register (FOPT and NVOPT) .....	51
4.6.3	Flash Configuration Register (FCNFG) .....	52
4.6.4	Flash Protection Register (FPROT and NVPROT) .....	53
4.6.5	Flash Status Register (FSTAT) .....	53
4.6.6	Flash Command Register (FCMD) .....	55

## Chapter 5 Resets, Interrupts, and System Configuration

5.1	Introduction .....	57
5.2	Features .....	57
5.3	MCU Reset .....	57
5.4	Computer Operating Properly (COP) Watchdog .....	58
5.5	Interrupts .....	59
5.5.1	Interrupt Stack Frame .....	59
5.5.2	External Interrupt Request (IRQ) Pin .....	60
5.5.3	Interrupt Vectors, Sources, and Local Masks .....	61
5.6	Low-Voltage Detect (LVD) System .....	62
5.6.1	Power-On Reset Operation .....	63
5.6.2	LVD Reset Operation .....	63
5.6.3	Low-Voltage Warning (LVW) Interrupt Operation .....	63
5.7	Reset, Interrupt, and System Control Registers and Control Bits .....	63
5.7.1	Interrupt Pin Request Status and Control Register (IRQSC) .....	63
5.7.2	System Reset Status Register (SRS) .....	65
5.7.3	System Background Debug Force Reset Register (SBDFR) .....	66
5.7.4	System Options Register 1 (SOPT1) .....	66
5.7.5	System Options Register 2 (SOPT2) .....	68
5.7.6	System Device Identification Register (SDIDH, SDIDL) .....	69
5.7.7	System Power Management Status and Control 1 Register (SPMSC1) .....	70
5.7.8	System Power Management Status and Control 2 Register (SPMSC2) .....	71

## Chapter 6 Parallel Input/Output

6.1	Introduction .....	73
6.2	Port Data and Data Direction .....	73
6.3	Pin Control .....	74
6.3.1	Internal Pullup Enable .....	75
6.3.2	Output Slew Rate Control Enable .....	75
6.3.3	Output Drive Strength Select .....	75

6.4	Pin Behavior in Stop Modes .....	76
6.5	Parallel I/O and Pin Control Registers .....	76
6.5.1	Port A I/O Registers (PTAD and PTADD) .....	76
6.5.2	Port A Pin Control Registers (PTAPE, PTASE, PTADS) .....	77
6.5.3	Port B I/O Registers (PTBD and PTBDD) .....	78
6.5.4	Port B Pin Control Registers (PTBPE, PTBSE, PTBDS) .....	79
6.5.5	Port C I/O Registers (PTCD and PTCDD) .....	80
6.5.6	Port C Pin Control Registers (PTCPE, PTCSE, PTCDS) .....	81
6.5.7	Port D I/O Registers (PTDD and PTDDD) .....	82
6.5.8	Port D Pin Control Registers (PTDPE, PTDSE, PTDDS) .....	83

## Chapter 7 Central Processor Unit (S08CPUV3)

7.1	Introduction .....	85
7.1.1	Features .....	85
7.2	Programmer's Model and CPU Registers .....	86
7.2.1	Accumulator (A) .....	86
7.2.2	Index Register (H:X) .....	86
7.2.3	Stack Pointer (SP) .....	87
7.2.4	Program Counter (PC) .....	87
7.2.5	Condition Code Register (CCR) .....	87
7.3	Addressing Modes .....	89
7.3.1	Inherent Addressing Mode (INH) .....	89
7.3.2	Relative Addressing Mode (REL) .....	89
7.3.3	Immediate Addressing Mode (IMM) .....	89
7.3.4	Direct Addressing Mode (DIR) .....	89
7.3.5	Extended Addressing Mode (EXT) .....	90
7.3.6	Indexed Addressing Mode .....	90
7.4	Special Operations .....	91
7.4.1	Reset Sequence .....	91
7.4.2	Interrupt Sequence .....	91
7.4.3	Wait Mode Operation .....	92
7.4.4	Stop Mode Operation .....	92
7.4.5	BGND Instruction .....	93
7.5	HCS08 Instruction Set Summary .....	94

## Chapter 8 Internal Clock Source (S08ICSV3)

8.1	Introduction .....	105
8.1.1	Features .....	107
8.1.2	Block Diagram .....	107
8.1.3	Modes of Operation .....	108
8.2	External Signal Description .....	109
8.3	Register Definition .....	109
8.3.1	ICS Control Register 1 (ICSC1) .....	110

8.3.2	ICS Control Register 2 (ICSC2)	111
8.3.3	ICS Trim Register (ICSTRM)	112
8.3.4	ICS Status and Control (ICSSC)	112
8.4	Functional Description	114
8.4.1	Operational Modes	114
8.4.2	Mode Switching	116
8.4.3	Bus Frequency Divider	117
8.4.4	Low Power Bit Usage	117
8.4.5	DCO Maximum Frequency with 32.768 kHz Oscillator	117
8.4.6	Internal Reference Clock	117
8.4.7	External Reference Clock	118
8.4.8	Fixed Frequency Clock	118
8.4.9	Local Clock	118

## Chapter 9 16-Bit Timer/PWM (S08TPMV3)

9.1	Introduction	119
9.1.1	TPMV3 Differences from Previous Versions	120
9.1.2	Migrating from TPMV1	122
9.1.3	Features	124
9.1.4	Modes of Operation	124
9.1.5	Block Diagram	125
9.2	Signal Description	127
9.2.1	Detailed Signal Descriptions	127
9.3	Register Definition	130
9.3.1	TPM Status and Control Register (TPMxSC)	130
9.3.2	TPM-Counter Registers (TPMxCNTH:TPMxCNTL)	131
9.3.3	TPM Counter Modulo Registers (TPMxMODH:TPMxMODL)	132
9.3.4	TPM Channel n Status and Control Register (TPMxCnSC)	133
9.3.5	TPM Channel Value Registers (TPMxCnVH:TPMxCnVL)	134
9.4	Functional Description	136
9.4.1	Counter	136
9.4.2	Channel Mode Selection	137
9.5	Reset Overview	140
9.5.1	General	140
9.5.2	Description of Reset Operation	141
9.6	Interrupts	141
9.6.1	General	141
9.6.2	Description of Interrupt Operation	141

## Chapter 10 Interrupt Priority Controller (S08IPCV1)

10.1	Introduction	143
10.1.1	Features	145
10.1.2	Modes of Operation	145

10.1.3	Block Diagram .....	145
10.2	External Signal Description .....	146
10.2.1	INTIN[47:0] — Interrupt Source Interrupt Request Input .....	147
10.2.2	VFETCH — Vector Fetch Indicator from HCS08 CPU .....	147
10.2.3	IADB[5:0] — Address Bus Input from HCS08 CPU .....	147
10.2.4	INTOUT[47:0] — Interrupt Request to HCS08 CPU .....	147
10.3	Register Definition .....	147
10.3.1	IPC Status and Control Register (IPCSC) .....	147
10.3.2	Interrupt Priority Mask Pseudo Stack Register (IPMPS) .....	148
10.3.3	Interrupt Level Setting Registers (ILRS0–ILRS11) .....	149
10.4	Functional Description .....	150
10.4.1	Interrupt Priority Level Register .....	150
10.4.2	Interrupt Priority Level Comparator Set .....	150
10.4.3	Interrupt Priority Mask Update and Restore Mechanism .....	150
10.4.4	The Integration and Application of the IPC .....	151
10.5	Application Examples .....	152
10.6	Initialization/Application Information .....	153

## Chapter 11 16-Bit Modulo Timer (S08MTIM16V1)

11.1	Introduction .....	155
11.2	Features .....	157
11.2.1	Block Diagram .....	157
11.2.2	Modes of Operation .....	157
11.3	External Signal Description .....	158
11.3.1	TCLK — External Clock Source Input into MTIM16 .....	158
11.4	Register Definition .....	158
11.4.1	MTIM16 Status and Control Register (MTIMSC) .....	159
11.4.2	MTIM16 Clock Configuration Register (MTIMCLK) .....	160
11.4.3	MTIM16 Counter Register High/Low (MTIMCNTH:L) .....	161
11.4.4	MTIM16 Modulo Register High/Low (MTIMMODH/MTIMMODL) .....	162
11.5	Functional Description .....	163
11.5.1	MTIM16 Operation Example .....	164

## Chapter 12 Analog-to-Digital Converter (S08ADC12V1)

12.1	Introduction .....	167
12.1.1	ADC Channel Assignments .....	167
12.1.2	Alternate Clock .....	168
12.1.3	Hardware Trigger .....	168
12.1.4	Features .....	170
12.1.5	ADC Module Block Diagram .....	170
12.2	External Signal Description .....	171
12.2.1	Analog Power ( $V_{DDA}$ ) .....	172
12.2.2	Analog Ground ( $V_{SSA}$ ) .....	172

12.2.3	Voltage Reference High ( $V_{REFH}$ ) .....	172
12.2.4	Voltage Reference Low ( $V_{REFL}$ ) .....	172
12.2.5	Analog Channel Inputs (ADx) .....	172
12.3	Register Definition .....	172
12.3.1	Status and Control Register 1 (ADCSC1) .....	172
12.3.2	Status and Control Register 2 (ADCSC2) .....	174
12.3.3	Data Result High Register (ADCRH) .....	175
12.3.4	Data Result Low Register (ADCRL) .....	175
12.3.5	Compare Value High Register (ADCCVH) .....	176
12.3.6	Compare Value Low Register (ADCCVL) .....	176
12.3.7	Configuration Register (ADCCFG) .....	176
12.3.8	Pin Control 1 Register (APCTL1) .....	178
12.3.9	Pin Control 2 Register (APCTL2) .....	179
12.3.10	Pin Control 3 Register (APCTL3) .....	180
12.4	Functional Description .....	181
12.4.1	Clock Select and Divide Control .....	181
12.4.2	Input Select and Pin Control .....	182
12.4.3	Hardware Trigger .....	182
12.4.4	Conversion Control .....	182
12.4.5	Automatic Compare Function .....	185
12.4.6	MCU Wait Mode Operation .....	186
12.4.7	MCU Stop3 Mode Operation .....	186
12.4.8	MCU Stop2 Mode Operation .....	187
12.5	Initialization Information .....	187
12.5.1	ADC Module Initialization Example .....	187
12.6	Application Information .....	189
12.6.1	External Pins and Routing .....	189
12.6.2	Sources of Error .....	191

## Chapter 13

### Serial Communications Interface (S08SCIV4)

13.1	Introduction .....	195
13.1.1	Features .....	197
13.1.2	Modes of Operation .....	197
13.1.3	Block Diagram .....	197
13.2	Register Definition .....	200
13.2.1	SCI Baud Rate Registers (SCIBDH, SCIBDL) .....	200
13.2.2	SCI Control Register 1 (SCIC1) .....	201
13.2.3	SCI Control Register 2 (SCIC2) .....	202
13.2.4	SCI Status Register 1 (SCIS1) .....	203
13.2.5	SCI Status Register 2 (SCIS2) .....	205
13.2.6	SCI Control Register 3 (SCIC3) .....	206
13.2.7	SCI Data Register (SCID) .....	207
13.3	Functional Description .....	207
13.3.1	Baud Rate Generation .....	207

13.3.2	Transmitter Functional Description .....	208
13.3.3	Receiver Functional Description .....	209
13.3.4	Interrupts and Status Flags .....	211
13.3.5	Additional SCI Functions .....	212

## Chapter 14 Development Support

14.1	Introduction .....	215
14.1.1	Features .....	216
14.2	Background Debug Controller (BDC) .....	216
14.2.1	BKGD Pin Description .....	217
14.2.2	Communication Details .....	218
14.2.3	BDC Commands .....	221
14.2.4	BDC Hardware Breakpoint .....	224
14.3	On-Chip Debug System (DBG) .....	225
14.3.1	Comparators A and B .....	225
14.3.2	Bus Capture Information and FIFO Operation .....	225
14.3.3	Change-of-Flow Information .....	226
14.3.4	Tag vs. Force Breakpoints and Triggers .....	226
14.3.5	Trigger Modes .....	227
14.3.6	Hardware Breakpoints .....	229
14.4	Register Definition .....	229
14.4.1	BDC Registers and Control Bits .....	229
14.4.2	System Background Debug Force Reset Register (SBDFR) .....	231
14.4.3	DBG Registers and Control Bits .....	232





# Chapter 1

## Device Overview

### 1.1 Introduction

MC9S08FL16 series MCUs are members of the low-cost, high-performance HCS08 family of 8-bit microcontroller units (MCUs). All MCUs in the family use the enhanced HCS08 core and are available with a variety of modules and package types.

[Table 1-1](#) summarizes the peripheral availability per package type for the devices available in the MC9S08FL16 series.

**Table 1-1. Devices in the MC9S08FL16 Series**

Feature	Device	
	MC9S08FL16	MC9S08FL8
Package	32-pin	
Flash	16,384 bytes	8,192 bytes
RAM	1,024 bytes	768 bytes
IRQ	yes	
IPC	yes	
TPM1	4-ch 16-bit	
TPM2	2-ch 16-bit	
MTIM16	16-bit	
ADC	12-ch 8-bit	
SCI	yes	
I/O pins	30	
Package types	32-pin LQFP 32-pin SDIP	

## 1.2 MCU Block Diagram

The block diagram in Figure 1-1 shows the structure of the MC9S08FL16 series MCUs.

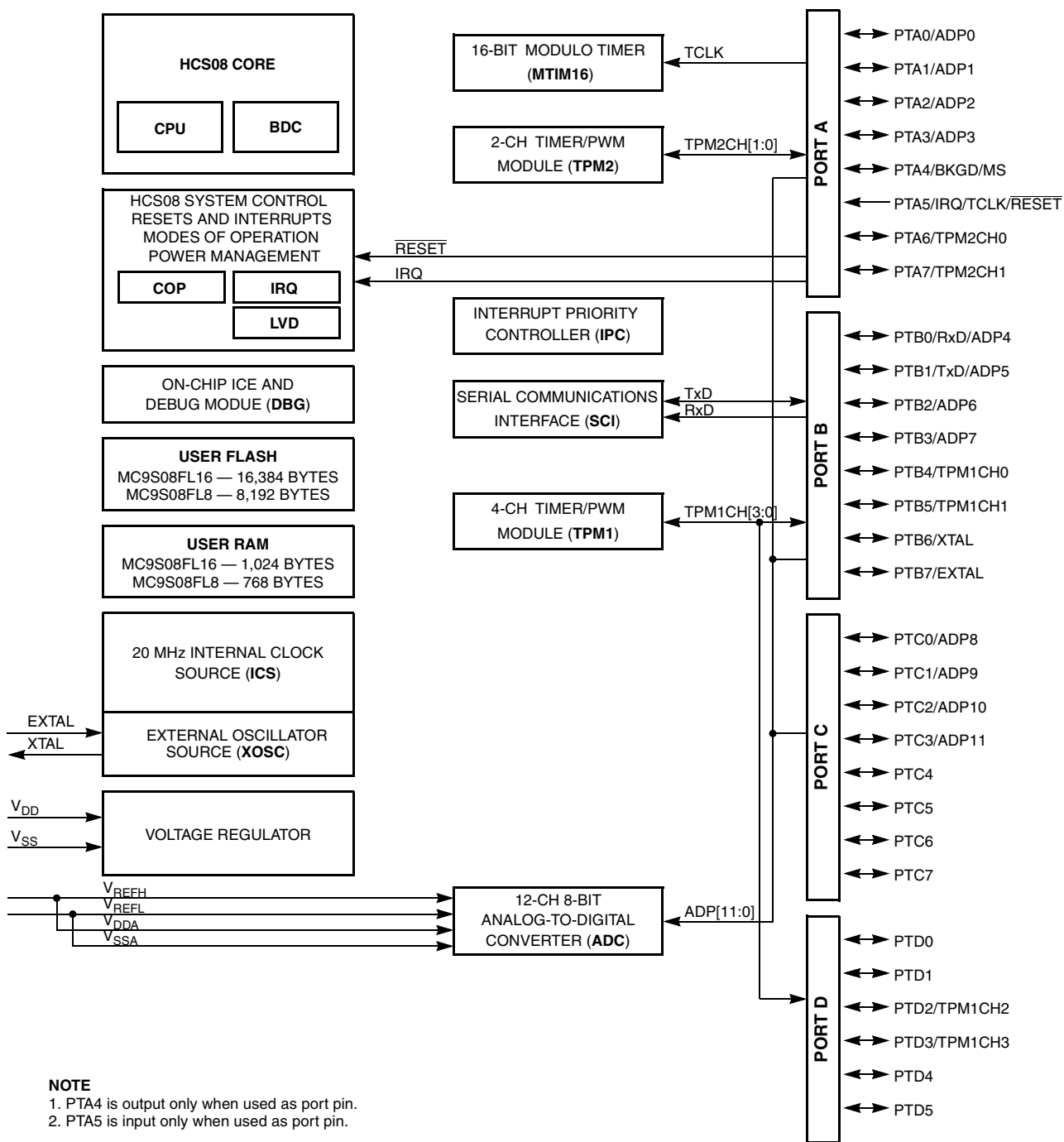

Figure 1-1. MC9S08FL16 Block Diagram

Table 1-2 lists the functional versions of the on-chip modules.

**Table 1-2. Versions of On-Chip Modules**

Module		Version
Analog-to-Digital Converter	(ADC)	1
Central Processing Unit	(CPU)	3
Debug Module	(DBG)	2
Interrupt Priority Controller	(IPC)	1
Internal Clock Source	(ICS)	3
16-Bit Modulo Timer	(MTIM16)	1
Serial Communications Interface	(SCI)	4
Timer and Pulse-Width Modulator	(TPM)	3

### 1.3 System Clock Distribution

MC9S08FL16 series use ICS module as clock sources. The ICS module can use internal or external clock source as reference to provide up to 20 MHz CPU clock. The output of ICS module includes

- OSCOUT — XOSC output provides external reference clock to ADC.
- ICSFFCLK — ICS fixed frequency clock reference (around 32.768 kHz) provides double of the fixed lock signal to TPMs and MTIM16.
- ICSOUT — ICS CPU clock provides double of the bus clock which is basic clock reference of peripherals.
- ICSLCLK — Alternate BDC clock provides debug signal to BDC module.

The TCLK pin is an extra external clock source. When TCLK is enabled, it can provide alternate clock source to TPMs and MTIM16. See [Section 5.7.4, “System Options Register 1 \(SOPT1\)”](#) for details.

The on-chip 1 kHz clock can provide clock source of COP module.

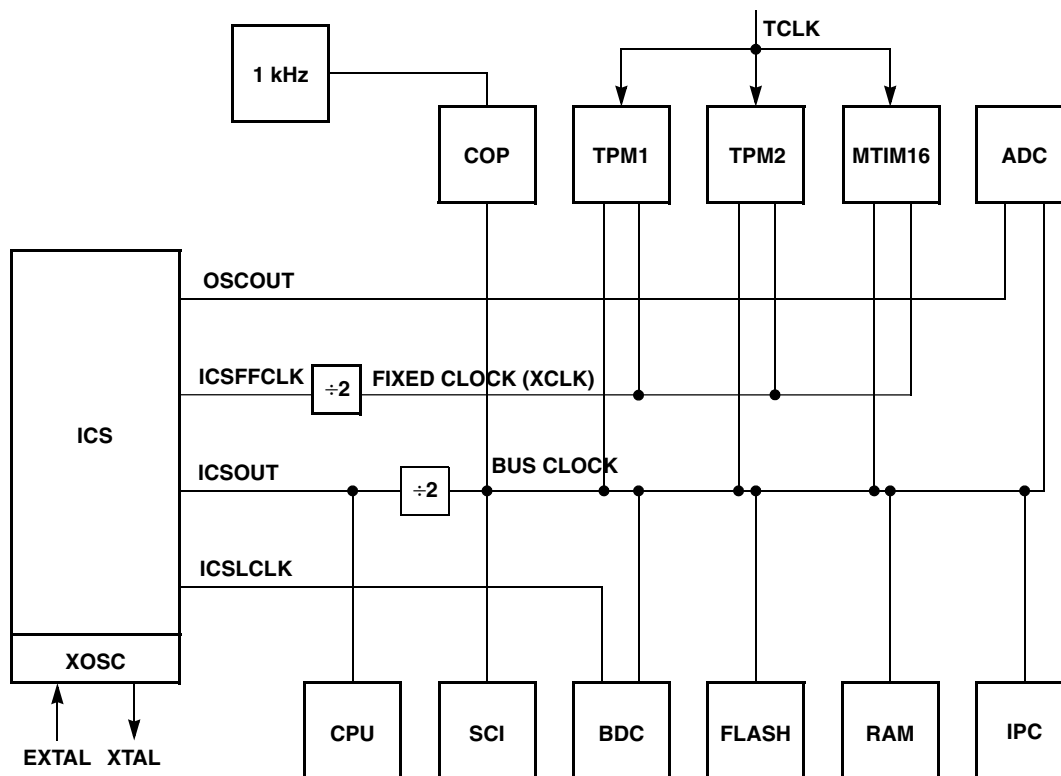

Figure 1-2. System Clock Distribution Diagram

# Chapter 2 Pins and Connections

## 2.1 Introduction

This chapter describes signals that connect to package pins. It includes a pinout diagram, a table of signal properties, and a detailed discussion of signals.

## 2.2 Device Pin Assignment

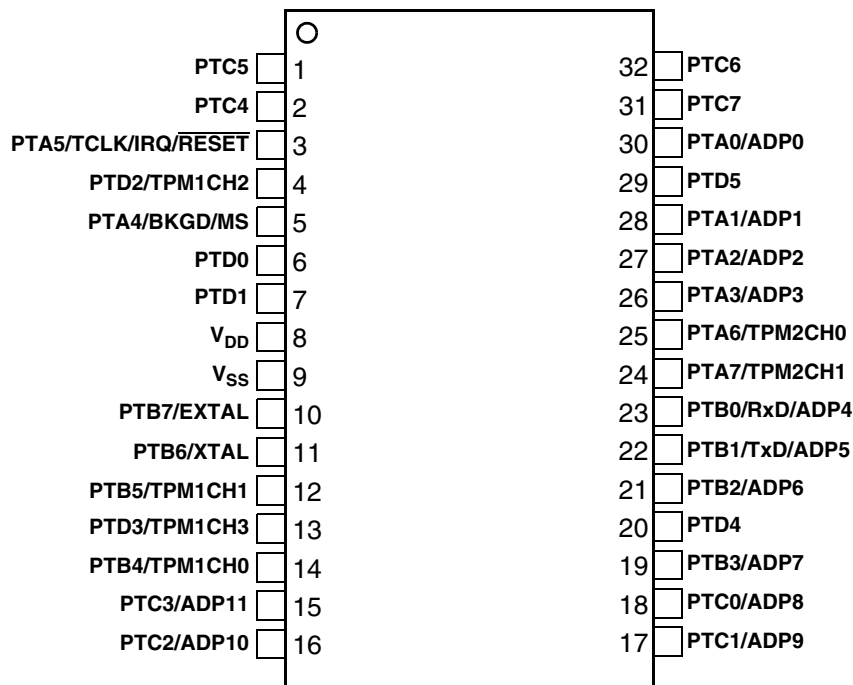

Figure 2-1. MC9S08FL16 Series 32-Pin SDIP Package

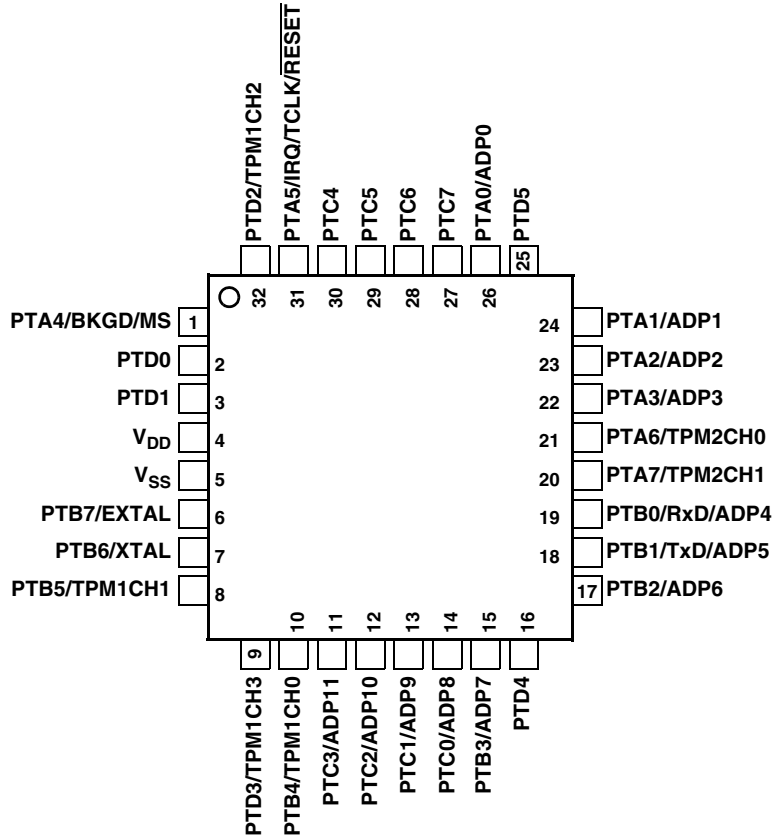
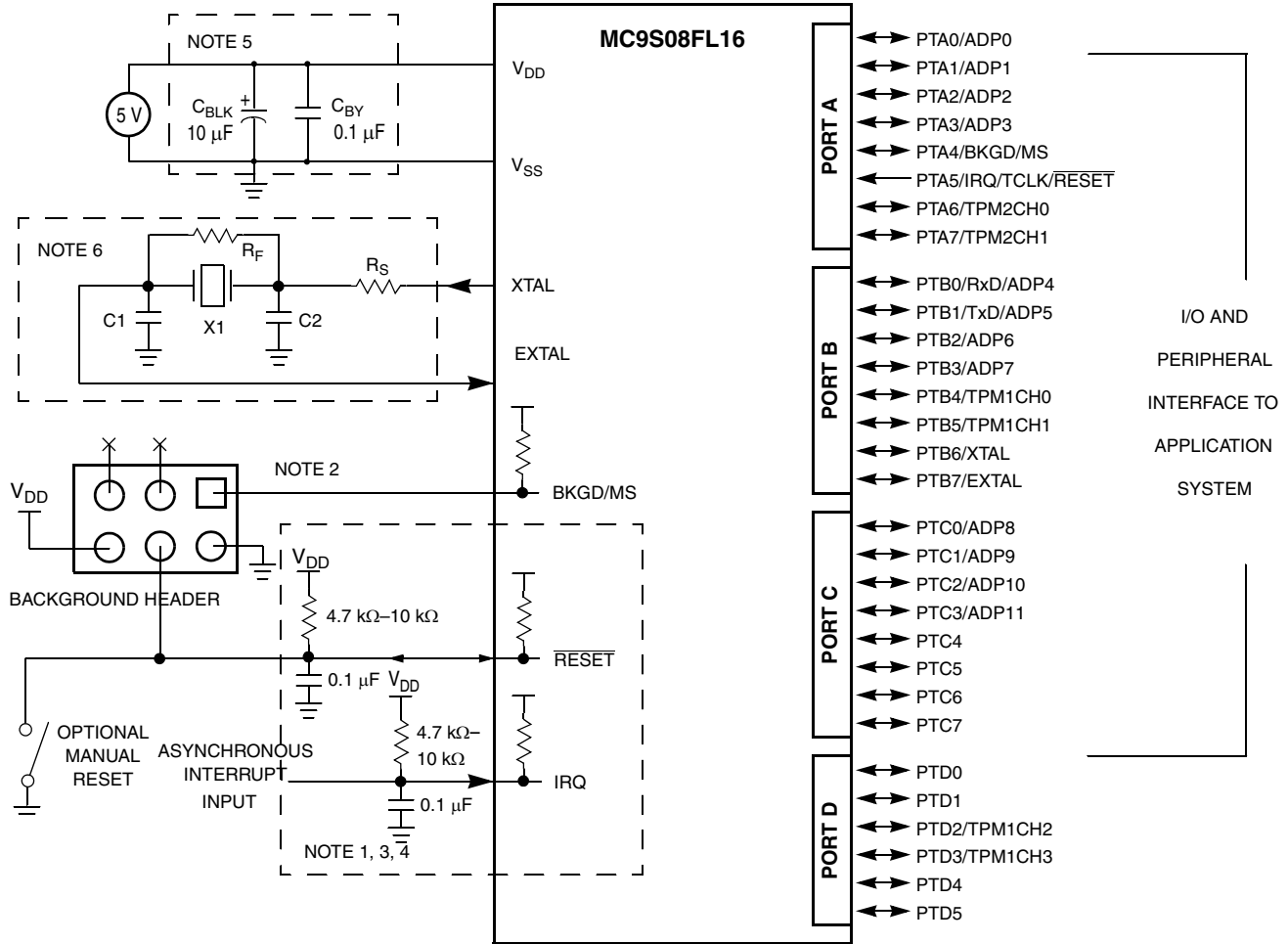

Figure 2-2. MC9S08FL16 Series 32-Pin LQFP Package

## 2.3 Recommended System Connections

Figure 2-3 shows pin connections that are common to almost all MC9S08FL16 series application systems.



NOTES:

1. RC filters on  $\overline{\text{RESET}}$  and IRQ are recommended for EMC-sensitive applications.
2. The  $\overline{\text{RESET}}$  pin can only be used to reset into user mode; you can not enter BDM using  $\overline{\text{RESET}}$  pin. BDM can be entered by holding  $\overline{\text{MS}}$  low during POR or writing a 1 to BDFR in SBDFFR with  $\overline{\text{MS}}$  low after issuing the BDM command.
3. IRQ feature has optional internal pullup device.
4. IRQ and  $\overline{\text{RESET}}$  are both multiplexed with PTA5. The recommended connection can be used for only one purpose.
5. The bulk and bypass capacitors must be placed close to MCU power supply as possible.
6. External crystal circuitry is not required if using the ICS internal clock option.

Figure 2-3. Basic System Connections

### 2.3.1 Power ( $V_{DD}$ , $V_{SS}$ )

$V_{DD}$  and  $V_{SS}$  are the primary power supply pins for the MCU. This voltage source supplies power to all I/O buffer circuitry and to an internal voltage regulator. The internal voltage regulator provides a regulated lower-voltage source to the CPU and to the MCU's other internal circuitry.

Typically, application systems have two separate capacitors across the power pins. In this case, there should be a bulk electrolytic capacitor, such as a 10  $\mu\text{F}$  tantalum capacitor, that provides bulk charge storage for the overall system and a 0.1  $\mu\text{F}$  ceramic bypass capacitor located as near to the paired  $V_{DD}$  and  $V_{SS}$  power pins as practical to suppress high-frequency noise.

### 2.3.2 Oscillator (XTAL, EXTAL)

Immediately after reset, the MCU uses an internally generated clock provided by the internal clock source (ICS) module. For more information on the ICS, see [Chapter 8, “Internal Clock Source \(S08ICSV3\).”](#)

The oscillator (XOSC) in this MCU is a Pierce oscillator that can accommodate a crystal or ceramic resonator. Rather than a crystal or ceramic resonator, an external oscillator can be connected to the EXTAL input pin.

$R_S$  (when used) and  $R_F$  must be low-inductance resistors such as carbon composition resistors.

Wire-wound resistors, and some metal film resistors, have too much inductance. C1 and C2 normally must be high-quality ceramic capacitors that are specifically designed for high-frequency applications.  $R_F$  is used to provide a bias path to keep the EXTAL input in its linear range during crystal startup; its value is not generally critical. Typical systems use 1 M to 10 M. Higher values are sensitive to humidity and lower values reduce gain and (in extreme cases) could prevent startup.

C1 and C2 are typically in the 5 pF to 25 pF range and are chosen to match the requirements of a specific crystal or resonator. Be sure to take into account printed circuit board (PCB) capacitance and MCU pin capacitance when selecting C1 and C2. The crystal manufacturer typically specifies a load capacitance which is the series combination of C1 and C2 (which are usually the same size). As a first-order approximation, use 10 pF as an estimate of combined pin and PCB capacitance for each oscillator pin (EXTAL and XTAL).

### 2.3.3 $\overline{\text{RESET}}$ and External Interrupt Pin (IRQ)

$\overline{\text{RESET}}$  shares an I/O pin with PTA5/IRQ/TCLK. The  $\overline{\text{RESET}}$  pin function is disabled in default and PTA5/IRQ/TCLK/ $\overline{\text{RESET}}$  pin acts as PTA5 after POR reset, because internal power-on reset and low-voltage reset circuitry typically make external reset circuitry unnecessary. This pin is normally connected to the standard 6-pin background debug connector so that a development system can directly reset the MCU system. If  $\overline{\text{RESET}}$  function of PTA5/IRQ/TCLK/ $\overline{\text{RESET}}$  pin is enabled, a manual external reset can be added by supplying a simple switch to ground (pull reset pin low to force a reset). When the  $\overline{\text{RESET}}$  pin function is enabled, an internal pullup resistor is connected to this pin and a reset signal can feed into MCU with an input hysteresis. This pin has no driving out function when it works as  $\overline{\text{RESET}}$  pin function. POR reset brings  $\overline{\text{RESET}}$  pin into its default state, reset other than POR has no effect on the  $\overline{\text{RESET}}$  pin function configuration.

When PTA5/IRQ/TCLK/ $\overline{\text{RESET}}$  is enabled as IRQ pin, it is the input source for the IRQ interrupt and is also the input for the BIH and BIL instructions.

When PTA5/IRQ/TCLK/ $\overline{\text{RESET}}$  is enabled as TCLK, it is the external clock source of TPMs and MTIM16.

When PTA5/IRQ/TCLK/ $\overline{\text{RESET}}$  is enabled as I/O pin, PTA5 can provide input operations only as normal GPIO.

In EMC-sensitive applications, an external RC filter is recommended on the reset pin. See [Figure 2-3](#) for an example.



### 2.3.4 Background/Mode Select (BKGD/MS)

During a power-on-reset (POR) or background debug force reset (see [Section 5.7.3, “System Background Debug Force Reset Register \(SBD FR\)”](#) for details), the PTA4/BKGD/MS pin functions as a mode select pin. Immediately after internal reset rises the pin functions as the background pin and can be used for background debug communication. While the pin functions as a background/mode selection pin, it includes an internal pullup device, input hysteresis, a standard output driver, and has not output slew rate control.

The background debug communication function is enabled when BKGDPE bit in SOPT1 is set. BKGDPE is set following any reset of the MCU and must be cleared to use the PTA4/BKGD/MS pin’s alternative pin functions.

If this pin is floating, the MCU will enter normal operating mode at the rising edge of reset. If a debug system is connected to the 6-pin standard background debug header, it can hold BKGD/MS low during the POR or immediately after issuing a background debug force reset, which will force the MCU into active background mode.

The BKGD pin is used primarily for background debug controller (BDC) communications using a custom protocol that uses 16 clock cycles of the target MCU’s BDC clock per bit time. The target MCU’s BDC clock can run as fast as the bus clock, so there should never be any significant capacitance connected to the BKGD/MS pin that interferes with background serial communications. When the pin performs output only PTA4, it can only drive capacitance-limited MOSFET. Driving a bipolar transistor by PTA4 is prohibited because this can cause mode entry fault and BKGD errors.

Although the BKGD pin is a pseudo open-drain pin, the background debug communication protocol provides brief, actively driven, high speedup pulses to ensure fast rise times. Small capacitances from cables and the absolute value of the internal pullup device play almost no role in determining rise and fall times on the BKGD pin.

### 2.3.5 General-Purpose I/O and Peripheral Ports

The MC9S08FL16 series of MCUs support up to 30 general-purpose I/O pins, which are shared with on-chip peripheral functions (TPM, ADC, SCI, etc.). These 30 general-purpose I/O pins include one output-only pin (PTA4) and one input-only pin (PTA5).

When a port pin is configured as a general-purpose output or when a peripheral uses the port pin as an output, software can select alternative drive strengths and slew rate controls. When a port pin is configured as a general-purpose input, or when a peripheral uses the port pin as an input, the software can enable a pullup device.

For information about controlling these pins as general-purpose I/O pins, see the [Chapter 6, “Parallel Input/Output.”](#) For information about how and when on-chip peripheral systems use these pins, see the appropriate module chapter.

Immediately after reset, all pins are configured as high-impedance general-purpose inputs with internal pullup devices disabled.

**Table 2-1. Pin Availability by Package Pin-Count**

Pin Number		<-- Lowest Priority --> Highest							
32-SDIP	32-LQFP	Port Pin	I/O	Alt 1	I/O	Alt 2	I/O	Alt 3	I/O
1	29	PTC5	I/O						
2	30	PTC4	I/O						
3	31	PTA5	I	IRQ	I	TCLK	I	RESET	I
4	32	PTD2	I/O			TPM1CH2	I/O		
5	1	PTA4	O			BKGD	I	MS	I
6	2	PTD0	I/O						
7	3	PTD1	I/O						
8	4							V <sub>DD</sub>	I
9	5							V <sub>SS</sub>	I
10	6	PTB7	I/O	EXTAL	I				
11	7	PTB6	I/O	XTAL	O				
12	8	PTB5	I/O			TPM1CH1	I/O		
13	9	PTD3	I/O			TPM1CH3	I/O		
14	10	PTB4	I/O			TPM1CH0	I/O		
15	11	PTC3	I/O			ADP11	I		
16	12	PTC2	I/O			ADP10	I		
17	13	PTC1	I/O			ADP9	I		
18	14	PTC0	I/O			ADP8	I		
19	15	PTB3	I/O			ADP7	I		
20	16	PTD4	I/O						
21	17	PTB2	I/O			ADP6	I		
22	18	PTB1	I/O			TxD	I/O	ADP5	I
23	19	PTB0	I/O			RxD	I	ADP4	I
24	20	PTA7	I/O			TPM2CH1	I/O		
25	21	PTA6	I/O			TPM2CH0	I/O		
26	22	PTA3	I/O			ADP3	I		
27	23	PTA2	I/O			ADP2	I		
28	24	PTA1	I/O			ADP1	I		
29	25	PTD5	I/O						
30	26	PTA0	I/O			ADP0	I		
31	27	PTC7	I/O						
32	28	PTC6	I/O						

**NOTE**

When an alternative function is first enabled, it is possible to get a spurious edge to the module. User software must clear out any associated flags before interrupts are enabled. [Table 2-1](#) illustrates the priority if multiple modules are enabled. The highest priority module will have control over the pin. Selecting a higher priority pin function with a lower priority function already enabled can cause spurious edges to the lower priority module. Disable all modules that share a pin before enabling another module.



## Chapter 3

# Modes of Operation

### 3.1 Introduction

The operating modes of the MC9S08FL16 series are described in this chapter. Entry into each mode, exit from each mode, and functionality while in each mode are described

### 3.2 Features

- Run mode for normal operating
- Active background mode for code development
- Wait mode:
  - CPU halts operation to conserve power
  - System clocks continue running
  - Full voltage regulation is maintained
- Stop modes: CPU and bus clocks stopped
  - Stop2: Partial power down of internal circuits; RAM contents retained
  - Stop3: All internal circuits are powered for fast recovery; RAM and register contents are retained

### 3.3 Run Mode

Run is the normal operating mode for the MC9S08FL16 series. This mode is selected upon the MCU exiting reset if the PTA4/BKGD/MS pin is high. In this mode, the CPU executes code from internal memory beginning at the address 0xFFFFE:0xFFFF after reset.

### 3.4 Active Background Mode

The active background mode functions are managed through the background debug controller (BDC) in the HCS08 core. The BDC provides the means for analyzing MCU operation during software development.

Active background mode is entered in any of six ways:

- When PTA4/BKGD/MS is low during POR
- When PTA4/BKGD/MS is low immediately after issuing a background debug force reset when the pin is configured to BKGD/MS function (see [Section 5.7.3, “System Background Debug Force Reset Register \(SBD FR\)”](#))
- When a BACKGROUND command is received through the BKGD pin

- When a BGND instruction is executed
- When encountering a BDC breakpoint
- When encountering a DBG breakpoint

After entering active background mode, the CPU stays in a suspended state waiting for serial background commands rather than executing instructions from the user application program.

Background commands are of two types:

- Non-intrusive commands, defined as commands that can be issued while the user program is running. Non-intrusive commands can be issued through the BKGD pin while the MCU is in run mode; non-intrusive commands can also be executed when the MCU is in the active background mode. Non-intrusive commands include:
  - Memory access commands
  - Memory-access-with-status commands
  - BDC register access commands
  - The BACKGROUND command
- Active background commands: Commands that can only be executed while the MCU is in active background mode. Active background commands include commands to:
  - Read or write CPU registers
  - Trace one user program instruction at a time
  - Leave active background mode to return to the user application program (GO)

Active background mode is used to program bootloader or user application programs into the flash program memory before the MCU operates in run mode for the first time. When the MC9S08FL16 series are shipped from Freescale Semiconductor Inc., the flash program memory is erased by default unless specifically noted, so there is no program that can execute in run mode until the flash memory is initially programmed. The active background mode can also be used to erase and reprogram the flash memory after it is programmed.

For additional information about the active background mode, refer to the [Chapter 14, “Development Support.”](#)

### 3.5 Wait Mode

Wait mode is entered by executing a WAIT instruction. Upon execution of the WAIT instruction, the CPU enters a low-power state in which it is not clocked. The I bit in the condition code register (CCR) is cleared when the CPU enters wait mode, enabling interrupts. When an interrupt request occurs, the CPU exits wait mode and resumes processing, beginning with the stacking operations leading to the interrupt service routine.

While the MCU is in wait mode, not all background debug commands can be used. Only the background command and memory-access-with-status commands are available while the MCU is in wait mode. The memory-access-with-status commands do not allow memory access, but they report an error indicating that the MCU is in either stop or wait mode. The background command can be used to wake the MCU from wait mode and enter active background mode.

## 3.6 Stop Modes

Stop modes is entered upon execution of a STOP instruction when the STOPE bit in the system option register (SOPT1) is set. In stop mode, the bus and CPU clocks are halted. The ICS module can be configured to keep the reference clocks running. See [Chapter 8, “Internal Clock Source \(S08ICSV3\),”](#) for more information.

The MC9S08FL16 series of MCUs do not support stop1 mode.

[Table 3-1](#) shows all of the control bits that affect stop mode selection and the mode selected under various conditions. It enters the selected mode by executing a STOP instruction.

**Table 3-1. Stop Mode Selection**

STOPE	ENBDM <sup>1</sup>	LVDE	LVDSE	PPDC	Stop Mode
0	x	x		x	Stop modes disabled; illegal opcode reset if STOP instruction executed
1	1	x		x	Stop3 with BDM enabled <sup>2</sup>
1	0	Both bits must be 1		x	Stop3 with voltage regulator active
1	0	Either bit a 0		0	Stop3
1	0	Either bit a 0		1	Stop2

<sup>1</sup> ENBDM is located in the BDCSCR which is accessible through only the BDC commands, see [Section 14.4.1.1, “BDC Status and Control Register \(BDCSCR\).”](#)

<sup>2</sup> When in stop3 mode with BDM enabled, the  $SI_{DD}$  will be near  $RI_{DD}$  levels because internal clocks are enabled.

### 3.6.1 Stop3 Mode

Stop3 mode is entered by executing a STOP instruction under the conditions as shown in [Table 3-1](#). The states of all the internal registers and logic, as well as RAM contents, are maintained. The I/O pin states are held.

Exit from stop3 by asserting  $\overline{RESET}$  or any asynchronous interrupt. Asynchronous interrupts can come from SCI, ADC, LVW, and IRQ.

If stop3 is exited by asserting of the  $\overline{RESET}$  pin, then the MCU is reset and operation will resume after taking the reset vector. If exited by asynchronous interrupt, the MCU will take the appropriate interrupt vector.

#### 3.6.1.1 LVD Enabled in Stop Mode

The LVD system can generate an interrupt or a reset when the supply voltage drops below the LVD voltage. The LVD is enabled in stop (LVDE and LVDSE bits in SPMSC1 both set) at the time the CPU executes a STOP instruction. The voltage regulator remains active during stop mode. If the user attempts to enter stop2 with the LVD enabled for stop, the MCU will enter stop3 instead.

The LVD must be enabled to keep the ADC working in stop3.

### 3.6.1.2 Active BDM Enabled in Stop Mode

Entry into the active background mode from run mode is enabled if the ENBDM bit in BDCSCR is set. This register is described in [Chapter 14, “Development Support.”](#) If ENBDM is set when the CPU executes a STOP instruction, the system clocks for the background debug logic remain active when the MCU enters stop mode. As a result, background debug communication is still possible. In addition, the voltage regulator does not enter its low-power standby state but maintains full internal regulation. If the user attempts to enter stop2 with ENBDM set, the MCU enters stop3 instead.

Most background commands are not available in stop mode. The memory-access-with-status commands do not allow memory access, but they report an error indicating that the MCU is in stop or wait mode. The background command can be used to wake the MCU from stop and enter active background mode if the ENBDM bit is set. After background debug mode is entered, all background commands are available.

## 3.6.2 Stop2 Mode

Stop2 mode is entered by executing a STOP instruction under the conditions as shown in [Table 3-1](#). Most of the internal circuitry except for RAM in MCU is powered off in stop2. Upon entering stop2, all I/O pin control signals are latched so that the pins retain their states during stop2.

Exit from stop2 is performed by asserting any wakeup pin. The wakeup pins include  $\overline{\text{RESET}}$  or  $\overline{\text{IRQ}}$ .

Upon wakeup from stop2 mode, the MCU starts up as from a power-on reset (POR):

- All module control and status registers are reset.
- The LVD reset function is enabled and the MCU remains in the reset state if  $V_{DD}$  is below the LVD trip point (low trip point selected due to POR).
- The CPU takes the reset vector.

In addition to the above, upon waking from stop2, the PPDF bit in SPMSC2 is set. This flag directs user code to stop2 recovery routine. PPDF remains set and the I/O pin states remain latched until a 1 is written to PPDACK bit in SPMSC2.

To maintain I/O states of general-purpose I/O, the user must restore the contents of the I/O port registers saved in RAM before writing to the PPDACK bit. Otherwise, the pins will switch to their reset states when PPDACK is written.

For pins that were configured as peripheral I/O, the user must reconfigure the peripheral module that interfaces to the pin before writing to the PPDACK bit. If the peripheral module is not enabled before writing to PPDACK, the pins will be controlled by their associated port control registers when the I/O latches are opened.

## 3.6.3 On-Chip Peripheral Modules in Stop Modes

When MCU enters any stop mode, the system clocks for the internal peripheral modules stop. Even in the exception case ( $\text{ENBDM} = 1$ ), where clocks for the background debug logic continue to operate, clocks to the peripheral systems are halted to reduce power consumption. Refer to [Section 3.6.2, “Stop2 Mode,”](#) and [Section 3.6.1, “Stop3 Mode,”](#) for specific information on system behavior in stop modes.



**Table 3-2. Stop Mode Behavior**

Peripheral	Mode	
	Stop2	Stop3
CPU	Off	Standby
RAM	Standby	Standby
Flash	Off	Standby
Parallel Port Registers	Off	Standby
IPC	Off	Standby
ADC	Off	Optionally On <sup>1</sup>
ICS	Off	Optionally On <sup>2</sup>
SCI	Off	Standby
TPM	Off	Standby
MTIM16	Off	Standby
System Voltage Regulator	Standby	Standby
I/O Pins	States Held	States Held

<sup>1</sup> Requires the asynchronous ADC clock and LVD to be enabled, else in standby.

<sup>2</sup> IRCLKEN and IREFSTEN are set in ICSC1, else in standby.



## Chapter 4 Memory

### 4.1 MC9S08FL16 Series Memory Map

Figure 4-1 shows the memory map for the MC9S08FL16 series. On-chip memory in the MC9S08FL16 series of MCUs consists of RAM, flash program memory for nonvolatile data storage, plus I/O and control/status registers. The registers are divided into two groups:

- Direct-page registers (0x0000 through 0x003F)
- High-page registers (0x1800 through 0x187F)

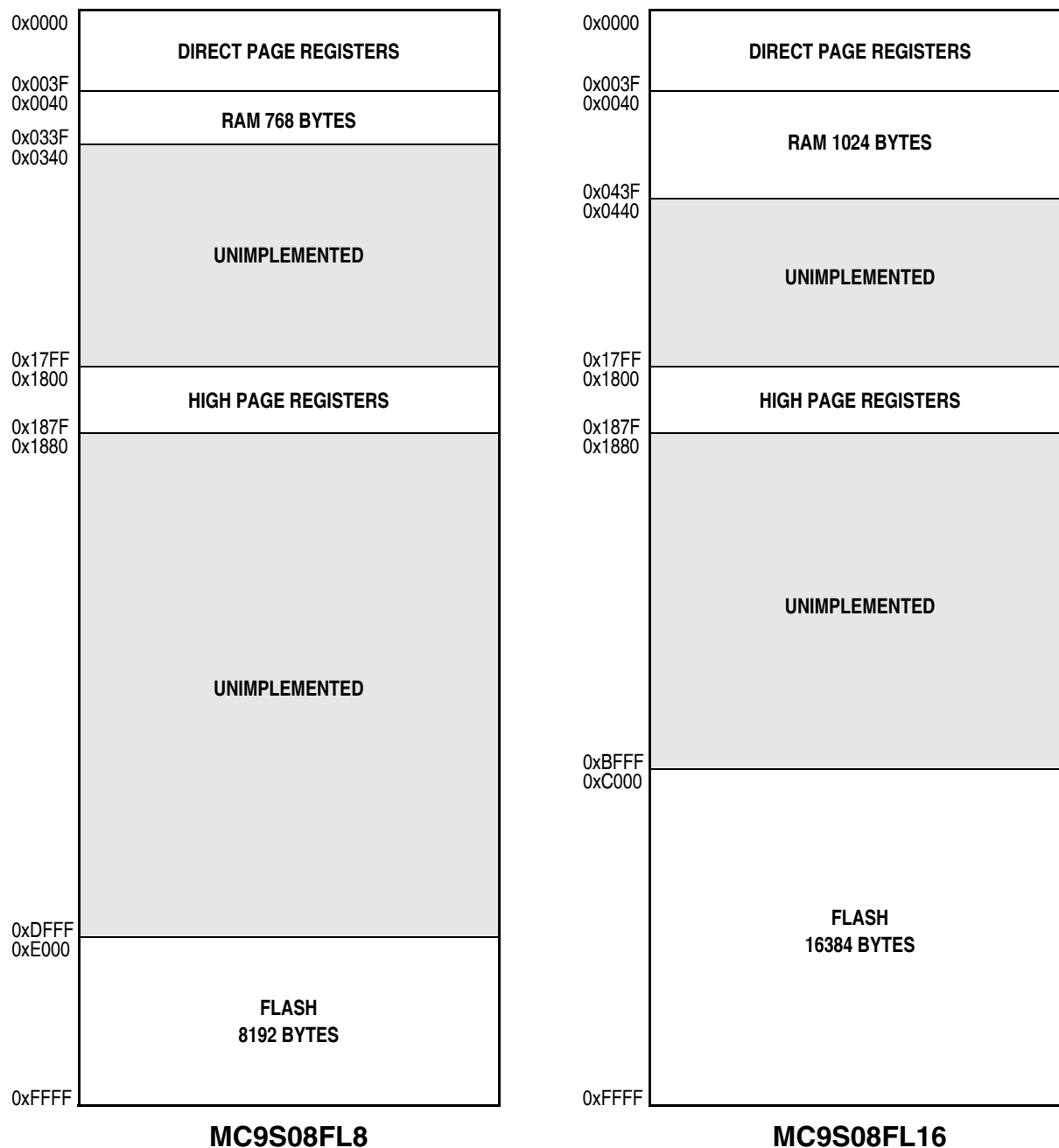

Figure 4-1. MC9S08FL16 Series Memory Map

## 4.1.1 Reset and Interrupt Vector Assignments

Table 4-1 shows address assignments for reset and interrupt vectors. The vector names shown in this table are the labels used in the Freescale-provided equate file for the MC9S08FL16 series. For more details about resets, interrupts, interrupt priority, and local interrupt mask controls, refer to Chapter 5, “Resets, Interrupts, and System Configuration.”

**Table 4-1. Reset and Interrupt Vectors**

Address (High/Low)	Vector	Vector Name
0xFFC0:0xFFC1 to 0xFFD0:FFD1	Unused Vector Space	—
0xFFD2:FFD3	SCI Transmit	Vscierr
0xFFD4:FFD5	SCI Receive	Vscirx
0xFFD6:FFD7	SCI Error	Vscitx
0xFFD8:FFD9	Unused	—
0xFFDA:FFDB	Unused	—
0xFFDC:FFDD	ADC Conversion	Vadc
0xFFDE:FFDF	TPM2 Overflow	Vtpm2ovf
0xFFE0:FFE1	TPM2 Channel 1	Vtpm2ch1
0xFFE2:FFE3	TPM2 Channel 0	Vtpm2ch0
0xFFE4:FFE5	TPM1 Overflow	Vtpm1ovf
0xFFE6:FFE7	Unused	—
0xFFE8:FFE9	Unused	—
0xFFEA:FFEB	TPM1 Channel 3	Vtpm1ch3
0xFFEC:FFED	TPM1 Channel 2	Vtpm1ch2
0xFFEE:FFEF	TPM1 Channel 1	Vtpm1ch1
0xFFF0:FFF1	TPM1 Channel 0	Vtpm1ch0
0xFFF2:FFF3	MTIM16	Vmtim
0xFFF4:FFF5	Unused	—
0xFFF6:FFF7	Unused	—
0xFFF8:FFF9	Low Voltage Warning	Vlvd
0xFFFA:FFFB	IRQ	Virq
0xFFFC:FFFD	SWI	Vswi
0xFFFE:FFFF	Reset	Vreset

## 4.2 Register Addresses and Bit Assignments

The registers in the MC9S08FL16 series are divided into two groups:

- Direct-page registers are located in the first 64 locations in the memory map, so they are accessible with efficient direct addressing mode instructions.
- High-page registers are used much less often, so they are located above 0x1800 in the memory map. This leaves room in the direct page for more frequently used registers and variables.

Direct-page registers can be accessed with efficient direct addressing mode instructions. Bit manipulation instructions can be used to access any bit in a direct-page register. Table 4-2 is a summary of all user-accessible direct-page registers and control bits.

The direct-page registers in Table 4-2 can use the more efficient direct addressing mode which requires only the lower byte of the address. Because of this, the lower byte of the address in column one is shown in bold text. In Table 4-3 and Table 4-4, the whole address in column one is shown in bold. In Table 4-2, Table 4-3, and Table 4-4, the register names in column two are shown in bold to set them apart from the bit names to the right. Cells that are not associated with named bits are shaded. A shaded cell with a 0 indicates this unused bit always reads as a 0. Shaded cells with dashes indicate unused or reserved bit locations that could read as 1s or 0s.

**Table 4-2. Direct-Page Register Summary (Sheet 1 of 2)**

Address	Register Name	Bit 7	6	5	4	3	2	1	Bit 0
0x0000	<b>ADCSC1</b>	COCO	AIEN	ADCO	ADCH				
0x0001	<b>ADCSC2</b>	ADACT	ADTRG	ACFE	ACFGT	0	0	R	R
0x0002	Reserved	—	—	—	—	—	—	—	—
0x0003	<b>ADCRL</b>	ADR7	ADR6	ADR5	ADR4	ADR3	ADR2	ADR1	ADR0
0x0004	Reserved	—	—	—	—	—	—	—	—
0x0005	<b>ADCCVL</b>	ADCV7	ADCV6	ADCV5	ADCV4	ADCV3	ADCV2	ADCV1	ADCV0
0x0006	<b>ADCCFG</b>	ADLPC	ADIV		ADLSMP	MODE		ADICLK	
0x0007	<b>APCTL1</b>	ADPC7	ADPC6	ADPC5	ADPC4	ADPC3	ADPC2	ADPC1	ADPC0
0x0008	<b>APCTL2</b>	—	—	—	—	ADPC11	ADPC10	ADPC9	ADPC8
0x0009– 0x000A	Reserved	—	—	—	—	—	—	—	—
0x000B	<b>IRQSC</b>	0	IRQPDD	IRQEDG	IRQPE	IRQF	IRQACK	IRQIE	IRQMOD
0x000C– 0x000F	Reserved	—	—	—	—	—	—	—	—
0x0010	<b>TPM2SC</b>	TOF	TOIE	CPWMS	CLKSB	CLKSA	PS2	PS1	PS0
0x0011	<b>TPM2CNTH</b>	Bit 15	Bit 14	Bit 13	Bit 12	Bit 11	Bit 10	Bit 9	Bit 8
0x0012	<b>TPM2CNTL</b>	Bit 7	Bit 6	Bit 5	Bit 4	Bit 3	Bit 2	Bit 1	Bit 0
0x0013	<b>TPM2MODH</b>	Bit 15	Bit 14	Bit 13	Bit 12	Bit 11	Bit 10	Bit 9	Bit 8
0x0014	<b>TPM2MODL</b>	Bit 7	Bit 6	Bit 5	Bit 4	Bit 3	Bit 2	Bit 1	Bit 0
0x0015	<b>TPM2C0SC</b>	CH0F	CH0IE	MS0B	MS0A	ELS0B	ELS0A	0	0
0x0016	<b>TPM2C0VH</b>	Bit 15	Bit 14	Bit 13	Bit 12	Bit 11	Bit 10	Bit 9	Bit 8
0x0017	<b>TPM2C0VL</b>	Bit 7	Bit 6	Bit 5	Bit 4	Bit 3	Bit 2	Bit 1	Bit 0
0x0018	<b>TPM2C1SC</b>	CH1F	CH1IE	MS1B	MS1A	ELS1B	ELS1A	0	0
0x0019	<b>TPM2C1VH</b>	Bit 15	Bit 14	Bit 13	Bit 12	Bit 11	Bit 10	Bit 9	Bit 8
0x001A	<b>TPM2C1VL</b>	Bit 7	Bit 6	Bit 5	Bit 4	Bit 3	Bit 2	Bit 1	Bit 0
0x001B– 0x001D	Reserved	—	—	—	—	—	—	—	—
0x001E	<b>IPCSC</b>	IPCE	0	PSE	PSF	PULIPM	0	IPM	
0x001F	<b>IPMPS</b>	IPM3		IPM2		IPM1		IPM0	
0x0020	<b>TPM1SC</b>	TOF	TOIE	CPWMS	CLKSB	CLKSA	PS2	PS1	PS0
0x0021	<b>TPM1CNTH</b>	Bit 15	Bit 14	Bit 13	Bit 12	Bit 11	Bit 10	Bit 9	Bit 8

**Table 4-2. Direct-Page Register Summary (Sheet 2 of 2) (continued)**

Address	Register Name	Bit 7	6	5	4	3	2	1	Bit 0
0x0022	TPM1CNTL	Bit 7	Bit 6	Bit 5	Bit 4	Bit 3	Bit 2	Bit 1	Bit 0
0x0023	TPM1MODH	Bit 15	Bit 14	Bit 13	Bit 12	Bit 11	Bit 10	Bit 9	Bit 8
0x0024	TPM1MODL	Bit 7	Bit 6	Bit 5	Bit 4	Bit 3	Bit 2	Bit 1	Bit 0
0x0025	TPM1C0SC	CH0F	CH0IE	MS0B	MS0A	ELS0B	ELS0A	0	0
0x0026	TPM1C0VH	Bit 15	Bit 14	Bit 13	Bit 12	Bit 11	Bit 10	Bit 9	Bit 8
0x0027	TPM1C0VL	Bit 7	Bit 6	Bit 5	Bit 4	Bit 3	Bit 2	Bit 1	Bit 0
0x0028	TPM1C1SC	CH1F	CH1IE	MS1B	MS1A	ELS1B	ELS1A	0	0
0x0029	TPM1C1VH	Bit 15	Bit 14	Bit 13	Bit 12	Bit 11	Bit 10	Bit 9	Bit 8
0x002A	TPM1C1VL	Bit 7	Bit 6	Bit 5	Bit 4	Bit 3	Bit 2	Bit 1	Bit 0
0x002B	TPM1C2SC	CH2F	CH2IE	MS2B	MS2A	ELS2B	ELS2A	0	0
0x002C	TPM1C2VH	Bit 15	Bit 14	Bit 13	Bit 12	Bit 11	Bit 10	Bit 9	Bit 8
0x002D	TPM1C2VL	Bit 7	Bit 6	Bit 5	Bit 4	Bit 3	Bit 2	Bit 1	Bit 0
0x002E	TPM1C3SC	CH3F	CH3IE	MS3B	MS3A	ELS3B	ELS3A	—	—
0x002F	TPM1C3VH	Bit 15	Bit 14	Bit 13	Bit 12	Bit 11	Bit 10	Bit 9	Bit 8
0x0030	TPM1C3VL	Bit 7	Bit 6	Bit 5	Bit 4	Bit 3	Bit 2	Bit 1	Bit 0
0x0031– 0x0037	Reserved	—	—	—	—	—	—	—	—
0x0038	PTAD	PTAD7	PTAD6	PTAD5	PTAD4	PTAD3	PTAD2	PTAD1	PTAD0
0x0039	PTADD	PTADD7	PTADD6	—	—	PTADD3	PTADD2	PTADD1	PTADD0
0x003A	PTBD	PTBD7	PTBD6	PTBD5	PTBD4	PTBD3	PTBD2	PTBD1	PTBD0
0x003B	PTBDD	PTBDD7	PTBDD6	PTBDD5	PTBDD4	PTBDD3	PTBDD2	PTBDD1	PTBDD0
0x003C	PTCD	PTCD7	PTCD6	PTCD5	PTCD4	PTCD3	PTCD2	PTCD1	PTCD0
0x003D	PTCDD	PTCDD7	PTCDD6	PTCDD5	PTCDD4	PTCDD3	PTCDD2	PTCDD1	PTCDD0
0x003E	PTDD	—	—	PTDD5	PTDD4	PTDD3	PTDD2	PTDD1	PTDD0
0x003F	PTDDD	—	—	PTDDD5	PTDDD4	PTDDD3	PTDDD2	PTDDD1	PTDDD0

High-page registers, shown in [Table 4-3](#), are accessed much less often than other I/O and control registers, so they have been located outside the direct-addressable memory space, starting at 0x1800.

**Table 4-3. High-Page Register Summary (Sheet 1 of 3)**

Address	Register Name	Bit 7	6	5	4	3	2	1	Bit 0
0x1800	SRS	POR	PIN	COP	ILOP	ILAD	0	LVD	—
0x1801	SBD FR	0	0	0	0	0	0	0	BDFR
0x1802	SOPT1	COPT		STOPE	TCLKPEN	0	0	BKGDPE	RSTPE
0x1803	SOPT2	COPCLKS	COPW	0	0	0	0	0	0
0x1804– 0x1805	Reserved	—	—	—	—	—	—	—	—
0x1806	SDIDH	—	—	—	—	ID11	ID10	ID9	ID8
0x1807	SDIDL	ID7	ID6	ID5	ID4	ID3	ID2	ID1	ID0
0x1808	Reserved	—	—	—	—	—	—	—	—
0x1809	SPMSC1	LVWF	LVWACK	LVWIE	LVDRE	LVDSE	LVDE	0	BGBE
0x180A	SPMSC2	0	0	LVDV	LVWV	PPDF	PPDACK	0	PPDC

Table 4-3. High-Page Register Summary (Sheet 2 of 3) (continued)

Address	Register Name	Bit 7	6	5	4	3	2	1	Bit 0
0x180B– 0x180F	Reserved	—	—	—	—	—	—	—	—
0x1810	DBGCAH	Bit 15	14	13	12	11	10	9	Bit 8
0x1811	DBGCAL	Bit 7	6	5	4	3	2	1	Bit 0
0x1812	DBGCBH	Bit 15	14	13	12	11	10	9	Bit 8
0x1813	DBGCBL	Bit 7	6	5	4	3	2	1	Bit 0
0x1814	DBGFHH	Bit 15	14	13	12	11	10	9	Bit 8
0x1815	DBGFL	Bit 7	6	5	4	3	2	1	Bit 0
0x1816	DBGCC	DBGGEN	ARM	TAG	BRKEN	RWA	RWAEN	RWB	RWBEN
0x1817	DBGTT	TRGSEL	BEGIN	0	0	TRG3	TRG2	TRG1	TRG0
0x1818	DBGSS	AF	BF	ARMF	0	CNT3	CNT2	CNT1	CNT0
0x1819– 0x181F	Reserved	—	—	—	—	—	—	—	—
0x1820	FCDIV	DIVLD	PRDIV8	DIV5	DIV4	DIV3	DIV2	DIV1	DIV0
0x1821	FOPT	KEYEN	FNORED	0	0	0	0	SEC01	SEC00
0x1822	Reserved	—	—	—	—	—	—	—	—
0x1823	FCNFG	0	0	KEYACC	0	0	0	0	0
0x1824	FPROT	FPS7	FPS6	FPS5	FPS4	FPS3	FPS2	FPS1	0
0x1825	FSTAT	FCBEF	FCCF	FPVIOL	FACCERR	0	FBLANK	0	0
0x1826	FCMD	FCMD7	FCMD6	FCMD5	FCMD4	FCMD3	FCMD2	FCMD1	FCMD0
0x1827– 0x183F	Reserved	—	—	—	—	—	—	—	—
0x1840	PTAPE	PTAPE7	PTAPE6	PTAPE5	—	PTAPE3	PTAPE2	PTAPE1	PTAPE0
0x1841	PTASE	PTASE7	PTASE6	—	PTASE4	PTASE3	PTASE2	PTASE1	PTASE0
0x1842	PTADS	PTADS7	PTADS6	—	PTADS4	PTADS3	PTADS2	PTADS1	PTADS0
0x1843	Reserved	—	—	—	—	—	—	—	—
0x1844	PTBPE	PTBPE7	PTBPE6	PTBPE5	PTBPE4	PTBPE3	PTBPE2	PTBPE1	PTBPE0
0x1845	PTBSE	PTBSE7	PTBSE6	PTBSE5	PTBSE4	PTBSE3	PTBSE2	PTBSE1	PTBSE0
0x1846	PTBDS	PTBDS7	PTBDS6	PTBDS5	PTBDS4	PTBDS3	PTBDS2	PTBDS1	PTBDS0
0x1847	Reserved	—	—	—	—	—	—	—	—
0x1848	PTCPE	PTCPE7	PTCPE6	PTCPE5	PTCPE4	PTCPE3	PTCPE2	PTCPE1	PTCPE0
0x1849	PTCSE	PTCSE7	PTCSE6	PTCSE5	PTCSE4	PTCSE3	PTCSE2	PTCSE1	PTCSE0
0x184A	PTCDS	PTCDS7	PTCDS6	PTCDS5	PTCDS4	PTCDS3	PTCDS2	PTCDS1	PTCDS0
0x184B	Reserved	—	—	—	—	—	—	—	—
0x184C	PTDPE	—	—	PTDPE5	PTDPE4	PTDPE3	PTDPE2	PTDPE1	PTDPE0
0x184D	PTDSE	—	—	PTDSE5	PTDSE4	PTDSE3	PTDSE2	PTDSE1	PTDSE0
0x184E	PTDDS	—	—	PTDDS5	PTDDS4	PTDDS3	PTDDS2	PTDDS1	PTDDS0
0x184F	Reserved	—	—	—	—	—	—	—	—
0x1850	SCIBDH	LBKDIE	RXEDGIE	0	SBR12	SBR11	SBR10	SBR9	SBR8
0x1851	SCIBDL	SBR7	SBR6	SBR5	SBR4	SBR3	SBR2	SBR1	SBR0
0x1852	SCIC1	LOOPS	SCISWAI	RSRC	M	WAKE	ILT	PE	PT
0x1853	SCIC2	TIE	TCIE	RIE	ILIE	TE	RE	RWU	SBK
0x1854	SCIS1	TDRE	TC	RDRF	IDLE	OR	NF	FE	PF



Table 4-3. High-Page Register Summary (Sheet 3 of 3) (continued)

Address	Register Name	Bit 7	6	5	4	3	2	1	Bit 0
0x1855	SCIS2	LBKDIF	RXEDGIF	0	RXINV	RWUID	BRK13	LBKDE	RAF
0x1856	SCIC3	R8	T8	TXDIR	TXINV	ORIE	NEIE	FEIE	PEIE
0x1857	SCID	R7	R6	R5	R4	R3	R2	R1	R0
		T7	T6	T5	T4	T3	T2	T1	T0
0x1858	ICSC1	CLKS		RDIV			IREFS	IRCLKEN	IREFSTEN
0x1859	ICSC2	BDIV		RANGE	HGO	LP	EREFS	ERCLKEN	EREFTEN
0x185A	ICSTRM	TRIM							
0x185B	ICSSC	DRST		DMX32	IREFST	CLKST		OSCINIT	FTRIM
		DRS							
0x185C– 0x185F	Reserved	—	—	—	—	—	—	—	—
0x1860	MTIMSC	TOF	TOIE	TRST	TSTP	0	0	0	0
0x1861	MTIMCLK	0	0	CLKS			PS		
0x1862	MTIMCNTH	CNTH							
0x1863	MTIMCNTL	CNTL							
0x1864	MTIMMODH	MODH							
0x1865	MTIMMODL	MODL							
0x1866– 0x1877	Reserved	—	—	—	—	—	—	—	—
0x1878	ILRS0	ILR3		ILR2		ILR1		ILR0	
0x1879	ILRS1	ILR7		ILR6		ILR5		ILR4	
0x187A	ILRS2	ILR11		ILR10		ILR9		ILR8	
0x187B	ILRS3	ILR15		ILR14		ILR13		ILR12	
0x187C	ILRS4	ILR19		ILR18		ILR17		ILR16	
0x187D	ILRS5	ILR23		ILR22		ILR21		ILR20	
0x187E	ILRS6	ILR27		ILR26		ILR25		ILR24	
0x187F	ILRS7	ILR31		ILR30		ILR29		ILR28	

Several reserved flash memory locations, shown in [Table 4-4](#), are used for storing values used by several registers. These registers include an 8-byte backdoor key, NVBACKKEY, which can be used to gain access to secure memory resources. During reset events, the contents of NVPROT and NVOPT in the reserved flash memory are transferred into corresponding FPROT and FOPT registers in the high-page registers area to control security and block protection options.

**Table 4-4. Reserved Flash Memory Addresses**

Address	Register Name	Bit 7	6	5	4	3	2	1	Bit 0	
0xFFAE	NV_FTRIM	—	—	—	—	—	—	—	FTRIM	
0xFFAF	NV_ICSTRM	TRIM								
0xFFB0– 0xFFB7	NVBACKKEY	8-Byte Comparison Key								
0xFFB8– 0xFFBC	Reserved	—	—	—	—	—	—	—	—	
0xFFBD	NVPROT	FPS								0
0xFFBE	Reserved	—	—	—	—	—	—	—	—	
0xFFBF	NVOPT	KEYEN	FNORED	0	0	0	0	SEC01	SEC00	

Provided the key enable (KEYEN) bit is 1, the 8-byte comparison key can be used to temporarily disengage memory security. This key mechanism can be accessed only through user code running in secure memory. (A security key cannot be entered directly through background debug commands.) This security key can be disabled completely by programming the KEYEN bit to 0. If the security key is disabled, the only way to disengage security is by mass erasing the flash if needed (normally through the background debug interface) and verifying that flash is blank. To avoid returning to secure mode after the next reset, program the security bits (SEC) to the unsecured state (1:0).

### 4.3 RAM (System RAM)

The MC9S08FL16 series include static RAM. The locations in RAM below 0x0100 can be accessed using the more efficient direct addressing mode. Any single bit in this area can be accessed with the bit manipulation instructions (BCLR, BSET, BRCLR, and BRSET).

The RAM retains data when the MCU is in low-power wait, stop2, or stop3 mode. At power-on, the contents of RAM are uninitialized. RAM data is unaffected by any reset provided that the supply voltage does not drop below the minimum value for RAM retention.

For compatibility with older M68HC05 MCUs, the HCS08 resets the stack pointer to 0x00FF. In the MC9S08FL16 series, it is best to re-initialize the stack pointer to the top of the RAM so that the direct-page RAM can be used for frequently accessed RAM variables and bit-addressable program variables. Include the following 2-instruction sequence in your reset initialization routine (where RamLast is equated to the highest address of the RAM in the Freescale-provided equate file).

---

```
LDHX    #RamLast+1    ;point one past RAM
TXS                    ;SP<-(H:X-1)
```

---

When security is enabled, the RAM is considered a secure memory resource and is not accessible through BDM or code executing from non-secure memory. See [Section 4.5, “Security”](#) for a detailed description of the security feature.

## 4.4 Flash

The flash memory is intended primarily for program storage. In-circuit programming allows the operating program to be loaded into the flash memory after final assembly of the application product. It is possible to program the entire array through the single-wire background debug interface. Because no special voltages are needed for flash erase and programming operations, in-application programming is also possible through other software-controlled communication paths. For a more detailed discussion of in-circuit and in-application programming, refer to the *HCS08 Family Reference Manual, Volume I*, Freescale Semiconductor document order number HCS08RMv1.

### 4.4.1 Features

Features of the flash memory include:

- flash size
  - MC9S08FL16 — 16,384 bytes (32 pages of 512 bytes each)
  - MC9S08FL8 — 8,192 bytes (16 pages of 512 bytes each)
- Single power supply program and erase
- Command interface for fast program and erase operation
- Up to 100,000 program/erase cycles at typical voltage and temperature
- Flexible block protection
- Security feature for flash and RAM
- Auto power-down for low-frequency read accesses

### 4.4.2 Program and Erase Times

Before any program or erase command can be accepted, the flash clock divider register (FCDIV) must be written to set the internal clock for the flash module to a frequency ( $f_{\text{FCLK}}$ ) between 150 kHz and 200 kHz (see [Section 4.6.1, “Flash Clock Divider Register \(FCDIV\)”](#)). This register can be written only once, so it normally occurs during reset initialization. FCDIV cannot be written if the access error flag, FACCERR in FSTAT, is set. The user must ensure that FACCERR is not set before writing to the FCDIV register. One period of the resulting clock ( $1/f_{\text{FCLK}}$ ) is used by the command processor to time program and erase pulses. An integer number of these timing pulses are used by the command processor to complete a program or erase command.

[Table 4-5](#) shows program and erase times. The bus clock frequency and FCDIV determine the frequency of FCLK ( $f_{\text{FCLK}}$ ). The time for one cycle of FCLK is  $t_{\text{FCLK}} = 1/f_{\text{FCLK}}$ . The times are shown as a number of cycles of FCLK and as an absolute time for the case where  $t_{\text{FCLK}} = 5 \mu\text{s}$ . Program and erase times shown include overhead for the command state machine and enabling and disabling of program and erase voltages.

**Table 4-5. Program and Erase Times**

Parameter	Cycles of FCLK	Time if FCLK = 200 kHz
Byte program	9	45 $\mu$ s
Byte program (burst)	4	20 $\mu$ s <sup>1</sup>
Page erase	4000	20 ms
Mass erase	20,000	100 ms

<sup>1</sup> Excluding start/end overhead

### 4.4.3 Program and Erase Command Execution

The FCDIV register must be initialized and any error flags cleared before beginning command execution. The command execution steps are:

1. Write a data value to an address in the flash array. The address and data information from this write is latched into the flash interface. This write is a required first step in any command sequence. For erase and blank check commands, the value of the data is not important. For page erase commands, the address may be any address in the 512 byte page of flash to be erased. For mass erase and blank check commands, the address can be any address in the flash memory. Whole pages of 512 bytes are the smallest block of flash that may be erased. In the 4 KB version, there are two instances where the size of a block that is accessible to the user is less than 512 bytes: the first page following RAM, and the first page following the high page registers. These pages are overlapped by the RAM and high-page registers respectively.

#### NOTE

Do not program any byte in the flash more than once after a successful erase operation. Reprogramming bits to a byte which is already programmed is not allowed without first erasing the page in which the byte resides or mass erasing the entire flash memory. Programming without first erasing may disturb data stored in the flash.

2. Write the command code for the desired command to FCMD. The five valid commands are blank check (0x05), byte program (0x20), burst program (0x25), page erase (0x40), and mass erase (0x41). The command code is latched into the command buffer.
3. Write a 1 to the FCBEF bit in FSTAT to clear FCBEF and launch the command (including its address and data information).

A partial command sequence can be aborted manually by writing a 0 to FCBEF any time after the write to the memory array and before writing the 1 that clears FCBEF and launches the complete command. Aborting a command in this way sets the FACCERR access error flag which must be cleared before starting a new command.

A strictly monitored procedure must be obeyed or the command will not be accepted. This minimizes the possibility of any unintended changes to the flash memory contents. The command complete flag (FCCF) indicates when a command is complete. The command sequence must be completed by clearing FCBEF to launch the command. [Figure 4-2](#) is a flowchart for executing all of the commands except for burst

programming. The FCDIV register must be initialized before using any flash commands. This must be done only once following a reset.

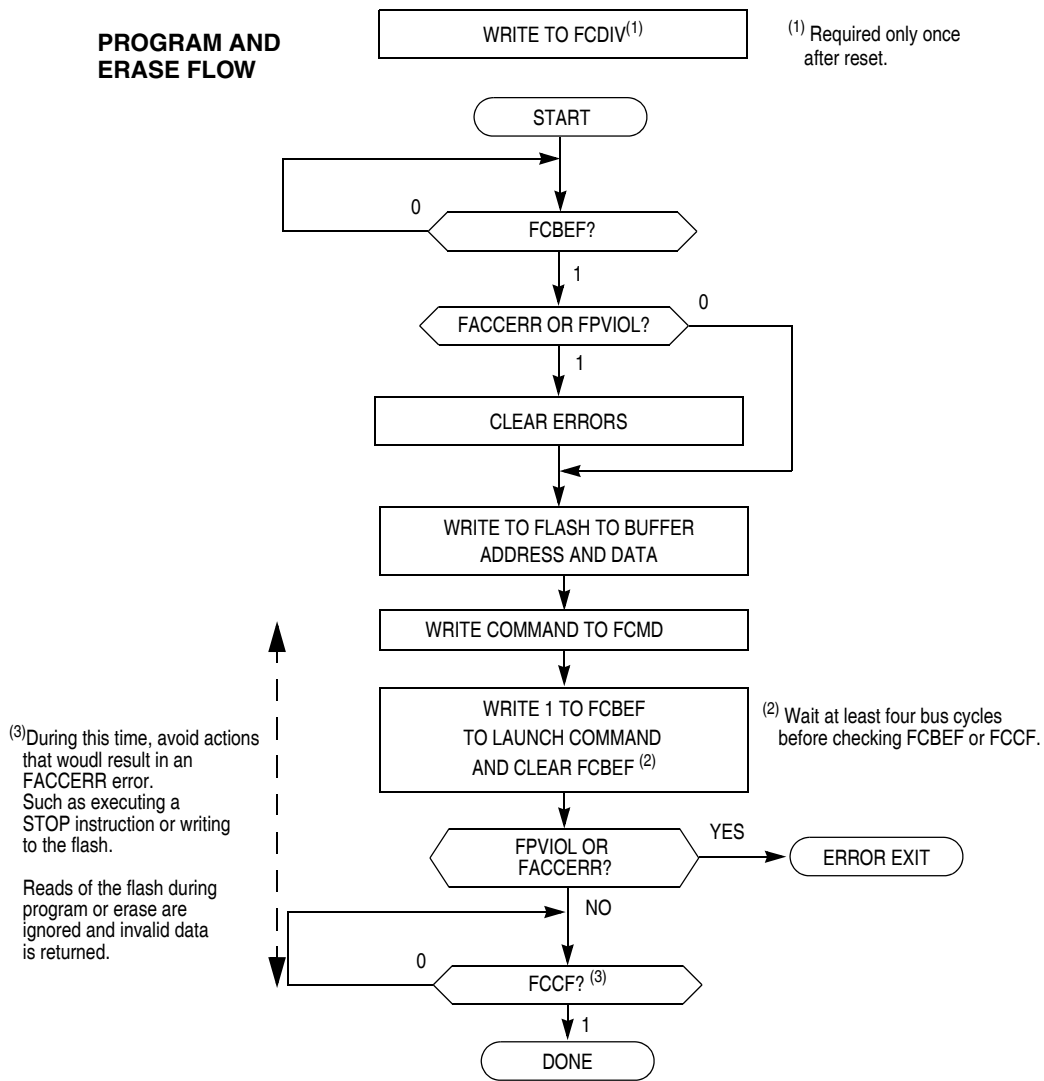

Figure 4-2. Flash Program and Erase Flowchart

### 4.4.4 Burst Program Execution

The burst program command is used to program sequential bytes of data in less time than would be required using the standard program command. This is possible because the high voltage to the flash array does not need to be disabled between program operations. Ordinarily, when a program or erase command is issued, an internal charge pump associated with the flash memory must be enabled to supply high voltage to the array. Upon completion of the command, the charge pump is turned off. When a burst program command is issued, the charge pump is enabled and then remains so after completion of the burst program operation if these two conditions are met:

- The next burst program command has been queued before the current program operation has completed.

- The next sequential address selects a byte on the same physical row as the current byte being programmed. A row of flash memory consists of 64 bytes. A byte within a row is selected by addresses A5 through A0. A new row begins when addresses A5 through A0 are all zero.

The first byte of a series of sequential bytes being programmed in burst mode will take the same amount of time to program as a byte programmed in standard mode. Subsequent bytes will program in the burst program time provided that the conditions above are met. If the next sequential address is the beginning of a new row, the program time for that byte will be the standard time instead of the burst time. This is because the high voltage of the array must be disabled and then enabled again. If a new burst command has not been queued before the current command finishes, then the charge pump will be disabled and high voltage removed from the array.

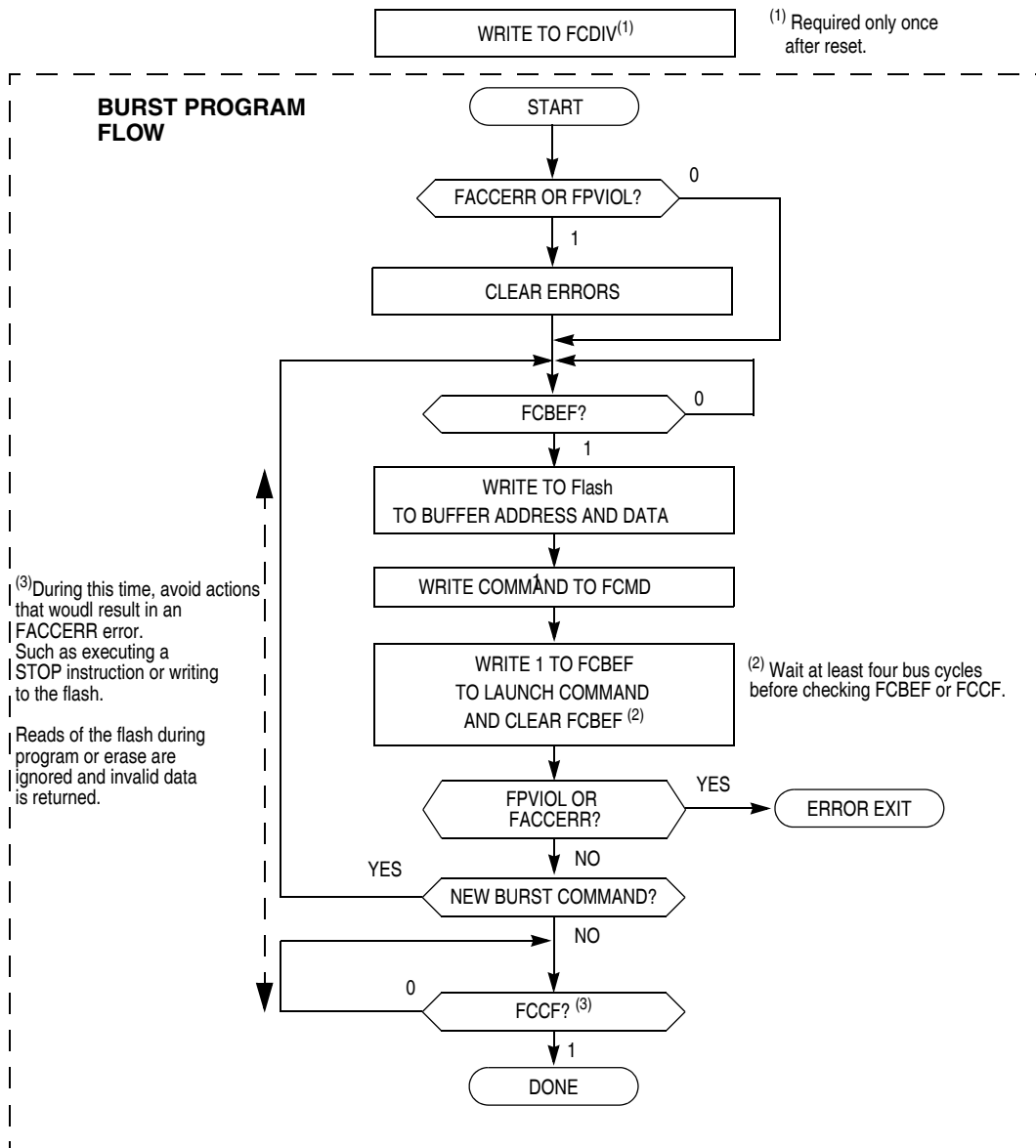

Figure 4-3. Flash Burst Program Flowchart

### 4.4.5 Access Errors

An access error occurs when the command execution protocol is violated.

Any of the following actions will set the access error flag (FACCERR) in FSTAT. FACCERR must be cleared by writing a 1 to FACCERR in FSTAT before any command can be processed.

- Writing to a flash address before the internal flash clock frequency has been set by writing to the FCDIV register
- Writing to a flash address while FCBEF is not set (A new command cannot be started until the command buffer is empty.)
- Writing a second time to a flash address before launching the previous command (There is only one write to flash for every command.)
- Writing a second time to FCMD before launching the previous command (There is only one write to FCMD for every command.)
- Writing to any flash control register other than FCMD after writing to a flash address
- Writing any command code other than the five allowed codes (0x05, 0x20, 0x25, 0x40, or 0x41) to FCMD
- Accessing (read or write) any flash control register other than the write to FSTAT (to clear FCBEF and launch the command) after writing the command to FCMD
- The MCU enters stop mode while a program or erase command is in progress (The command is aborted.)
- Writing the byte program, burst program, or page erase command code (0x20, 0x25, or 0x40) with a background debug command while the MCU is secured. (the background debug controller can only do blank check and mass erase commands when the MCU is secure.)
- Writing 0 to FCBEF to cancel a partial command

### 4.4.6 Flash Block Protection

The block protection feature prevents the protected region of flash from program or erase changes. Block protection is controlled through the flash protection register (FPROT). When enabled, block protection begins at any 512 byte boundary below the last address of flash, 0xFFFF. (see [Section 4.6.4, “Flash Protection Register \(FPROT and NVPROT\)”](#))

After exit from reset, FPROT is loaded with the contents of the NVPROT location which is in the nonvolatile register block of the flash memory. FPROT cannot be changed directly from application software so a runaway program cannot alter the block protection settings. Since NVPROT is the last 512 bytes of flash, if any amount of memory is protected, NVPROT is protected and cannot be altered (intentionally or unintentionally) by the application software. FPROT can be written through background debug commands which allows a protected flash memory to be erased and reprogrammed.

The block protection mechanism is illustrated below. The FPS bits are used as the upper bits of the last address of unprotected memory. This address is formed by concatenating FPS7:FPS1 with logic 1 bits as shown. For example, in order to protect the last 8192 bytes of memory (addresses 0xE000 through 0xFFFF), the FPS bits must be set to 1101 111 which makes the value 0xDFFF the last address of unprotected memory. In addition to programming the FPS bits to the appropriate value, FPDIS (bit 0 of

NVPROT) must be programmed to logic 0 to enable block protection. Therefore the value 0xDE must be programmed into NVPROT to protect addresses 0xE000 through 0xFFFF.

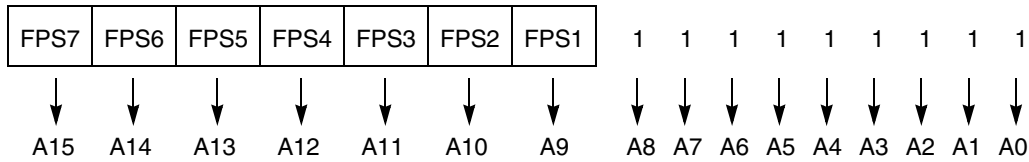

Figure 4-4. Block Protection Mechanism

One use for block protection is to block protect an area of flash memory for a bootloader program. This bootloader program can then be used to erase the rest of the flash memory and reprogram it. Because the bootloader is protected, it remains intact even if MCU power is lost in the middle of an erase and reprogram operation.

### 4.4.7 Vector Redirection

When block protection is enabled, the reset and interrupt vectors will be protected. Vector redirection allows users to modify interrupt vector information without unprotecting the bootloader and reset vector space. Vector redirection is enabled by programming the FNORED bit in the NVOPT register located at address 0xFFBF to zero. For redirection to occur, at least some portion - but not all - of the flash memory must be block protected by programming the NVPROT register located at address 0xFFBD. All of the interrupt vectors (memory locations 0xFFC0–0xFFFD) are redirected, though the reset vector (0xFFFE:FFFF) is not.

For example, if 512 bytes of flash are protected, the protected address region is from 0xFE00 through 0xFFFF. The interrupt vectors (0xFFC0–0xFFFD) are redirected to the locations 0xFDC0–0xFDFD. If a TPM1 overflow interrupt is taken, for instance, the values in the locations 0xFDE0:FDE1 are used for the vector instead of the values in the locations 0xFFE0:FFE1. This allows the user to reprogram the unprotected portion of the flash with new program code including new interrupt vector values while leaving the protected area, which includes the default vector locations, unchanged.

## 4.5 Security

The MC9S08FL16 series include circuitry that prevents unauthorized access to the contents of flash and RAM memory. When security is engaged, flash and RAM are considered secure resources. Direct-page registers, high-page registers, and the background debug controller are considered unsecured resources. Programs executing within secure memory have normal access to any MCU memory locations and resources. Attempts to access a secure memory location with a program executing from an unsecured memory space or through the background debug interface are blocked (writes are ignored and reads return all 0s).

Security is engaged or disengaged based on the state of two nonvolatile register bits (SEC01:SEC00) in the FOPT register. During reset, the contents of the nonvolatile location NVOPT are copied from flash into the working FOPT register in high-page register space. A user engages security by programming the NVOPT location, which can be done at the same time the flash memory is programmed. The 1:0 state disengages security and the other three combinations engage security. Notice the erased state (1:1) makes



the MCU secure. When the flash is erased during development, you should immediately program the SEC00 bit to 0 in NVOPT so SEC01:SEC00 = 1:0. This allows the MCU to remain unsecured after a subsequent reset.

The on-chip debug module cannot be enabled while the MCU is secure. The separate background debug controller can still be used for background memory access commands, but the MCU cannot enter active background mode except by holding BKGD/MS low at the rising edge of reset.

A user can choose to allow or disallow a security unlocking mechanism through an 8-byte backdoor security key. If the nonvolatile KEYEN bit in NVOPT/FOPT is 0, the backdoor key is disabled and there is no way to disengage security without completely erasing all flash locations. If KEYEN is 1, a secure user program can temporarily disengage security by:

1. Writing 1 to KEYACC in the FCNFG register. This makes the flash module interpret writes to the backdoor comparison key locations (NVBACKKEY through NVBACKKEY+7) as values to be compared against the key rather than as the first step in a flash program or erase command.
2. Writing the user-entered key values to the NVBACKKEY through NVBACKKEY+7 locations. These writes must occur in order, starting with the value for NVBACKKEY and ending with NVBACKKEY+7. STHX should not be used for these writes because they cannot be performed on adjacent bus cycles. User software normally gets the key codes from outside the MCU system through a communication interface such as a serial I/O.
3. Writing 0 to KEYACC in the FCNFG register. If the 8-byte key that was just written matches the key stored in the flash locations, SEC01:SEC00 are automatically changed to 1:0 and security is disengaged until the next reset.

The security key can be written only from secure memory (either RAM or flash), so it cannot be entered through background commands without the cooperation of a secure user program.

The backdoor comparison key (NVBACKKEY through NVBACKKEY+7) is located in flash memory locations in the nonvolatile register space so users can program these locations exactly as they would program any other flash memory location. The nonvolatile registers are in the same 512-byte block of flash as the reset and interrupt vectors, so block protecting that space also block protects the backdoor comparison key. Block protects cannot be changed from user application programs, so if the vector space is block protected, the backdoor security key mechanism cannot permanently change the block protect, security settings, or the backdoor key.

Security can always be disengaged through the background debug interface by taking these steps:

1. Disabling any block protections by writing FPROT. FPROT can be written only with background debug commands, not from application software.
2. Mass erase flash if necessary.
3. Blank check flash. Provided flash is completely erased, security is disengaged until the next reset. To avoid returning to secure mode after the next reset, program NVOPT so SEC01:SEC00 = 1:0.

## 4.6 Flash Registers and Control Bits

The flash module has nine 8-bit registers in the high-page register space, three of which are in the nonvolatile register space in flash memory which are copied into three corresponding high-page control

registers at reset. There is also an 8-byte comparison key in flash memory. Refer to [Table 4-3](#) and [Table 4-4](#) for the absolute address assignments for all flash registers. This section refers to registers and control bits only by their names. A Freescale-provided equate or header file is normally used to translate these names into the appropriate absolute addresses.

### 4.6.1 Flash Clock Divider Register (FCDIV)

Bit 7 of this register is a read-only status flag. Bits 6 through 0 may be read at any time but can be written only once. Before any erase or programming operations are possible, write to this register to set the frequency of the clock for the nonvolatile memory system within acceptable limits.

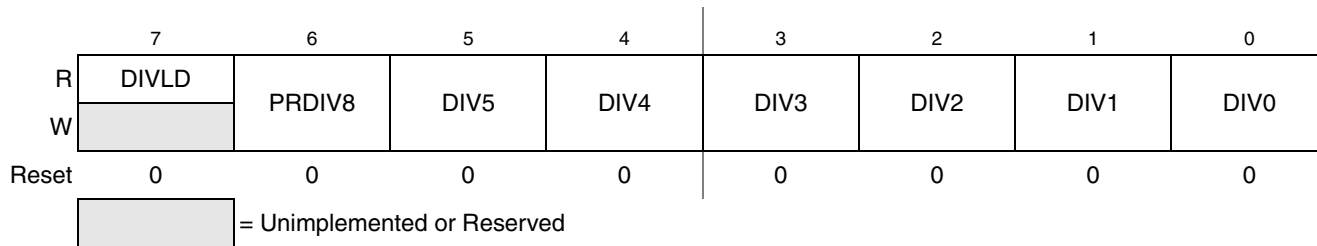

Figure 4-5. Flash Clock Divider Register (FCDIV)

Table 4-6. FCDIV Register Field Descriptions

Field	Description
7 DIVLD	<b>Divisor Loaded Status Flag</b> — When set, this read-only status flag indicates that the FCDIV register has been written since reset. Reset clears this bit and the first write to this register causes this bit to become set regardless of the data written. 0 FCDIV has not been written since reset; erase and program operations disabled for flash. 1 FCDIV has been written since reset; erase and program operations enabled for flash.
6 PRDIV8	<b>Prescale (Divide) Flash Clock by 8</b> 0 Clock input to the flash clock divider is the bus rate clock. 1 Clock input to the flash clock divider is the bus rate clock divided by 8.
5:0 DIV[5:0]	<b>Divisor for Flash Clock Divider</b> — The flash clock divider divides the bus rate clock (or the bus rate clock divided by 8 if PRDIV8 = 1) by the value in the 6-bit DIV5:DIV0 field plus one. The resulting frequency of the internal flash clock must fall within the range of 200 kHz to 150 kHz for proper flash operations. Program/Erase timing pulses are one cycle of this internal flash clock which corresponds to a range of 5 μs to 6.7 μs. The automated programming logic uses an integer number of these pulses to complete an erase or program operation. See <a href="#">Equation 4-1</a> , <a href="#">Equation 4-2</a> , and <a href="#">Table 4-6</a> .

$$\text{if PRDIV8} = 0, f_{\text{FLK}} = f_{\text{Bus}} \div ([\text{DIV5:DIV0}] + 1) \tag{Eqn. 4-1}$$

$$\text{if PRDIV8} = 1, f_{\text{FLK}} = f_{\text{Bus}} \div (8 \times ([\text{DIV5:DIV0}] + 1)) \tag{Eqn. 4-2}$$

[Table 4-7](#) shows the appropriate values for PRDIV8 and DIV5:DIV0 for selected bus frequencies.

**Table 4-7. Flash Clock Divider Settings**

$f_{Bus}$	PRDIV8 (Binary)	DIV5:DIV0 (Decimal)	$f_{CLK}$	Program/Erase Timing Pulse (5 $\mu$ s Min, 6.7 $\mu$ s Max)
10 MHz	0	49	200 kHz	5 $\mu$ s
8 MHz	0	39	200 kHz	5 $\mu$ s
4 MHz	0	19	200 kHz	5 $\mu$ s
2 MHz	0	9	200 kHz	5 $\mu$ s
1 MHz	0	4	200 kHz	5 $\mu$ s
200 kHz	0	0	200 kHz	5 $\mu$ s
150 kHz	0	0	150 kHz	6.7 $\mu$ s

## 4.6.2 Flash Options Register (FOPT and NVOPT)

During reset, the contents of the nonvolatile location NVOPT are copied from flash into FOPT. Bits 5 through 2 are not used and always read 0. This register may be read at any time, but writes have no meaning or effect. To change the value in this register, erase and reprogram the NVOPT location in flash memory as usual and issue a new MCU reset.

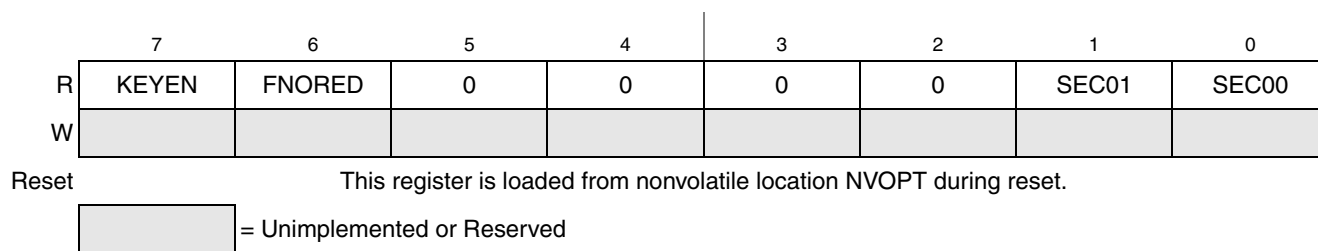
**Figure 4-6. Flash Options Register (FOPT)**
**Table 4-8. FOPT Register Field Descriptions**

Field	Description
7 KEYEN	<b>Backdoor Key Mechanism Enable</b> — When this bit is 0, the backdoor key mechanism cannot be used to disengage security. The backdoor key mechanism is accessible only from user (secured) firmware. BDM commands cannot be used to write key comparison values that would unlock the backdoor key. For more detailed information about the backdoor key mechanism, refer to <a href="#">Section 4.5, “Security.”</a> 0 No backdoor key access allowed. 1 If user firmware writes an 8-byte value that matches the nonvolatile backdoor key (NVBACKKEY through NVBACKKEY+7 in that order), security is temporarily disengaged until the next MCU reset.
6 FNORED	<b>Vector Redirection Disable</b> — When this bit is 1, then vector redirection is disabled. 0 Vector redirection enabled. 1 Vector redirection disabled.
1:0 SEC0[1:0]	<b>Security State Code</b> — This 2-bit field determines the security state of the MCU as shown in <a href="#">Table 4-9</a> . When the MCU is secure, the contents of RAM and flash memory cannot be accessed by instructions from any unsecured source including the background debug interface. For more detailed information about security, refer to <a href="#">Section 4.5, “Security.”</a>

**Table 4-9. Security States**

SEC01:SEC00	Description
0:0	secure
0:1	secure
1:0	unsecured
1:1	secure

SEC01:SEC00 changes to 1:0 after successful backdoor key entry or a successful blank check of flash.

### 4.6.3 Flash Configuration Register (FCNFG)

Bits 5 can be read or written at any time. Bits 7, 6 and 4 through 0 always read 0 and cannot be written.

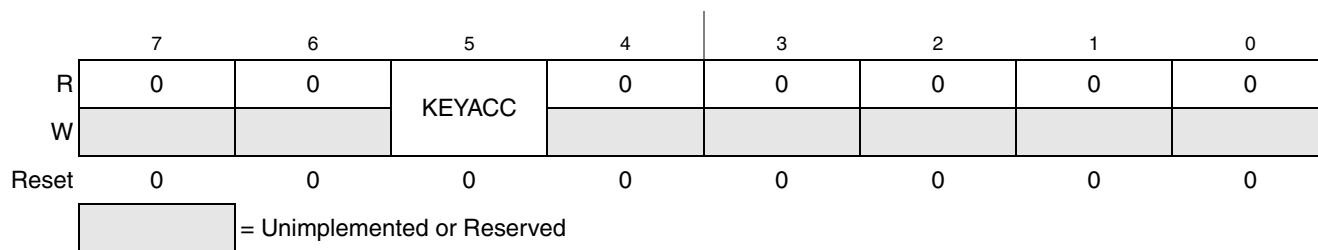

**Figure 4-7. Flash Configuration Register (FCNFG)**

**Table 4-10. FCNFG Register Field Descriptions**

Field	Description
5 KEYACC	<b>Enable Writing of Access Key</b> — This bit enables writing of the backdoor comparison key. For more detailed information about the backdoor key mechanism, refer to <a href="#">Section 4.5, “Security.”</a> 0 Writes to 0xFFB0–0xFFB7 are interpreted as the start of a flash programming or erase command. 1 Writes to NVBACKKEY (0xFFB0–0xFFB7) are interpreted as comparison key writes.

### 4.6.4 Flash Protection Register (FPROT and NVPROT)

During reset, the contents of the nonvolatile location NVPROT are copied from flash into FPROT. Bits 0 is not used and always reads as 0. This register may be read at any time, but user program writes have no meaning or effect. Background debug commands can write to FPROT.

	7	6	5	4	3	2	1	0
R	FPS7	FPS6	FPS5	FPS4	FPS3	FPS2	FPS1	0
W	(1)	(1)	(1)	(1)	(1)	(1)	(1)	

Reset This register is loaded from nonvolatile location NVPROT during reset.

<sup>1</sup> Background commands can be used to change the contents of these bits in FPROT.

Figure 4-8.

Table 4-11. FPROT Register Field Descriptions

Field	Description
7:1 FPS[7:1]	<b>Flash Protect Select Bits</b> — When FPDIS = 0, this 7-bit field determines the ending address of unprotected flash locations at the high address end of the flash. Protected flash locations cannot be erased or programmed.

### 4.6.5 Flash Status Register (FSTAT)

Bits 3, 1, and 0 always read 0 and writes have no meaning or effect. The remaining five bits are status bits that can be read at any time. Writes to these bits have special meanings that are discussed in the bit descriptions.

	7	6	5	4	3	2	1	0
R	FCBEF	FCCF	FPVIOL	FACCERR	0	FBLANK	0	0
W								
Reset	1	1	0	0	0	0	0	0

= Unimplemented or Reserved

Figure 4-9. Flash Status Register (FSTAT)

**Table 4-12. FSTAT Register Field Descriptions**

Field	Description
7 FCBEF	<p><b>Flash Command Buffer Empty Flag</b> — The FCBEF bit is used to launch commands. It also indicates that the command buffer is empty so that a new command sequence can be executed when performing burst programming. The FCBEF bit is cleared by writing a 1 to it or when a burst program command is transferred to the array for programming. Only burst program commands can be buffered.</p> <p>0 Command buffer is full (not ready for additional commands). 1 A new burst program command may be written to the command buffer.</p>
6 FCCF	<p><b>Flash Command Complete Flag</b> — FCCF is set automatically when the command buffer is empty and no command is being processed. FCCF is cleared automatically when a new command is started (by writing 1 to FCBEF to register a command). Writing to FCCF has no meaning or effect.</p> <p>0 Command in progress 1 All commands complete</p>
5 FPVIOL	<p><b>Protection Violation Flag</b> — FPVIOL is set automatically when FCBEF is cleared to register a command that attempts to erase or program a location in a protected block (the erroneous command is ignored). FPVIOL is cleared by writing a 1 to FPVIOL</p> <p>0 No protection violation. 1 An attempt was made to erase or program a protected location.</p>
4 FACCERR	<p><b>Access Error Flag</b> — FACCERR is set automatically when the proper command sequence is not obeyed exactly (the erroneous command is ignored), if a program or erase operation is attempted before the FCDIV register has been initialized, or if the MCU enters stop while a command was in progress. For a more detailed discussion of the exact actions that are considered access errors, see <a href="#">Section 4.5.5, “Access Errors.”</a> FACCERR is cleared by writing a 1 to FACCERR. Writing a 0 to FACCERR has no meaning or effect.</p> <p>0 No access error. 1 An access error has occurred.</p>
2 FBLANK	<p><b>Flash Verified as All Blank (erased) Flag</b> — FBLANK is set automatically at the conclusion of a blank check command if the entire flash array was verified as erased. FBLANK is cleared by clearing FCBEF to write a new valid command. Writing to FBLANK has no meaning or effect.</p> <p>0 After a blank check command is completed and FCCF = 1, FBLANK = 0 indicates the flash array is not completely erased. 1 After a blank check command is completed and FCCF = 1, FBLANK = 1 indicates the flash array is completely erased (all 0xFF).</p>

## 4.6.6 Flash Command Register (FCMD)

Only five command codes are recognized in normal user modes as shown in [Table 4-14](#). Refer to [Section 4.6.3, “Flash Configuration Register \(FCNFG\)”](#) for a detailed discussion of flash programming and erase operations.

	7	6	5	4	3	2	1	0
R	0	0	0	0	0	0	0	0
W	FCMD7	FCMD6	FCMD5	FCMD4	FCMD3	FCMD2	FCMD1	FCMD0
Reset	0	0	0	0	0	0	0	0

**Figure 4-10. Flash Command Register (FCMD)**

**Table 4-13. FCMD Register Field Descriptions**

Field	Description
FCMD[7:0]	<b>Flash Command Bits</b> — See <a href="#">Table 4-14</a>

**Table 4-14. Flash Commands**

Command	FCMD	Equate File Label
Blank check	0x05	mBlank
Byte program	0x20	mByteProg
Byte program — burst mode	0x25	mBurstProg
Page erase (512 bytes/page)	0x40	mPageErase
Mass erase (all flash)	0x41	mMassErase

All other command codes are illegal and generate an access error.

It is not necessary to perform a blank check command after a mass erase operation. Only blank check is required as part of the security unlocking mechanism.





# Chapter 5

## Resets, Interrupts, and System Configuration

### 5.1 Introduction

This chapter discusses basic reset and interrupt mechanisms and the various sources of reset and interrupts in the MC9S08FL16 series. Some interrupt sources from peripheral modules are discussed in great detail in other chapters of this reference manual. This chapter gathers basic information about all reset and interrupt sources in one place for easy reference. A few reset and interrupt sources, including the computer operating properly (COP) watchdog, are not part of on-chip peripheral systems with their own sections but are part of the system control logic.

### 5.2 Features

Reset and interrupt features include:

- Multiple sources of reset for flexible system configuration and reliable operation
- Reset status register (SRS) to indicate the source of the most recent reset
- Separate interrupt vectors for each module (reduces polling overhead) (see [Table 5-1](#))

### 5.3 MCU Reset

Resetting the MCU provides a way to start processing from a set of known initial conditions. During reset, most control and status registers are forced to initial values and the program counter is loaded from the reset vector (0xFFFF:0xFFFF). On-chip peripheral modules are disabled and I/O pins are initially configured as general-purpose high-impedance inputs with disabled pullup devices. The I bit in the condition code register (CCR) is set to block maskable interrupts so the user program has a chance to initialize the stack pointer (SP) and system control settings. SP is forced to 0x00FF at reset.

The MC9S08FL16 series have seven sources for reset:

- Power-on reset (POR)
- Low-voltage detect (LVD)
- Computer operating properly (COP) timer
- Illegal opcode detect (ILOP)
- Illegal address detect (ILAD)
- Background debug forced reset
- External reset pin ( $\overline{\text{RESET}}$ )

Each of these sources, with the exception of the background debug forced reset, has an associated bit in the system reset status (SRS) register.

## 5.4 Computer Operating Properly (COP) Watchdog

The COP watchdog forces a system reset when the application software fails to execute as expected. To prevent a system reset from the COP timer (when it is enabled), application software must reset the COP counter periodically. If the application program gets lost and fails to reset the COP counter before it times out, a system reset is generated to force the system back to a known starting point.

After any reset, the COP watchdog is enabled (see [Section 5.7.4, “System Options Register 1 \(SOPT1\),”](#) for additional information). If the COP watchdog is not used in an application, it can be disabled by clearing COPT bits in SOPT1.

The COP counter is reset by writing 0x55 and 0xAA (in this order) to the address of SRS during the selected timeout period. Writes do not affect the data in the read-only SRS. As soon as the write sequence is completed, the COP timeout period re-starts. If the program fails to do this during the time-out period, the MCU will reset. Also, if any value other than 0x55 or 0xAA is written to SRS, the MCU immediately resets.

The COPCLKS bit in SOPT2 (see [Section 5.7.5, “System Options Register 2 \(SOPT2\),”](#) for additional information) selects the clock source used for the COP timer. The clock source options are either the bus clock or an internal 1 kHz clock source. With each clock source, there are three associated time-outs controlled by the COPT bits in SOPT1. [Table 5-6](#) summarizes the control functions of the COPCLKS and COPT bits. The COP watchdog defaults to operation from the 1 kHz clock source and the longest time-out ( $2^{10}$  cycles).

When the bus clock source is selected, windowed COP operation is available by setting COPW in the SOPT2 register. In this mode, writes to the SRS register to clear the COP timer must occur in the last 25% of the selected timeout period. A premature write immediately resets the MCU. When the 1 kHz clock source is selected, windowed COP operation is not available.

The COP counter is initialized by the first writes to the SOPT1 and SOPT2 registers and after any system reset. Subsequent writes to SOPT1 and SOPT2 have no effect on COP operation. Even if the application uses the reset default settings of COPT, COPCLKS, and COPW bits, the user must write to the write-once SOPT1 and SOPT2 registers during reset initialization to lock in the settings. This prevents accidental changes if the application program gets lost.

The write to SRS that services (clears) the COP counter must not be placed in an interrupt service routine (ISR) because the ISR can continue executing periodically even if the main application program fails.

If the bus clock source is selected, the COP counter does not increment while the MCU is in background debug mode or while the system is in stop mode. The COP counter resumes when the MCU exits background debug mode or stop mode.

If the 1 kHz clock source is selected, the COP counter is re-initialized to zero upon entry to either background debug mode or stop mode and begins from zero upon exit from background debug mode or stop mode.

## 5.5 Interrupts

Interrupts save the current CPU status and registers, execute an interrupt service routine (ISR), and then restore the CPU status so processing resumes where it left off before the interrupt. Other than the software interrupt (SWI), which is a program instruction, interrupts are caused by hardware events such as an edge on the IRQ pin or a timer-overflow event. The debug module can also generate an SWI under certain circumstances.

If an event occurs in an enabled interrupt source, an associated read-only status flag will be set. The CPU will not respond until and unless the local interrupt enable is a logic 1. The I bit in the CCR is 0 to allow interrupts. The global interrupt mask (I bit) in the CCR is initially set after reset which masks (prevents) all maskable interrupt sources. The user program initializes the stack pointer and performs other system setup before clearing the I bit to allow the CPU to respond to interrupts.

When the CPU receives a qualified interrupt request, it completes the current instruction before responding to the interrupt. The interrupt sequence obeys the same cycle-by-cycle sequence as the SWI instruction and consists of:

- Saving the CPU registers on the stack
- Setting the I bit in the CCR to mask further interrupts
- Fetching the interrupt vector for the highest-priority interrupt that is currently pending
- Filling the instruction queue with the first three bytes of program information starting from the address fetched from the interrupt vector locations

While the CPU is responding to the interrupt, the I bit is automatically set to prevent another interrupt from interrupting the ISR itself (this is called nesting of interrupts). Normally, the I bit is restored to 0 when the CCR is restored from the value stacked on entry to the ISR. In rare cases, the I bit may be cleared inside an ISR (after clearing the status flag that generated the interrupt) so that other interrupts can be serviced without waiting for the first service routine to finish. This practice is recommended for only the most experienced programmers because it can lead to subtle program errors that are difficult to debug.

The interrupt service routine ends with a return-from-interrupt (RTI) instruction which restores the CCR, A, X, and PC registers to their pre-interrupt values by reading the previously saved information off the stack.

### NOTE

For compatibility with the M68HC08, the H register is not automatically saved and restored. Push H onto the stack at the start of the interrupt service routine (ISR) and restore it immediately before the RTI that is used to return from the ISR.

When two or more interrupts are pending when the I bit is cleared, the highest priority source is serviced first (see [Table 5-1](#)).

### 5.5.1 Interrupt Stack Frame

[Figure 5-1](#) shows the contents and organization of a stack frame. Before the interrupt, the stack pointer (SP) points at the next available byte location on the stack. The current values of CPU registers are stored

on the stack starting with the low-order byte of the program counter (PCL) and ending with the CCR. After stacking, the SP points at the next available location on the stack which is the address that is one less than the address where the CCR was saved. The PC value that is stacked is the address of the instruction in the main program that would have executed next if the interrupt had not occurred.

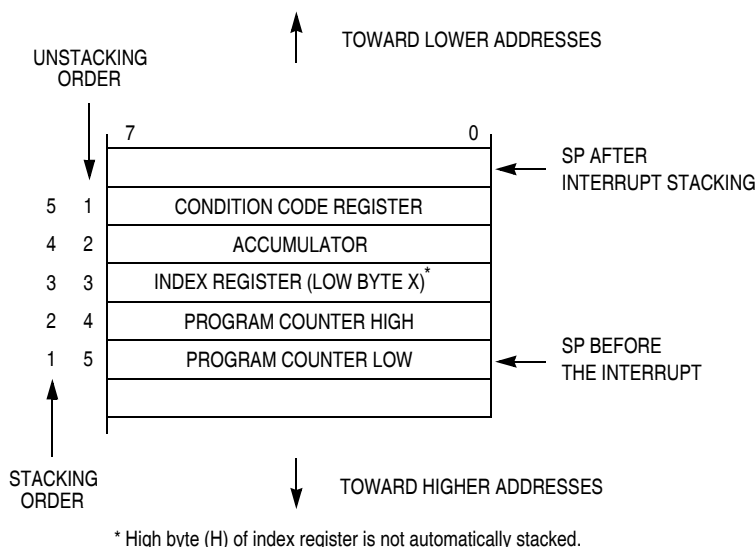

**Figure 5-1. Interrupt Stack Frame**

When an RTI instruction executes, these values are recovered from the stack in reverse order. As part of the RTI sequence, the CPU fills the instruction pipeline by reading three bytes of program information, starting from the PC address recovered from the stack.

The status flag causing the interrupt must be acknowledged (cleared) before returning from the ISR. Typically, the flag must be cleared at the beginning of the ISR so that if another interrupt is generated by this source, it will be registered so it can be serviced after completion of the current ISR.

## 5.5.2 External Interrupt Request (IRQ) Pin

External interrupts are managed by the IRQSC status and control register. When the IRQ function is enabled, synchronous logic monitors the pin for edge-only or edge-and-level events. When the MCU is in stop mode and system clocks are shut down, a separate asynchronous path is used so the IRQ (if enabled) can wake the MCU.

### 5.5.2.1 Pin Configuration Options

The IRQ pin enable (IRQPE) control bit in IRQSC must be 1 in order for the IRQ pin to act as the interrupt request (IRQ) input. The user can choose the polarity of edges or levels detected (IRQEDG), whether the pin detects edges-only or edges and levels (IRQMOD), or whether an event causes an interrupt or only sets the IRQF flag which can be polled by software.

When enabled, the IRQ pin, defaults to use an internal pull device (IRQPDD = 0). The device is a pullup or pulldown depending on the polarity chosen. If the user uses an external pullup or pulldown, the IRQPDD can be written to a 1 to turn off the internal device.

BIH and BIL instructions may be used to detect the level on the IRQ pin when it is configured to act as the IRQ input.

### NOTE

This pin does not contain a clamp diode to  $V_{DD}$  and must not be driven above  $V_{DD}$ . The voltage measured on the internally pulled up IRQ pin may be as low as  $V_{DD} - 0.7$  V. The internal gates connected to this pin are pulled all the way to  $V_{DD}$ .

When enabling the IRQ pin for use, the IRQF will be set, and must be cleared prior to enabling the interrupt. When configuring the pin for falling edge and level sensitivity in a 3V system, it is necessary to wait at least cycles between clearing the flag and enabling the interrupt.

### 5.5.2.2 Edge and Level Sensitivity

The IRQMOD control bit reconfigures the detection logic so it can detect edge events and pin levels. In this edge detection mode, the IRQF status flag is set when an edge is detected (when the IRQ pin changes from the deasserted to the asserted level), but the flag is continuously set (and cannot be cleared) as long as the IRQ pin remains at the asserted level.

### 5.5.3 Interrupt Vectors, Sources, and Local Masks

Table 5-1 provides a summary of all interrupt sources. Higher-priority sources are located toward the bottom of the table. The high-order byte of the address for the interrupt service routine is located at the first address in the vector address column, and the low-order byte of the address for the interrupt service routine is located at the next higher address.

When an interrupt condition occurs, an associated flag bit is set. If the associated local interrupt enable is 1, an interrupt request is sent to the CPU. If the global interrupt mask (I bit in the CCR) is 0, the CPU finishes the current instruction, stacks the PCL, PCH, X, A, and CCR CPU registers, sets the I bit, and then fetches the interrupt vector for the highest priority pending interrupt. Processing then continues in the interrupt service routine.

**Table 5-1. Vector Summary (from Lowest to Highest Priority)**

Vector Number	Address (High/Low)	Vector Name	Module	Source	Local Enable	Description
23 to 31	0xFFC0:FFC1 0xFFD0:FFD1	Unused vector space (available for user program)				
22	0xFFD2:FFD3	Vscitx	SCI	TRDE TC	TIE TCIE	SCI transmit
21	0xFFD4:FFD5	Vscirx	SCI	IDLE RDRF LBKDIF RXEDGIF	ILIE RIE LBKDIE RXEDGIE	SCI receive

**Table 5-1. Vector Summary (from Lowest to Highest Priority) (continued)**

Vector Number	Address (High/Low)	Vector Name	Module	Source	Local Enable	Description
20	0xFFD6:FFD7	Vscierr	SCI	OR NF FE PF	ORIE NEIE FEIE PEIE	SCI error
19	0xFFD8:FFD9	Unused	—	—	—	—
18	0xFFDA:FFDB	Unused	—	—	—	—
17	0xFFDC:FFDD	Vadc	ADC	COCO	AIEN	ADC
16	0xFFDE:FFDF	Vtpm2ovf	TPM2	TOF	TOIE	TPM2 overflow
15	0xFFE0:FFE1	Vtpm2ch1	TPM2CH1	CH1F	CH1IE	TPM2 channel 1
14	0xFFE2:FFE3	Vtpm2ch0	TPM2CH0	CH0F	CH0IE	TPM2 channel 0
13	0xFFE4:FFE5	Vtpm1ovf	TPM1	TOF	TOIE	TPM1 overflow
12	0xFFE6:FFE7	Unused	—	—	—	—
11	0xFFE8:FFE9	Unused	—	—	—	—
10	0xFFEA:FFEB	Vtpm1ch3	TPM1CH3	CH3F	CH3IE	TPM1 channel 3
9	0xFFEC:FFED	Vtpm1ch2	TPM1CH2	CH2F	CH2IE	TPM1 channel 2
8	0xFFEE:FFEF	Vtpm1ch1	TPM1CH1	CH1F	CH1IE	TPM1 channel 1
7	0xFFF0:FFF1	Vtpm1ch0	TPM1CH0	CH0F	CH0IE	TPM1 channel 0
6	0xFFF2:FFF3	Vmtim	MTIM16	TOF	TOIE	MTIM16 overflow interrupt
5	0xFFF4:FFF5	Unused	—	—	—	—
4	0xFFF6:FFF7	Unused	—	—	—	—
3	0xFFF8:FFF9	Vlvd	System control	LVWF	LVWIE	Low-voltage warning
2	0xFFFA:FFFB	Virq	IRQ	IRQF	IRQIE	IRQ pin
1	0xFFFC:FFFD	Vswi	Core	SWI Instruction	—	Software interrupt
0	0xFFFF:FFFF	Vreset	System control	COP LVD RESET pin Illegal opcode Illegal address POR BDFR	COPE LVDRE RSTPE — — —	Watchdog timer Low-voltage detect External pin Illegal opcode Illegal address Power-on-reset BDM force reset

## 5.6 Low-Voltage Detect (LVD) System

The MC9S08FL16 series include a system that protects against low voltage conditions to protect memory contents and control MCU system states during supply voltage variations. The system is comprised of a power-on reset (POR) circuit and an LVD circuit with a user selectable trip voltage, either high ( $V_{LVDH}$ ) or low ( $V_{LVDL}$ ). The LVD circuit is enabled when LVDE in SPMSC1 is high and the trip voltage is selected by LVDV in SPMSC2. The LVD is disabled upon entering any of the stop modes unless the LVDSE bit is set. If LVDSE and LVDE are both set, then the MCU cannot enter stop2 and the current consumption in stop3 with the LVD enabled will be greater.

## 5.6.1 Power-On Reset Operation

When power is initially applied to the MCU, or when the supply voltage drops below the  $V_{POR}$  level, the POR circuit puts the system into reset. As the supply voltage rises, the LVD circuit holds the chip in reset until the supply has risen above the  $V_{LVDL}$  level. Both the POR bit and the LVD bit in SRS are set following a POR.

## 5.6.2 LVD Reset Operation

The LVD can be configured to generate a reset upon detection of a low voltage condition by setting LVDRE to 1. After an LVD reset has occurred, the LVD system holds the MCU in reset until the supply voltage has risen above the level determined by LVDV. The LVD bit in the SRS register is set following either an LVD reset or POR.

## 5.6.3 Low-Voltage Warning (LVW) Interrupt Operation

The LVD system has a low voltage warning flag that indicates that the supply voltage is approaching, but still above, the LVD voltage. When a low voltage warning condition is detected and is configured for interrupt operation (LVWIE set to 1), LVWF in SPMSC1 is set and an LVW interrupt request occurs.

## 5.7 Reset, Interrupt, and System Control Registers and Control Bits

One 8-bit register in the direct page register space and eight 8-bit registers in the high-page register space are related to reset and interrupt systems.

Refer to the direct-page register summary in [Chapter 4, “Memory,”](#) of this data sheet for the absolute address assignments for all registers. This section refers to registers and control bits only by their names. A Freescale-provided equate or header file is used to translate these names into the appropriate absolute addresses.

Some control bits in the SOPT1 and SPMSC2 registers are related to modes of operation. Although brief descriptions of these bits are provided here, the related functions are discussed in greater detail in [Chapter 3, “Modes of Operation.”](#)

### 5.7.1 Interrupt Pin Request Status and Control Register (IRQSC)

This direct-page register includes status and control bits, which are used to configure the IRQ function, report status, and acknowledge IRQ events.

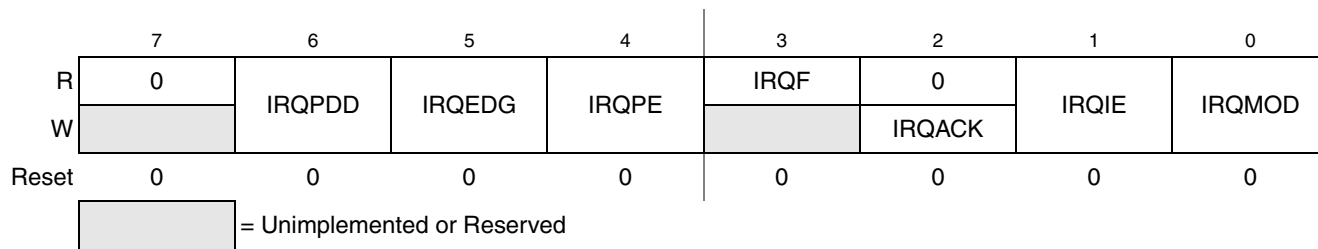

Figure 5-2. Interrupt Request Status and Control Register (IRQSC)



**Table 5-2. IRQSC Register Field Descriptions**

Field	Description
6 IRQPDD	<b>Interrupt Request (IRQ) Pull Device Disable</b> — This read/write control bit is used to disable the internal pullup device when the IRQ pin is enabled (IRQPE = 1) allowing for an external device to be used. 0 IRQ pull device enabled if IRQPE = 1. 1 IRQ pull device disabled if IRQPE = 1.
5 IRQEDG	<b>Interrupt Request (IRQ) Edge Select</b> — This read/write control bit is used to select the polarity of edges or levels on the IRQ pin that cause IRQF to be set. The IRQMOD control bit determines whether the IRQ pin is sensitive to both edges and levels or only edges. When the IRQ pin is enabled as the IRQ input and is configured to detect rising edges, the optional pullup resistor is re-configured as an optional pulldown resistor. 0 IRQ is falling edge or falling edge/low-level sensitive. 1 IRQ is rising edge or rising edge/high-level sensitive.
4 IRQPE	<b>IRQ Pin Enable</b> — This read/write control bit enables the IRQ pin function. When this bit is set the IRQ pin can be used as an interrupt request. 0 IRQ pin function is disabled. 1 IRQ pin function is enabled.
3 IRQF	<b>IRQ Flag</b> — This read-only status bit indicates when an interrupt request event has occurred. 0 No IRQ request. 1 IRQ event detected.
2 IRQACK	<b>IRQ Acknowledge</b> — This write-only bit is used to acknowledge interrupt request events (write 1 to clear IRQF). Writing 0 has no meaning or effect. Reads always return 0. If edge-and-level detection is selected (IRQMOD = 1), IRQF cannot be cleared while the IRQ pin remains at its asserted level.
1 IRQIE	<b>IRQ Interrupt Enable</b> — This read/write control bit determines whether IRQ events generate an interrupt request. 0 Interrupt request when IRQF set is disabled (use polling). 1 Interrupt requested whenever IRQF = 1.
0 IRQMOD	<b>IRQ Detection Mode</b> — This read/write control bit selects either edge-only detection or edge-and-level detection. See <a href="#">Section 5.5.2.2, “Edge and Level Sensitivity,”</a> for more details. 0 IRQ event on falling/rising edges only. 1 IRQ event on falling/rising edges and low/high levels.



## 5.7.2 System Reset Status Register (SRS)

This register includes six read-only status flags to indicate the source of the most recent reset. When a debug host forces reset by writing 1 to BDFR in the SBDFR register, none of the status bits in SRS will be set. Writing any value to this register address clears the COP watchdog timer without affecting the contents of this register. The reset state of these bits depends on what caused the MCU to reset.

	7	6	5	4	3	2	1	0
R	POR	PIN	COP	ILOP	ILAD	0	LVD	—
W	Writing 0x55 and then writing 0xAA to SRS address clears COP watchdog timer.							
POR	1	0	0	0	0	0	1	0
LVR:	U	0	0	0	0	0	1	0
Any other reset:	0	(1)	(1)	(1)	0	0	0	0

U = Unaffected by reset

- <sup>1</sup> Any of these reset sources that are active at the time of reset will cause the corresponding bit(s) to be set; bits corresponding to sources that are not active at the time of reset will be cleared.

**Figure 5-3. System Reset Status (SRS)**

**Table 5-3. SRS Register Field Descriptions**

Field	Description
7 POR	<b>Power-On Reset</b> — Reset was caused by the power-on detection logic. Because the internal supply voltage was ramping up at the time, the low-voltage reset (LVR) status bit is also set to indicate that the reset occurred while the internal supply was below the LVR threshold. 0 Reset not caused by POR. 1 POR caused reset.
6 PIN	<b>External Reset Pin</b> — Reset was caused by an active-low level on the external reset pin. 0 Reset not caused by external reset pin. 1 Reset came from external reset pin.
5 COP	<b>Computer Operating Properly (COP) Watchdog</b> — Reset was caused by the COP watchdog timer timing out. This reset source may be blocked by COPE = 0. 0 Reset not caused by COP timeout. 1 Reset caused by COP timeout.
4 ILOP	<b>Illegal Opcode</b> — Reset was caused by an attempt to execute an unimplemented or illegal opcode. The STOP instruction is considered illegal if stop is disabled by STOPE = 0 in the SOPT register. The BGND instruction is considered illegal if active background mode is disabled by ENBDM = 0 in the BDCSC register. 0 Reset not caused by an illegal opcode. 1 Reset caused by an illegal opcode.

**Table 5-3. SRS Register Field Descriptions (continued)**

Field	Description
3 ILAD	<b>Illegal Address</b> — Reset was caused by an attempt to access a illegal address. 0 Reset not caused by an illegal address. 1 Reset caused by an illegal address.
1 LVD	<b>Low Voltage Detect</b> — If the LVDRE bit is set in run mode or both LVDRE and LVDSE bits are set in stop mode, and the supply drops below the LVD trip voltage, an LVD reset will occur. This bit is also set by POR. 0 Reset not caused by LVD trip or POR. 1 Reset caused by LVD trip or POR.

### 5.7.3 System Background Debug Force Reset Register (SBDFR)

This register contains a single write-only control bit. A serial background command such as WRITE\_BYTE must be used to write to SBDFR. Attempts to write this register from a user program are ignored. Reads always return 0x00.

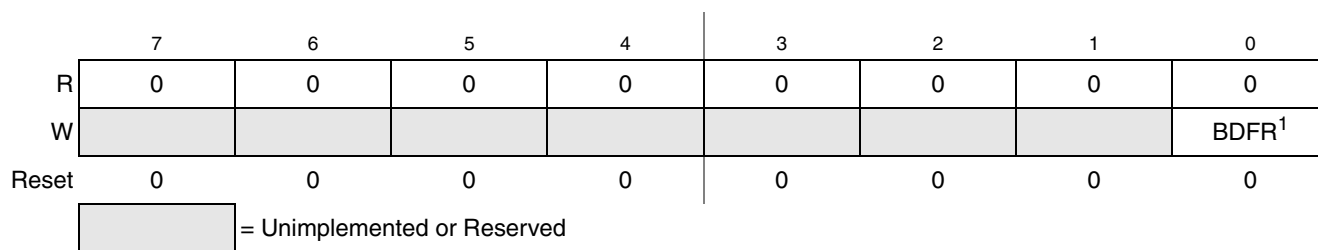

<sup>1</sup> BDFR is writable only through serial background debug commands, not from user programs.

**Figure 5-4. System Background Debug Force Reset Register (SBDFR)**

**Table 5-4. SBDFR Register Field Descriptions**

Field	Description
0 BDFR	<b>Background Debug Force Reset</b> — A serial background command such as WRITE_BYTE may be used to allow an external debug host to force a target system reset. Writing logic 1 to this bit forces an MCU reset. This bit cannot be written from a user program.

### 5.7.4 System Options Register 1 (SOPT1)

This register may be read at any time. Bits 3 and 2 are unimplemented and always read 0. This is a write-once register except for TCLKPEN so only the first write after reset is honored. Any subsequent attempt to write to SOPT1 (intentionally or unintentionally) is ignored to avoid accidental changes to these sensitive settings. SOPT1 must be written during the user’s reset initialization program to set the desired controls even if the desired settings are the same as the reset settings.

	7	6	5	4	3	2	1	0	
R	COPT			STOPE	TCLKPEN	0	0	BKGDPE	RSTPE
W									
Reset	1	1	0	0	0	0	1	U	
POR	1	1	0	0	0	0	1	0	

= Unimplemented or Reserved

<sup>1</sup> User must not write 1 to bit 3 or bit 2.

**Figure 5-5. System Options Register (SOPT1)**

**Table 5-5. SOPT1 Register Field Descriptions**

Field	Description
7:6 COPT[1:0]	<b>COP Watchdog Timeout</b> — These write-once bits select the timeout period of the COP. COPT and COPCLKS in SOPT2 define the COP timeout period. See <a href="#">Table 5-6</a> .
5 STOPE	<b>Stop Mode Enable</b> — This write-once bit defaults to 0 after reset, which disables stop mode. If stop mode is disabled and a user program attempts to execute a STOP instruction, an illegal opcode reset occurs. 0 Stop mode disabled. 1 Stop mode enabled.
4 TCLKPEN	<b>TCLK Pin Enable</b> — This bit defaults to 0 after reset, which disables TCLK as TPM and MTIM16 as alternate clock and ADC hardware trigger. 0 PTA5/IRQ/TCLK/ $\overline{\text{RESET}}$ pin functions as PTA5, IRQ, or $\overline{\text{RESET}}$ 1 PTA5/IRQ/TCLK/ $\overline{\text{RESET}}$ pin functions as TCLK
1 BKGDPE	<b>Background Debug Mode Pin Enable</b> — This write-once bit when set enables the PTA4/BKGD/MS pin to function as BKGD/MS. When clear, the pin functions as output only PTA4. This pin defaults to the BKGD/MS function following any MCU reset. 0 PTA4/BKGD/MS pin functions as PTA4. 1 PTA4/BKGD/MS pin functions as BKGD/MS.
0 RSTPE	<b><math>\overline{\text{RESET}}</math> Pin Enable</b> — This write-once bit can be written whenever after any reset. When RSTPE is set, the PTA5/IRQ/TCLK/ $\overline{\text{RESET}}$ pin functions as $\overline{\text{RESET}}$ . When clear, the pin functions as one of its alternative functions. This pin defaults to PTA5 following an MCU POR. Other resets will not affect this bit. When RSTPE is set, an internal pullup device on $\overline{\text{RESET}}$ is enabled. 0 PTA5/IRQ/TCLK/ $\overline{\text{RESET}}$ pin functions as PTA5, IRQ, or TCLK. 1 PTA5/IRQ/TCLK/ $\overline{\text{RESET}}$ pin functions as $\overline{\text{RESET}}$ .

Table 5-6. COP Configuration Options

Control Bits		Clock Source	COP Window <sup>1</sup> Opens (COPW = 1)	COP Overflow Count
COPCLKS	COPT[1:0]			
N/A	0:0	N/A	N/A	COP is disabled
0	0:1	1 kHz	N/A	2 <sup>5</sup> cycles (32 ms <sup>2</sup> )
0	1:0	1 kHz	N/A	2 <sup>8</sup> cycles (256 ms <sup>1</sup> )
0	1:1	1 kHz	N/A	2 <sup>10</sup> cycles (1.024 s <sup>1</sup> )
1	0:1	Bus	6144 cycles	2 <sup>13</sup> cycles
1	1:0	Bus	49,152 cycles	2 <sup>16</sup> cycles
1	1:1	Bus	196,608 cycles	2 <sup>18</sup> cycles

<sup>1</sup> Windowed COP operation requires the user to clear the COP timer in the last 25% of the selected timeout period. This column displays the minimum number of clock counts required before the COP timer can be reset when in windowed COP mode (COPW = 1).

<sup>2</sup> Values shown in milliseconds based on  $t_{LPO} = 1$  ms. See  $t_{LPO}$  in the *MC9S08FL16 Series Data Sheet* for the tolerance of this value.

## 5.7.5 System Options Register 2 (SOPT2)

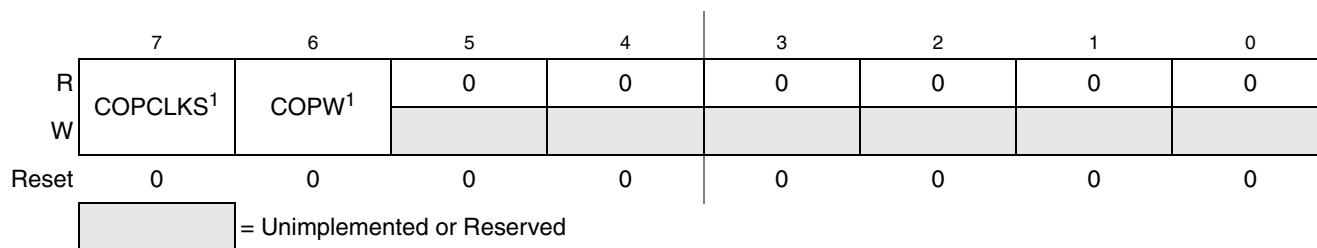

<sup>1</sup> This bit can be written only once after reset. Additional writes are ignored.

Figure 5-6. System Options Register 2 (SOPT2)

Table 5-7. SOPT2 Register Field Descriptions

Field	Description
7 COPCLKS	<b>COP Watchdog Clock Select</b> — This write-once bit selects the clock source of the COP watchdog. 0 Internal 1 kHz clock is source to COP. 1 Bus clock is source to COP.
6 COPW	<b>COP Window</b> — This write-once bit selects the COP operation mode. When set, the 0x55-0xAA write sequence to the SRS register must occur in the last 25% of the selected period. Any write to the SRS register during the first 75% of the selected period will reset the MCU. 0 Normal COP operation. 1 Window COP operation.

## 5.7.6 System Device Identification Register (SDIDH, SDIDL)

This read-only register is included so host development systems can identify the HCS08 derivative and revision number. This allows the development software to recognize where specific memory blocks, registers, and control bits are located in a target MCU.

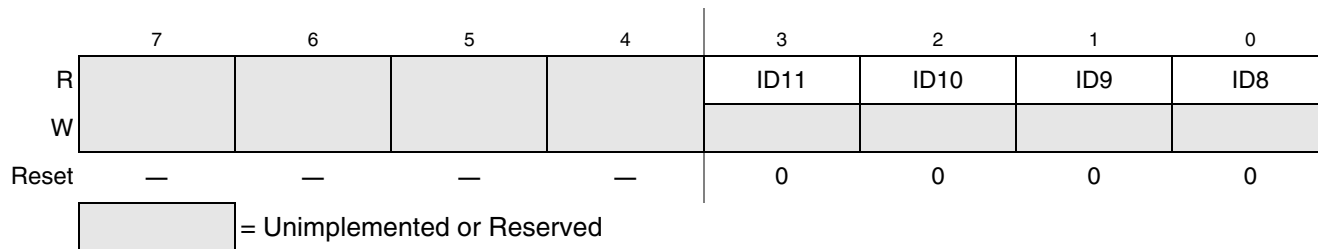

**Figure 5-7. System Device Identification Register — High (SDIDH)**

**Table 5-8. SDIDH Register Field Descriptions**

Field	Description
7:4 Reserved	<b>Bits 7:4 are reserved. Reading these bits will result in an indeterminate value; writes have no effect.</b>
3:0 ID[11:8]	<b>Part Identification Number</b> — Each derivative in the HCS08 Family has a unique identification number. The MC9S08FL16 series are hard coded to the value 0x29. See also ID bits in <a href="#">Table 5-9</a> .

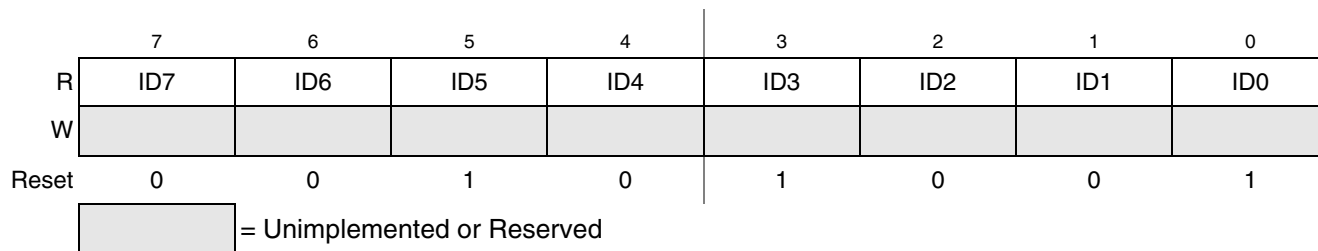

**Figure 5-8. System Device Identification Register — Low (SDIDL)**

**Table 5-9. SDIDL Register Field Descriptions**

Field	Description
7:0 ID[7:0]	<b>Part Identification Number</b> — Each derivative in the HCS08 family has a unique identification number. The MC9S08FL16 series are hard coded to the value 0x29. See also ID bits in <a href="#">Table 5-8</a> .

## 5.7.7 System Power Management Status and Control 1 Register (SPMSC1)

This high-page register contains status and control bits to support the low-voltage detect function, and to enable the bandgap voltage reference for use by the ADC module. This register should be written during the user's reset initialization program to set the desired controls even if the desired settings are the same as the reset settings.

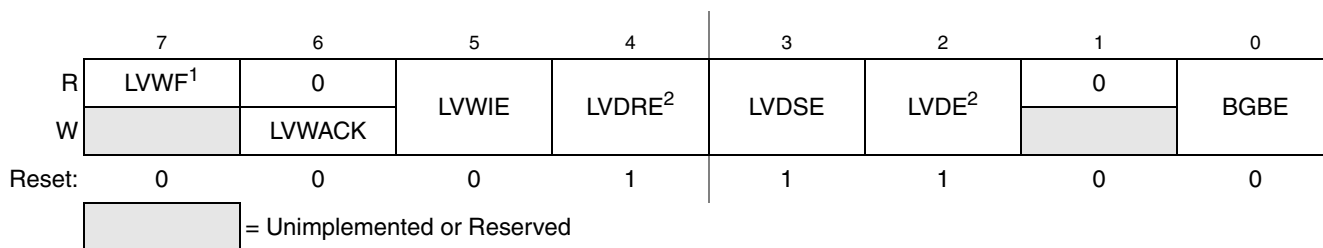

<sup>1</sup> LVWF will be set in the case when  $V_{Supply}$  transitions below the trip point or after reset and  $V_{Supply}$  is already below  $V_{LVW}$ .

<sup>2</sup> This bit can be written only once after reset. Additional writes are ignored.

**Figure 5-9. System Power Management Status and Control 1 Register (SPMSC1)**

**Table 5-10. SPMSC1 Register Field Descriptions**

Field	Description
7 LVWF	<b>Low-Voltage Warning Flag</b> — The LVWF bit indicates the low-voltage warning status. 0 Low-voltage warning is not present. 1 Low-voltage warning is present or was present.
6 LVWACK	<b>Low-Voltage Warning Acknowledge</b> — If LVWF = 1, a low-voltage condition has occurred. To acknowledge this low-voltage warning, write 1 to LVWACK, which automatically clears LVWF to 0 if the low-voltage warning is no longer present.
5 LVWIE	<b>Low-Voltage Warning Interrupt Enable</b> — This bit enables hardware interrupt requests for LVWF. 0 Hardware interrupt disabled (use polling). 1 Request a hardware interrupt when LVWF = 1.
4 LVDRE	<b>Low-Voltage Detect Reset Enable</b> — This write-once bit enables LVD events to generate a hardware reset (provided LVDE = 1). 0 LVD events do not generate hardware resets. 1 Force an MCU reset when an enabled low-voltage detect event occurs.
3 LVDSE	<b>Low-Voltage Detect Stop Enable</b> — Provided LVDE = 1, this read/write bit determines whether the low-voltage detect function operates when the MCU is in stop mode. 0 Low-voltage detect disabled during stop mode. 1 Low-voltage detect enabled during stop mode.
2 LVDE	<b>Low-Voltage Detect Enable</b> — This write-once bit enables low-voltage detect logic and qualifies the operation of other bits in this register. 0 LVD logic disabled. 1 LVD logic enabled.
0 BGBE	<b>Bandgap Buffer Enable</b> — This bit enables an internal buffer for the bandgap voltage reference for use by the ADC module on one of its internal channels. 0 Bandgap buffer disabled. 1 Bandgap buffer enabled.

## 5.7.8 System Power Management Status and Control 2 Register (SPMSC2)

This register is used to report the status of the low-voltage warning function, and to configure the stop mode behavior of the MCU. This register must be written during the user's reset initialization program to set the desired controls even if the desired settings are the same as the reset settings.

	7	6	5	4	3	2	1	0
R	0	0	LVDV	LVWV	PPDF	0	0	PPDC <sup>1</sup>
W							PPDACK	
Power-on Reset:	0	0	0	0	0	0	0	0
LVD Reset:	0	0	u	u	0	0	0	0
Any other Reset:	0	0	u	u	0	0	0	0

= Unimplemented or Reserved
 u = Unaffected by reset

<sup>1</sup> This bit can be written only once after reset. Additional writes are ignored.

**Figure 5-10. System Power Management Status and Control 2 Register (SPMSC2)**

**Table 5-11. SPMSC2 Register Field Descriptions**

Field	Description
5 LVDV	<b>Low-Voltage Detect Voltage Select</b> — This write-once bit selects the low-voltage detect (LVD) trip point setting. It also selects the warning voltage range. See <a href="#">Table 5-12</a> .
4 LVWV	<b>Low-Voltage Warning Voltage Select</b> — This bit selects the low-voltage warning (LVW) trip point voltage. See <a href="#">Table 5-12</a> .
3 PPDF	<b>Partial Power Down Flag</b> — This read-only status bit indicates that the MCU has recovered from stop2 mode. 0 MCU has not recovered from stop2 mode. 1 MCU recovered from stop2 mode.
2 PPDACK	<b>Partial Power Down Acknowledge</b> — Writing a 1 to PPDACK clears the PPDF bit.
0 PPDC	<b>Partial Power Down Control</b> — This write-once bit controls whether stop2 or stop3 mode is selected. 0 Stop3 mode enabled. 1 Stop2, partial power down, mode enabled.

**Table 5-12. LVD and LVW Trip Point Typical Values<sup>1</sup>**

LVDV:LVWV	LVW Trip Point	LVD Trip Point
0:0	Reserved.	
0:1		
1:0	$V_{LVW2} = 4.3 \text{ V}$	$V_{LVD1} = 4.0 \text{ V}$
1:1	$V_{LVW3} = 4.6 \text{ V}$	

<sup>1</sup> See *MC9S08FL16 Series Data Sheet* for minimum and maximum values.





## Chapter 6 Parallel Input/Output

### 6.1 Introduction

This chapter explains software controls related to parallel input/output (I/O). The MC9S08FL16 series have four I/O ports which include a total of 30 general-purpose I/O pins. See [Chapter 2, “Pins and Connections,”](#) for more information about the logic and hardware aspects of these pins.

Not all pins are available on all devices. See [Table 2-1](#) to determine which functions are available for a specific device.

Many of the I/O pins are shared with on-chip peripheral functions, as shown in [Table 2-1](#). The peripheral modules have priority over the I/Os, so when a peripheral is enabled, the I/O functions are disabled.

After reset, the shared peripheral functions are disabled so that the pins are controlled by the parallel I/O. All of the parallel I/O are configured as inputs ( $PTxDDn = 0$ ). The pin control functions for each pin are configured as follows: slew rate control enabled ( $PTxSEn = 1$ ), low drive strength selected ( $PTxDSn = 0$ ), and internal pullups disabled ( $PTxPEn = 0$ ).

#### NOTE

Not all general-purpose I/O pins are available on all packages. To avoid extra current drain from floating input pins, the user's reset initialization routine in the application program should either enable on-chip pullup devices or change the direction of unconnected pins to outputs so the pins do not float.

### 6.2 Port Data and Data Direction

Reading and writing of parallel I/O is done through the port data registers. The direction, input or output, is controlled through the port data direction registers. The parallel I/O port function for an individual pin is illustrated in the block diagram below.

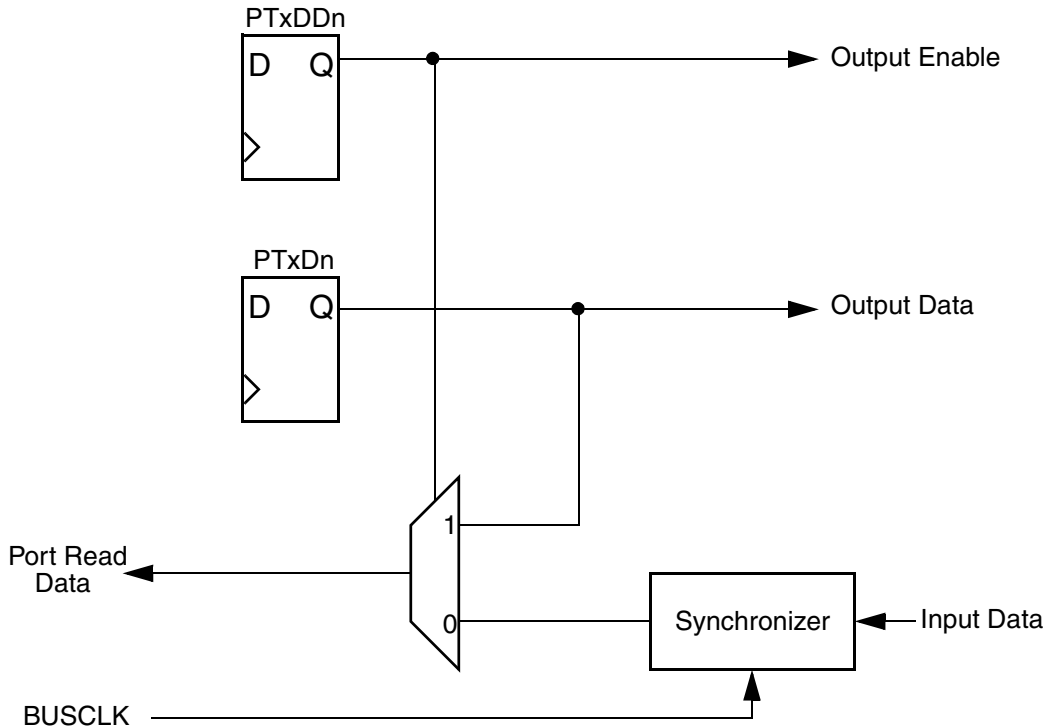

**Figure 6-1. Parallel I/O Block Diagram**

The data direction control bits determine whether the pin output driver is enabled. They also control what is read during port data register reads. Each port pin has a data direction register bit. When  $PTxDDn = 0$ , the corresponding pin is an input and reads of  $PTxD$  return the pin value. When  $PTxDDn = 1$ , the corresponding pin is an output and reads of  $PTxD$  return the last value written to the port data register. When a peripheral module or system function is in control of a port pin, the data direction register bit still controls what is returned for reads of the port data register, even though the peripheral system has overriding control of the actual pin direction.

When a shared analog function is enabled for a pin, all digital pin functions are disabled. A read of the port data register returns a value of 0 for any bits which have shared analog functions enabled. In general, whenever a pin is shared with both an alternate digital function and an analog function, the analog function has priority such that if both the digital and analog functions are enabled, the analog function controls the pin.

Write to the port data register before changing the direction of a port pin to become an output. This ensures that the pin will not be driven momentarily with an old data value that happened to be in the port data register.

### 6.3 Pin Control

The pin control registers are located in the high-page register block of the memory. These registers are used to control pullups, slew rate, and drive strength for the I/O pins. The pin control registers operate independently of the parallel I/O registers.

### 6.3.1 Internal Pullup Enable

An internal pullup device can be enabled for each port pin by setting the corresponding bit in one of the pullup enable registers (PTxPE<sub>n</sub>). The pullup device is disabled if the pin is configured as an output by the parallel I/O control logic or any shared peripheral function regardless of the state of the corresponding pullup enable register bit. The pullup device is also disabled if the pin is controlled by an analog function.

### 6.3.2 Output Slew Rate Control Enable

Slew rate control can be enabled for each port pin by setting the corresponding bit in one of the slew rate control registers (PTxSE<sub>n</sub>). When enabled, slew control limits the rate at which an output can transition. This reduces EMC emissions. Slew rate control has no effect on pins which are configured as inputs.

### 6.3.3 Output Drive Strength Select

An output pin can be selected to have high output drive strength by setting the corresponding bit in one of the drive strength select registers (PTxDS<sub>n</sub>). When high drive is selected, a pin can source and sink greater current. Even though every I/O pin can be selected as high drive, the user must ensure that the total current source and sink limits for the chip are not exceeded. Drive strength selection affects the DC behavior of I/O pins. However, the AC behavior is also affected. High drive allows a pin to drive a greater load with the same switching speed as a low-drive enabled pin into a smaller load. Because of this, the EMC emissions may be affected by enabling pins as high drive.

## 6.4 Pin Behavior in Stop Modes

Depending on the stop mode, I/O functions differently as the result of executing a STOP instruction. An explanation of I/O behavior for the various stop modes follows:

- Stop2 mode is a partial power-down mode, whereby I/O latches are maintained in their state from before the STOP instruction was executed. CPU register status and the state of I/O registers should be saved in RAM before the STOP instruction is executed to place the MCU in stop2 mode. Upon recovery from stop2 mode, before accessing any I/O, the user should examine the state of the PPDF bit in the SPMSC2 register. If the PPDF bit is 0, I/O must be initialized as if a power on reset had occurred. If the PPDF bit is 1, before the STOP instruction was executed, peripherals may require being initialized and restored I/O data previously stored in RAM to their pre-stop condition. The user must then write a 1 to the PPDACK bit in the SPMSC2 register. Access to I/O is permitted again in the user’s application program.
- In stop3 mode, all I/O is maintained because internal logic circuitry stays powered up. Upon recovery, normal I/O function is available to the user.

## 6.5 Parallel I/O and Pin Control Registers

This section provides information about the registers associated with the parallel I/O ports and pin control functions. These parallel I/O registers are located on page zero of the memory map and the pin control registers are located in the high-page register section of memory.

Refer to the tables in [Chapter 4, “Memory,”](#) for the absolute address assignments for all parallel I/O and pin control registers. This section refers to registers and control bits only by their names. A Freescale-provided equate or header file is normally used to translate these names into the appropriate absolute addresses.

### 6.5.1 Port A I/O Registers (PTAD and PTADD)

Port A parallel I/O function is controlled by the registers listed below.

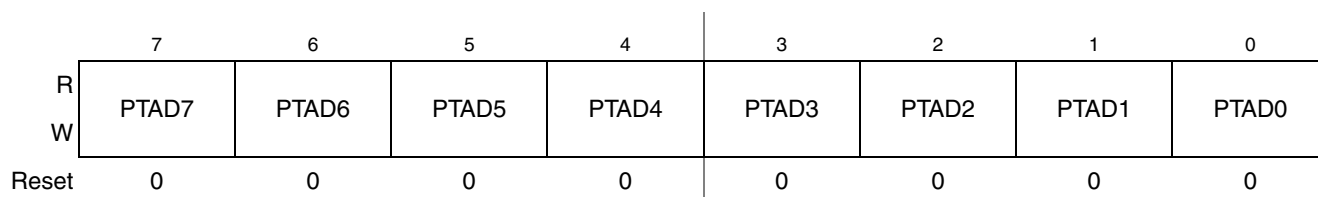

**Figure 6-2. Port A Data Register (PTAD)**

**Table 6-1. PTAD Register Field Descriptions**

Field	Description
7:0 PTAD[7:0]	<p><b>Port A Data Register Bits</b> — For port A pins that are inputs, reads return the logic level on the pin. For port A pins that are configured as outputs, reads return the last value written to this register. Writes are latched into all bits of this register. For port A pins that are configured as outputs, the logic level is driven out the corresponding MCU pin. Reset forces PTAD to all 0s, but these 0s are not driven out the corresponding pins because reset also configures all port pins as high-impedance inputs with pullups disabled.</p>

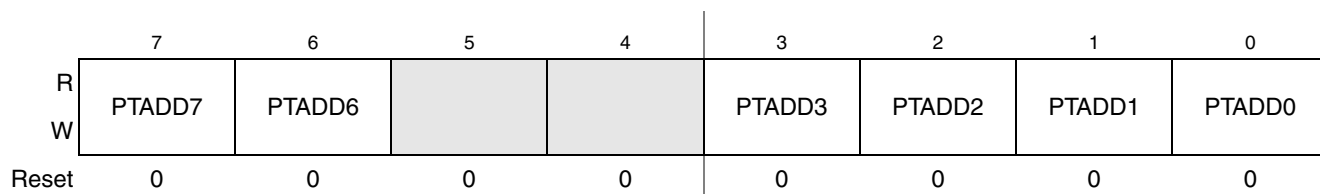

Figure 6-3. Data Direction for Port A Register (PTADD)

Table 6-2. PTADD Register Field Descriptions

Field	Description
7:6,3:0 PTADD[7:6, 3:0]	<b>Data Direction for Port A Bits</b> — These read/write bits control the direction of port A pins and what is read for PTAD reads. 0 Input (output driver disabled) and reads return the pin value. 1 Output driver enabled for port A bit n and PTAD reads return the contents of PTADn.

## 6.5.2 Port A Pin Control Registers (PTAPE, PTASE, PTADS)

In addition to the I/O control, port A pins are controlled by the registers listed below.

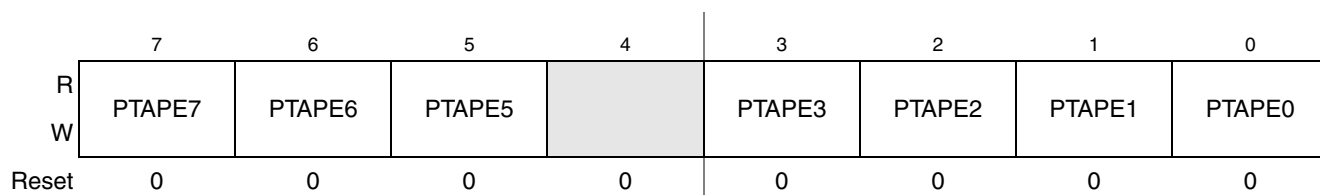

Figure 6-4. Internal Pullup Enable for Port A (PTAPE)

Table 6-3. PTAPE Register Field Descriptions

Field	Description
[7:5,3:0] PTAPE[7:5,3 :0]	<b>Internal Pullup Enable for Port A Bits</b> — Each of these control bits determines if the internal pullup device is enabled for the associated PTA pin. For port A pins that are configured as outputs, these bits have no effect and the internal pullup devices are disabled. 0 Internal pullup device disabled for port A bit n. 1 Internal pullup device enabled for port A bit n.

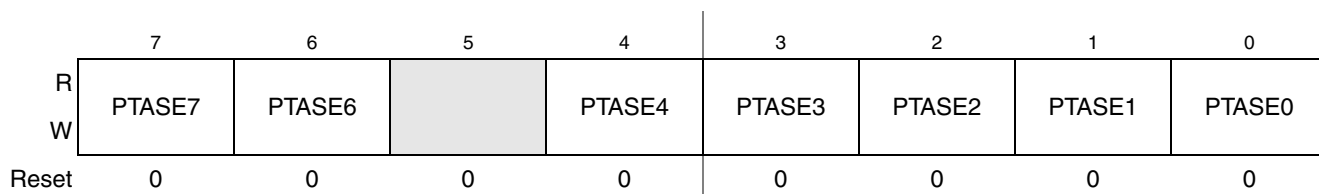

Figure 6-5. Output Slew Rate Control Enable for Port A (PTASE)

Table 6-4. PTASE Register Field Descriptions

Field	Description
7:6,4:0 PTASE[7:6,4:0]	<b>Output Slew Rate Control Enable for Port A Bits</b> — Each of these control bits determine whether output slew rate control is enabled for the associated PTA pin. For port A pins that are configured as inputs, these bits have no effect. 0 Output slew rate control disabled for port A bit n. 1 Output slew rate control enabled for port A bit n.

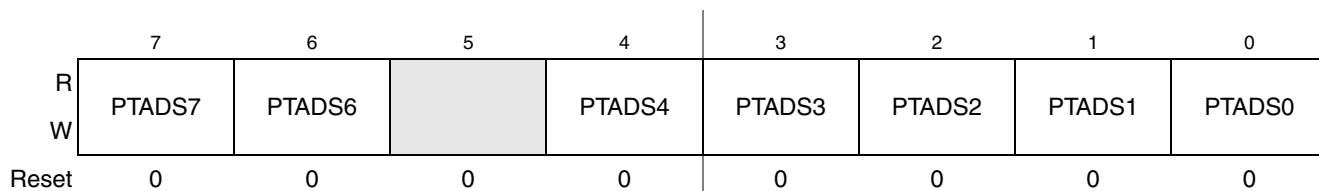

Figure 6-6. Output Drive Strength Selection for Port A (PTADS)

Table 6-5. PTADS Register Field Descriptions

Field	Description
7:6,4:0 PTADS[7:6,4:0]	<b>Output Drive Strength Selection for Port A Bits</b> — Each of these control bits selects between low and high output drive for the associated PTA pin. 0 Low output drive enabled for port A bit n. 1 High output drive enabled for port A bit n.

### 6.5.3 Port B I/O Registers (PTBD and PTBDD)

Port B parallel I/O function is controlled by the registers listed below.

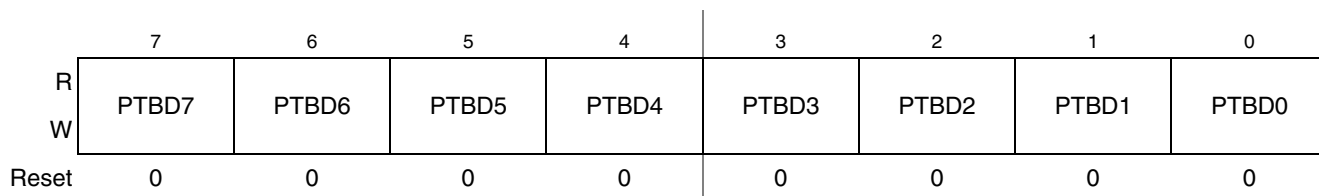
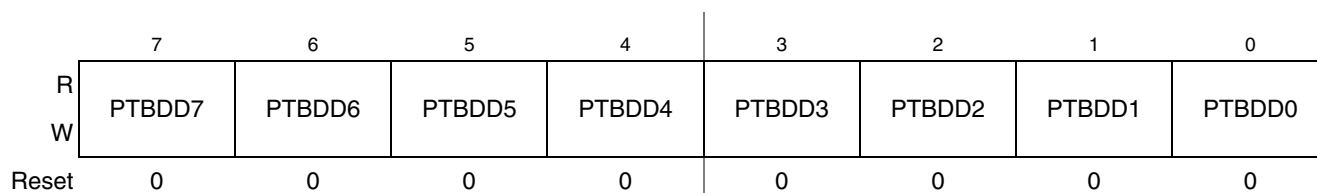

Figure 6-7. Port B Data Register (PTBD)

**Table 6-6. PTBD Register Field Descriptions**

Field	Description
7:0 PTBD[7:0]	<p><b>Port B Data Register Bits</b> — For port B pins that are inputs, reads return the logic level on the pin. For port B pins that are configured as outputs, reads return the last value written to this register. Writes are latched into all bits of this register. For port B pins that are configured as outputs, the logic level is driven out the corresponding MCU pin.</p> <p>Reset forces PTBD to all 0s, but these 0s are not driven out the corresponding pins because reset also configures all port pins as high-impedance inputs with pullups disabled.</p>

**Figure 6-8. Data Direction for Port B Register (PTBDD)**
**Table 6-7. PTBDD Register Field Descriptions**

Field	Description
7:0 PTBDD[7:0]	<p><b>Data Direction for Port B Bits</b> — These read/write bits control the direction of port B pins and what is read for PTBD reads.</p> <p>0 Input (output driver disabled) and reads return the pin value.</p> <p>1 Output driver enabled for port B bit n and PTBD reads return the contents of PTBDn.</p>

### 6.5.4 Port B Pin Control Registers (PTBPE, PTBSE, PTBDS)

In addition to the I/O control, port B pins are controlled by the registers listed below.

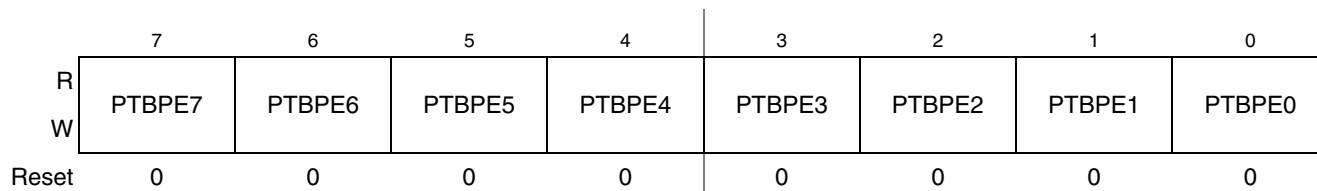
**Figure 6-9. Internal Pullup Enable for Port B (PTBPE)**
**Table 6-8. PTBPE Register Field Descriptions**

Field	Description
[7:0] PTBPE[7:0]	<p><b>Internal Pullup Enable for Port B Bits</b> — Each of these control bits determines if the internal pullup device is enabled for the associated PTB pin. For port B pins that are configured as outputs, these bits have no effect and the internal pullup devices are disabled.</p> <p>0 Internal pullup device disabled for port B bit n.</p> <p>1 Internal pullup device enabled for port B bit n.</p>

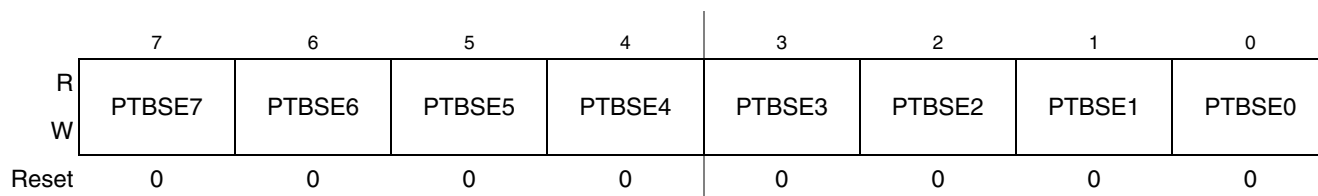

Figure 6-10. Output Slew Rate Control Enable for Port B (PTBSE)

Table 6-9. PTBSE Register Field Descriptions

Field	Description
7:0 PTBSE[7:0]	<b>Output Slew Rate Control Enable for Port B Bits</b> — Each of these control bits determine whether output slew rate control is enabled for the associated PTB pin. For port B pins that are configured as inputs, these bits have no effect. 0 Output slew rate control disabled for port B bit n. 1 Output slew rate control enabled for port B bit n.

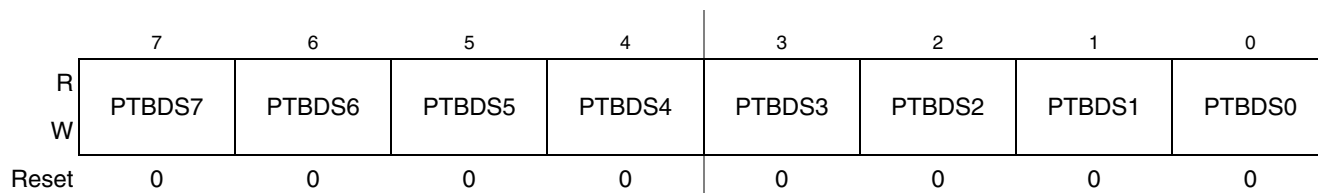

Figure 6-11. Output Drive Strength Selection for Port B (PTBDS)

Table 6-10. PTBDS Register Field Descriptions

Field	Description
7:0 PTBDS[7:0]	<b>Output Drive Strength Selection for Port B Bits</b> — Each of these control bits selects between low and high output drive for the associated PTB pin. 0 Low output drive enabled for port B bit n. 1 High output drive enabled for port B bit n.

### 6.5.5 Port C I/O Registers (PTCD and PTCDD)

Port C parallel I/O function is controlled by the registers listed below.

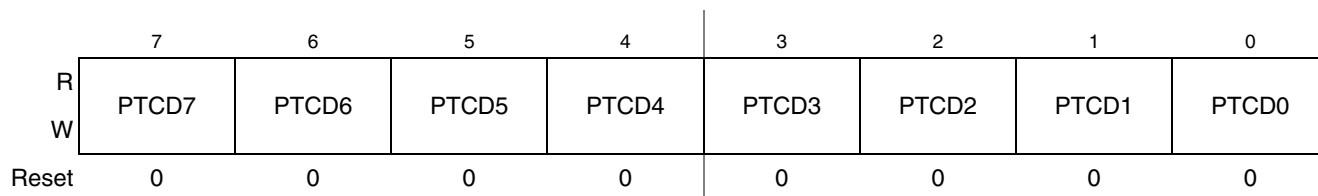
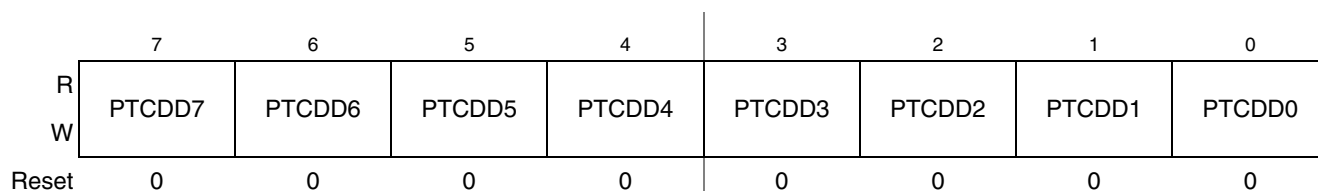

Figure 6-12. Port C Data Register (PTCD)



**Table 6-11. PTCDD Register Field Descriptions**

Field	Description
7:0 PTCD[7:0]	<p><b>Port C Data Register Bits</b> — For port C pins that are inputs, reads return the logic level on the pin. For port C pins that are configured as outputs, reads return the last value written to this register. Writes are latched into all bits of this register. For port C pins that are configured as outputs, the logic level is driven out the corresponding MCU pin.</p> <p>Reset forces PTCDD to all 0s, but these 0s are not driven out the corresponding pins because reset also configures all port pins as high-impedance inputs with pullups disabled.</p>

**Figure 6-13. Data Direction for Port C Register (PTCDD)**
**Table 6-12. PTCDD Register Field Descriptions**

Field	Description
7:0 PTCDD[7:0]	<p><b>Data Direction for Port C Bits</b> — These read/write bits control the direction of port C pins and what is read for PTCDD reads.</p> <p>0 Input (output driver disabled) and reads return the pin value.</p> <p>1 Output driver enabled for port C bit n and PTCDD reads return the contents of PTCDDn.</p>

### 6.5.6 Port C Pin Control Registers (PTCPE, PTCSE, PTCDS)

In addition to the I/O control, port C pins are controlled by the registers listed below.

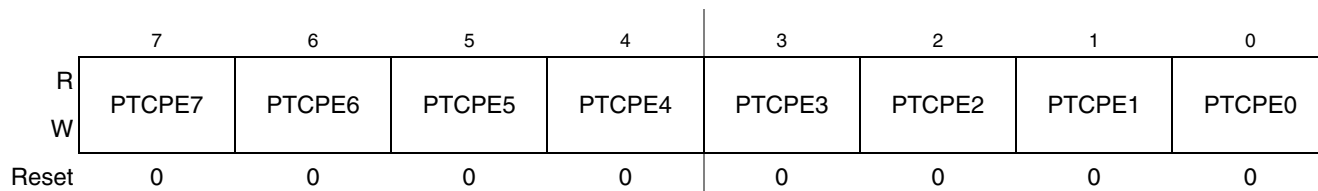
**Figure 6-14. Internal Pullup Enable for Port C (PTCPE)**
**Table 6-13. PTCPE Register Field Descriptions**

Field	Description
[7:0] PTCPE[7:0]	<p><b>Internal Pullup Enable for Port C Bits</b> — Each of these control bits determines if the internal pullup device is enabled for the associated PTC pin. For port C pins that are configured as outputs, these bits have no effect and the internal pullup devices are disabled.</p> <p>0 Internal pullup device disabled for port C bit n.</p> <p>1 Internal pullup device enabled for port C bit n.</p>

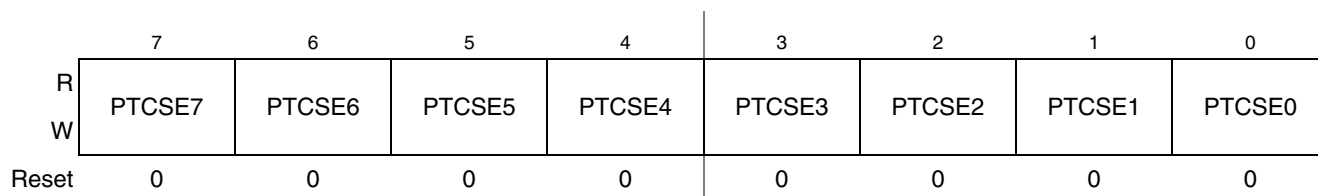

Figure 6-15. Output Slew Rate Control Enable for Port C (PTCSE)

Table 6-14. PTCSE Register Field Descriptions

Field	Description
7:0 PTCSE[7:0]	<p><b>Output Slew Rate Control Enable for Port C Bits</b> — Each of these control bits determine whether output slew rate control is enabled for the associated PTC pin. For port C pins that are configured as inputs, these bits have no effect.</p> <p>0 Output slew rate control disabled for port C bit n. 1 Output slew rate control enabled for port C bit n.</p>

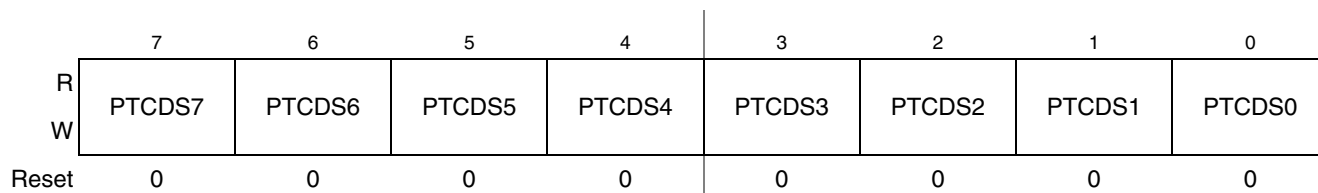

Figure 6-16. Output Drive Strength Selection for Port C (PTCDS)

Table 6-15. PTCDS Register Field Descriptions

Field	Description
7:0 PTCDS[7:0]	<p><b>Output Drive Strength Selection for Port C Bits</b> — Each of these control bits selects between low and high output drive for the associated PTC pin.</p> <p>0 Low output drive enabled for port C bit n. 1 High output drive enabled for port C bit n.</p>

### 6.5.7 Port D I/O Registers (PTDD and PTDDD)

Port D parallel I/O function is controlled by the registers listed below.

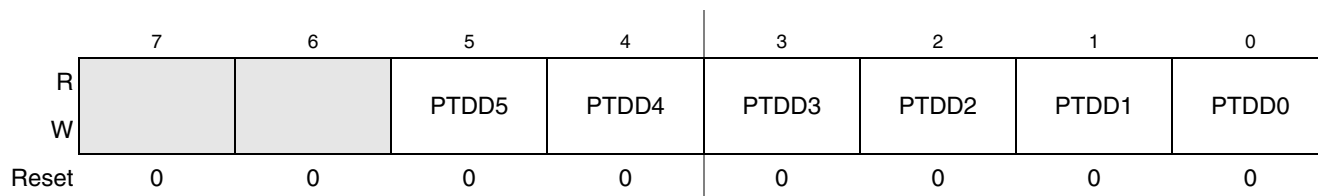
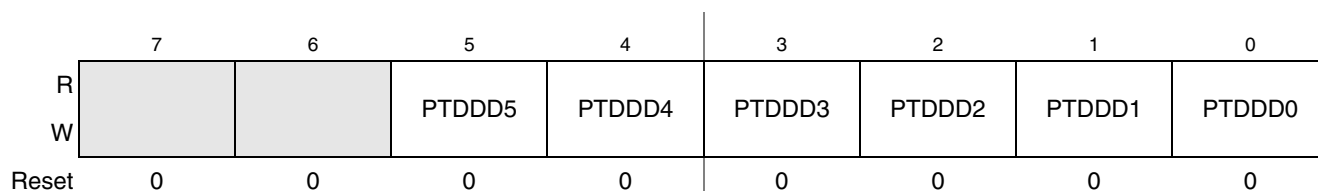

Figure 6-17. Port D Data Register (PTDD)

**Table 6-16. PTDD Register Field Descriptions**

Field	Description
5:0 PTDD[5:0]	<b>Port D Data Register Bits</b> — For port D pins that are inputs, reads return the logic level on the pin. For port D pins that are configured as outputs, reads return the last value written to this register. Writes are latched into all bits of this register. For port D pins that are configured as outputs, the logic level is driven out the corresponding MCU pin. Reset forces PTDD to all 0s, but these 0s are not driven out the corresponding pins because reset also configures all port pins as high-impedance inputs with pullups disabled.

**Figure 6-18. Data Direction for Port D Register (PTDDD)**
**Table 6-17. PTDDD Register Field Descriptions**

Field	Description
5:0 PTDDD[5:0]	<b>Data Direction for Port D Bits</b> — These read/write bits control the direction of port D pins and what is read for PTDD reads. 0 Input (output driver disabled) and reads return the pin value. 1 Output driver enabled for port D bit n and PTDD reads return the contents of PTDDn.

### 6.5.8 Port D Pin Control Registers (PTDPE, PTDSE, PTDDS)

In addition to the I/O control, port D pins are controlled by the registers listed below.

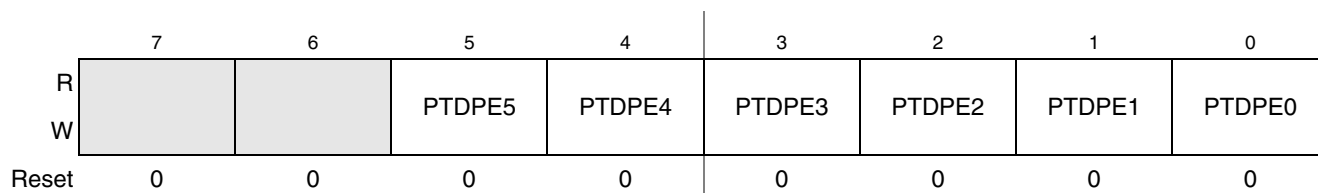
**Figure 6-19. Internal Pullup Enable for Port D (PTDPE)**
**Table 6-18. PTDPE Register Field Descriptions**

Field	Description
[5:0] PTDPE[5:0]	<b>Internal Pullup Enable for Port D Bits</b> — Each of these control bits determines if the internal pullup device is enabled for the associated PTD pin. For port D pins that are configured as outputs, these bits have no effect and the internal pullup devices are disabled. 0 Internal pullup device disabled for port D bit n. 1 Internal pullup device enabled for port D bit n.

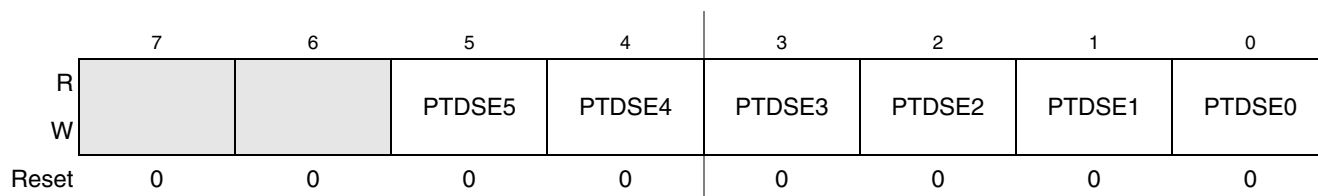

Figure 6-20. Output Slew Rate Control Enable for Port D (PTDSE)

Table 6-19. PTDSE Register Field Descriptions

Field	Description
5:0 PTDSE[5:0]	<b>Output Slew Rate Control Enable for Port D Bits</b> — Each of these control bits determine whether output slew rate control is enabled for the associated PTD pin. For port D pins that are configured as inputs, these bits have no effect. 0 Output slew rate control disabled for port D bit n. 1 Output slew rate control enabled for port D bit n.

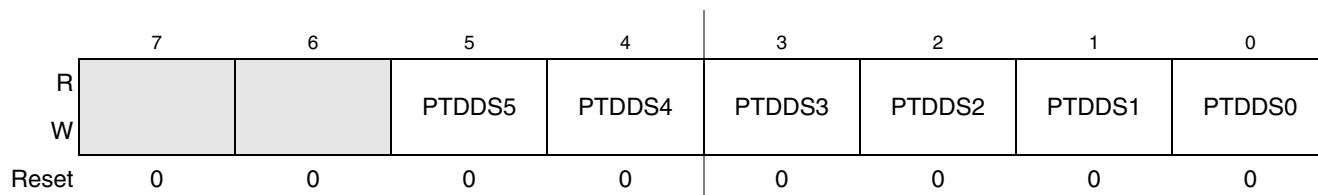

Figure 6-21. Output Drive Strength Selection for Port D (PTDDS)

Table 6-20. PTDDS Register Field Descriptions

Field	Description
5:0 PTDDS[5:0]	<b>Output Drive Strength Selection for Port D Bits</b> — Each of these control bits selects between low and high output drive for the associated PTD pin. 0 Low output drive enabled for port D bit n. 1 High output drive enabled for port D bit n.

## Chapter 7

# Central Processor Unit (S08CPUV3)

### 7.1 Introduction

This section provides summary information about the registers, addressing modes, and instruction set of the CPU of the HCS08 Family. For a more detailed discussion, refer to the *HCS08 Family Reference Manual, volume 1*, Freescale Semiconductor document order number HCS08RMV1/D.

The HCS08 CPU is fully source- and object-code-compatible with the M68HC08 CPU. Several instructions and enhanced addressing modes were added to improve C compiler efficiency and to support a new background debug system which replaces the monitor mode of earlier M68HC08 microcontrollers (MCU).

#### 7.1.1 Features

Features of the HCS08 CPU include:

- Object code fully upward-compatible with M68HC05 and M68HC08 Families
- All registers and memory are mapped to a single 64-Kbyte address space
- 16-bit stack pointer (any size stack anywhere in 64-Kbyte address space)
- 16-bit index register (H:X) with powerful indexed addressing modes
- 8-bit accumulator (A)
- Many instructions treat X as a second general-purpose 8-bit register
- Seven addressing modes:
  - Inherent — Operands in internal registers
  - Relative — 8-bit signed offset to branch destination
  - Immediate — Operand in next object code byte(s)
  - Direct — Operand in memory at 0x0000–0x00FF
  - Extended — Operand anywhere in 64-Kbyte address space
  - Indexed relative to H:X — Five submodes including auto increment
  - Indexed relative to SP — Improves C efficiency dramatically
- Memory-to-memory data move instructions with four address mode combinations
- Overflow, half-carry, negative, zero, and carry condition codes support conditional branching on the results of signed, unsigned, and binary-coded decimal (BCD) operations
- Efficient bit manipulation instructions
- Fast 8-bit by 8-bit multiply and 16-bit by 8-bit divide instructions
- STOP and WAIT instructions to invoke low-power operating modes

## 7.2 Programmer's Model and CPU Registers

Figure 7-1 shows the five CPU registers. CPU registers are not part of the memory map.



Figure 7-1. CPU Registers

### 7.2.1 Accumulator (A)

The A accumulator is a general-purpose 8-bit register. One operand input to the arithmetic logic unit (ALU) is connected to the accumulator and the ALU results are often stored into the A accumulator after arithmetic and logical operations. The accumulator can be loaded from memory using various addressing modes to specify the address where the loaded data comes from, or the contents of A can be stored to memory using various addressing modes to specify the address where data from A will be stored.

Reset has no effect on the contents of the A accumulator.

### 7.2.2 Index Register (H:X)

This 16-bit register is actually two separate 8-bit registers (H and X), which often work together as a 16-bit address pointer where H holds the upper byte of an address and X holds the lower byte of the address. All indexed addressing mode instructions use the full 16-bit value in H:X as an index reference pointer; however, for compatibility with the earlier M68HC05 Family, some instructions operate only on the low-order 8-bit half (X).

Many instructions treat X as a second general-purpose 8-bit register that can be used to hold 8-bit data values. X can be cleared, incremented, decremented, complemented, negated, shifted, or rotated. Transfer instructions allow data to be transferred from A or transferred to A where arithmetic and logical operations can then be performed.

For compatibility with the earlier M68HC05 Family, H is forced to 0x00 during reset. Reset has no effect on the contents of X.

### 7.2.3 Stack Pointer (SP)

This 16-bit address pointer register points at the next available location on the automatic last-in-first-out (LIFO) stack. The stack may be located anywhere in the 64-Kbyte address space that has RAM and can be any size up to the amount of available RAM. The stack is used to automatically save the return address for subroutine calls, the return address and CPU registers during interrupts, and for local variables. The AIS (add immediate to stack pointer) instruction adds an 8-bit signed immediate value to SP. This is most often used to allocate or deallocate space for local variables on the stack.

SP is forced to 0x00FF at reset for compatibility with the earlier M68HC05 Family. HCS08 programs normally change the value in SP to the address of the last location (highest address) in on-chip RAM during reset initialization to free up direct page RAM (from the end of the on-chip registers to 0x00FF).

The RSP (reset stack pointer) instruction was included for compatibility with the M68HC05 Family and is seldom used in new HCS08 programs because it only affects the low-order half of the stack pointer.

### 7.2.4 Program Counter (PC)

The program counter is a 16-bit register that contains the address of the next instruction or operand to be fetched.

During normal program execution, the program counter automatically increments to the next sequential memory location every time an instruction or operand is fetched. Jump, branch, interrupt, and return operations load the program counter with an address other than that of the next sequential location. This is called a change-of-flow.

During reset, the program counter is loaded with the reset vector that is located at 0xFFFFE and 0xFFFF. The vector stored there is the address of the first instruction that will be executed after exiting the reset state.

### 7.2.5 Condition Code Register (CCR)

The 8-bit condition code register contains the interrupt mask (I) and five flags that indicate the results of the instruction just executed. Bits 6 and 5 are set permanently to 1. The following paragraphs describe the functions of the condition code bits in general terms. For a more detailed explanation of how each instruction sets the CCR bits, refer to the *HCS08 Family Reference Manual, volume 1*, Freescale Semiconductor document order number HCS08RMv1.



Figure 7-2. Condition Code Register

Table 7-1. CCR Register Field Descriptions

Field	Description
7 V	<b>Two's Complement Overflow Flag</b> — The CPU sets the overflow flag when a two's complement overflow occurs. The signed branch instructions BGT, BGE, BLE, and BLT use the overflow flag. 0 No overflow 1 Overflow
4 H	<b>Half-Carry Flag</b> — The CPU sets the half-carry flag when a carry occurs between accumulator bits 3 and 4 during an add-without-carry (ADD) or add-with-carry (ADC) operation. The half-carry flag is required for binary-coded decimal (BCD) arithmetic operations. The DAA instruction uses the states of the H and C condition code bits to automatically add a correction value to the result from a previous ADD or ADC on BCD operands to correct the result to a valid BCD value. 0 No carry between bits 3 and 4 1 Carry between bits 3 and 4
3 I	<b>Interrupt Mask Bit</b> — When the interrupt mask is set, all maskable CPU interrupts are disabled. CPU interrupts are enabled when the interrupt mask is cleared. When a CPU interrupt occurs, the interrupt mask is set automatically after the CPU registers are saved on the stack, but before the first instruction of the interrupt service routine is executed. Interrupts are not recognized at the instruction boundary after any instruction that clears I (CLI or TAP). This ensures that the next instruction after a CLI or TAP will always be executed without the possibility of an intervening interrupt, provided I was set. 0 Interrupts enabled 1 Interrupts disabled
2 N	<b>Negative Flag</b> — The CPU sets the negative flag when an arithmetic operation, logic operation, or data manipulation produces a negative result, setting bit 7 of the result. Simply loading or storing an 8-bit or 16-bit value causes N to be set if the most significant bit of the loaded or stored value was 1. 0 Non-negative result 1 Negative result
1 Z	<b>Zero Flag</b> — The CPU sets the zero flag when an arithmetic operation, logic operation, or data manipulation produces a result of 0x00 or 0x0000. Simply loading or storing an 8-bit or 16-bit value causes Z to be set if the loaded or stored value was all 0s. 0 Non-zero result 1 Zero result
0 C	<b>Carry/Borrow Flag</b> — The CPU sets the carry/borrow flag when an addition operation produces a carry out of bit 7 of the accumulator or when a subtraction operation requires a borrow. Some instructions — such as bit test and branch, shift, and rotate — also clear or set the carry/borrow flag. 0 No carry out of bit 7 1 Carry out of bit 7



## 7.3 Addressing Modes

Addressing modes define the way the CPU accesses operands and data. In the HCS08, all memory, status and control registers, and input/output (I/O) ports share a single 64-Kbyte linear address space so a 16-bit binary address can uniquely identify any memory location. This arrangement means that the same instructions that access variables in RAM can also be used to access I/O and control registers or nonvolatile program space.

Some instructions use more than one addressing mode. For instance, move instructions use one addressing mode to specify the source operand and a second addressing mode to specify the destination address. Instructions such as BRCLR, BRSET, CBEQ, and DBNZ use one addressing mode to specify the location of an operand for a test and then use relative addressing mode to specify the branch destination address when the tested condition is true. For BRCLR, BRSET, CBEQ, and DBNZ, the addressing mode listed in the instruction set tables is the addressing mode needed to access the operand to be tested, and relative addressing mode is implied for the branch destination.

### 7.3.1 Inherent Addressing Mode (INH)

In this addressing mode, operands needed to complete the instruction (if any) are located within CPU registers so the CPU does not need to access memory to get any operands.

### 7.3.2 Relative Addressing Mode (REL)

Relative addressing mode is used to specify the destination location for branch instructions. A signed 8-bit offset value is located in the memory location immediately following the opcode. During execution, if the branch condition is true, the signed offset is sign-extended to a 16-bit value and is added to the current contents of the program counter, which causes program execution to continue at the branch destination address.

### 7.3.3 Immediate Addressing Mode (IMM)

In immediate addressing mode, the operand needed to complete the instruction is included in the object code immediately following the instruction opcode in memory. In the case of a 16-bit immediate operand, the high-order byte is located in the next memory location after the opcode, and the low-order byte is located in the next memory location after that.

### 7.3.4 Direct Addressing Mode (DIR)

In direct addressing mode, the instruction includes the low-order eight bits of an address in the direct page (0x0000–0x00FF). During execution a 16-bit address is formed by concatenating an implied 0x00 for the high-order half of the address and the direct address from the instruction to get the 16-bit address where the desired operand is located. This is faster and more memory efficient than specifying a complete 16-bit address for the operand.

### 7.3.5 Extended Addressing Mode (EXT)

In extended addressing mode, the full 16-bit address of the operand is located in the next two bytes of program memory after the opcode (high byte first).

### 7.3.6 Indexed Addressing Mode

Indexed addressing mode has seven variations including five that use the 16-bit H:X index register pair and two that use the stack pointer as the base reference.

#### 7.3.6.1 Indexed, No Offset (IX)

This variation of indexed addressing uses the 16-bit value in the H:X index register pair as the address of the operand needed to complete the instruction.

#### 7.3.6.2 Indexed, No Offset with Post Increment (IX+)

This variation of indexed addressing uses the 16-bit value in the H:X index register pair as the address of the operand needed to complete the instruction. The index register pair is then incremented ( $H:X = H:X + 0x0001$ ) after the operand has been fetched. This addressing mode is only used for MOV and CBEQ instructions.

#### 7.3.6.3 Indexed, 8-Bit Offset (IX1)

This variation of indexed addressing uses the 16-bit value in the H:X index register pair plus an unsigned 8-bit offset included in the instruction as the address of the operand needed to complete the instruction.

#### 7.3.6.4 Indexed, 8-Bit Offset with Post Increment (IX1+)

This variation of indexed addressing uses the 16-bit value in the H:X index register pair plus an unsigned 8-bit offset included in the instruction as the address of the operand needed to complete the instruction. The index register pair is then incremented ( $H:X = H:X + 0x0001$ ) after the operand has been fetched. This addressing mode is used only for the CBEQ instruction.

#### 7.3.6.5 Indexed, 16-Bit Offset (IX2)

This variation of indexed addressing uses the 16-bit value in the H:X index register pair plus a 16-bit offset included in the instruction as the address of the operand needed to complete the instruction.

#### 7.3.6.6 SP-Relative, 8-Bit Offset (SP1)

This variation of indexed addressing uses the 16-bit value in the stack pointer (SP) plus an unsigned 8-bit offset included in the instruction as the address of the operand needed to complete the instruction.

### 7.3.6.7 SP-Relative, 16-Bit Offset (SP2)

This variation of indexed addressing uses the 16-bit value in the stack pointer (SP) plus a 16-bit offset included in the instruction as the address of the operand needed to complete the instruction.

## 7.4 Special Operations

The CPU performs a few special operations that are similar to instructions but do not have opcodes like other CPU instructions. In addition, a few instructions such as STOP and WAIT directly affect other MCU circuitry. This section provides additional information about these operations.

### 7.4.1 Reset Sequence

Reset can be caused by a power-on-reset (POR) event, internal conditions such as the COP (computer operating properly) watchdog, or by assertion of an external active-low reset pin. When a reset event occurs, the CPU immediately stops whatever it is doing (the MCU does not wait for an instruction boundary before responding to a reset event). For a more detailed discussion about how the MCU recognizes resets and determines the source, refer to the [Resets, Interrupts, and System Configuration](#) chapter.

The reset event is considered concluded when the sequence to determine whether the reset came from an internal source is done and when the reset pin is no longer asserted. At the conclusion of a reset event, the CPU performs a 6-cycle sequence to fetch the reset vector from 0xFFFFE and 0xFFFF and to fill the instruction queue in preparation for execution of the first program instruction.

### 7.4.2 Interrupt Sequence

When an interrupt is requested, the CPU completes the current instruction before responding to the interrupt. At this point, the program counter is pointing at the start of the next instruction, which is where the CPU should return after servicing the interrupt. The CPU responds to an interrupt by performing the same sequence of operations as for a software interrupt (SWI) instruction, except the address used for the vector fetch is determined by the highest priority interrupt that is pending when the interrupt sequence started.

The CPU sequence for an interrupt is:

1. Store the contents of PCL, PCH, X, A, and CCR on the stack, in that order.
2. Set the I bit in the CCR.
3. Fetch the high-order half of the interrupt vector.
4. Fetch the low-order half of the interrupt vector.
5. Delay for one free bus cycle.
6. Fetch three bytes of program information starting at the address indicated by the interrupt vector to fill the instruction queue in preparation for execution of the first instruction in the interrupt service routine.

After the CCR contents are pushed onto the stack, the I bit in the CCR is set to prevent other interrupts while in the interrupt service routine. Although it is possible to clear the I bit with an instruction in the

interrupt service routine, this would allow nesting of interrupts (which is not recommended because it leads to programs that are difficult to debug and maintain).

For compatibility with the earlier M68HC05 MCUs, the high-order half of the H:X index register pair (H) is not saved on the stack as part of the interrupt sequence. The user must use a PSHH instruction at the beginning of the service routine to save H and then use a PULH instruction just before the RTI that ends the interrupt service routine. It is not necessary to save H if you are certain that the interrupt service routine does not use any instructions or auto-increment addressing modes that might change the value of H.

The software interrupt (SWI) instruction is like a hardware interrupt except that it is not masked by the global I bit in the CCR and it is associated with an instruction opcode within the program so it is not asynchronous to program execution.

### 7.4.3 Wait Mode Operation

The WAIT instruction enables interrupts by clearing the I bit in the CCR. It then halts the clocks to the CPU to reduce overall power consumption while the CPU is waiting for the interrupt or reset event that will wake the CPU from wait mode. When an interrupt or reset event occurs, the CPU clocks will resume and the interrupt or reset event will be processed normally.

If a serial BACKGROUND command is issued to the MCU through the background debug interface while the CPU is in wait mode, CPU clocks will resume and the CPU will enter active background mode where other serial background commands can be processed. This ensures that a host development system can still gain access to a target MCU even if it is in wait mode.

### 7.4.4 Stop Mode Operation

Usually, all system clocks, including the crystal oscillator (when used), are halted during stop mode to minimize power consumption. In such systems, external circuitry is needed to control the time spent in stop mode and to issue a signal to wake up the target MCU when it is time to resume processing. Unlike the earlier M68HC05 and M68HC08 MCUs, the HCS08 can be configured to keep a minimum set of clocks running in stop mode. This optionally allows an internal periodic signal to wake the target MCU from stop mode.

When a host debug system is connected to the background debug pin (BKGD) and the ENBDM control bit has been set by a serial command through the background interface (or because the MCU was reset into active background mode), the oscillator is forced to remain active when the MCU enters stop mode. In this case, if a serial BACKGROUND command is issued to the MCU through the background debug interface while the CPU is in stop mode, CPU clocks will resume and the CPU will enter active background mode where other serial background commands can be processed. This ensures that a host development system can still gain access to a target MCU even if it is in stop mode.

Recovery from stop mode depends on the particular HCS08 and whether the oscillator was stopped in stop mode. Refer to the [Modes of Operation](#) chapter for more details.

### 7.4.5 BGND Instruction

The BGND instruction is new to the HCS08 compared to the M68HC08. BGND would not be used in normal user programs because it forces the CPU to stop processing user instructions and enter the active background mode. The only way to resume execution of the user program is through reset or by a host debug system issuing a GO, TRACE1, or TAGGO serial command through the background debug interface.

Software-based breakpoints can be set by replacing an opcode at the desired breakpoint address with the BGND opcode. When the program reaches this breakpoint address, the CPU is forced to active background mode rather than continuing the user program.

## 7.5 HCS08 Instruction Set Summary

Table 7-2 provides a summary of the HCS08 instruction set in all possible addressing modes. The table shows operand construction, execution time in internal bus clock cycles, and cycle-by-cycle details for each addressing mode variation of each instruction.

Table 7-2. Instruction Set Summary (Sheet 1 of 9)

Source Form	Operation	Address Mode	Object Code	Cycles	Cyc-by-Cyc Details	Affect on CCR	
						V I 1 H	I N Z C
ADC #opr8i ADC opr8a ADC opr16a ADC oprx16,X ADC oprx8,X ADC ,X ADC oprx16,SP ADC oprx8,SP	Add with Carry $A \leftarrow (A) + (M) + (C)$	IMM DIR EXT IX2 IX1 IX SP2 SP1	A9 ii B9 dd C9 hh ll D9 ee ff E9 ff F9 9E D9 ee ff 9E E9 ff	2 3 4 4 3 3 5 4	pp rpp prpp prpp rpp rfp pprpp prpp	$\uparrow 1 1 \uparrow$	$- \uparrow \uparrow \uparrow$
ADD #opr8i ADD opr8a ADD opr16a ADD oprx16,X ADD oprx8,X ADD ,X ADD oprx16,SP ADD oprx8,SP	Add without Carry $A \leftarrow (A) + (M)$	IMM DIR EXT IX2 IX1 IX SP2 SP1	AB ii BB dd CB hh ll DB ee ff EB ff FB 9E DB ee ff 9E EB ff	2 3 4 4 3 3 5 4	pp rpp prpp prpp rpp rfp pprpp prpp	$\uparrow 1 1 \uparrow$	$- \uparrow \uparrow \uparrow$
AIS #opr8i	Add Immediate Value (Signed) to Stack Pointer $SP \leftarrow (SP) + (M)$	IMM	A7 ii	2	pp	- 1 1 -	- - - - -
AIX #opr8i	Add Immediate Value (Signed) to Index Register (H:X) $H:X \leftarrow (H:X) + (M)$	IMM	AF ii	2	pp	- 1 1 -	- - - - -
AND #opr8i AND opr8a AND opr16a AND oprx16,X AND oprx8,X AND ,X AND oprx16,SP AND oprx8,SP	Logical AND $A \leftarrow (A) \& (M)$	IMM DIR EXT IX2 IX1 IX SP2 SP1	A4 ii B4 dd C4 hh ll D4 ee ff E4 ff F4 9E D4 ee ff 9E E4 ff	2 3 4 4 3 3 5 4	pp rpp prpp prpp rpp rfp pprpp prpp	0 1 1 -	$- \uparrow \uparrow -$
ASL opr8a ASLA ASLX ASL oprx8,X ASL ,X ASL oprx8,SP	Arithmetic Shift Left  (Same as LSL)	DIR INH INH IX1 IX SP1	38 dd 48 58 68 ff 78 9E 68 ff	5 1 1 5 4 6	rfwpp p p rfwpp rfwp prfwpp	$\uparrow 1 1 -$	$- \uparrow \uparrow \uparrow$
ASR opr8a ASRA ASRX ASR oprx8,X ASR ,X ASR oprx8,SP	Arithmetic Shift Right 	DIR INH INH IX1 IX SP1	37 dd 47 57 67 ff 77 9E 67 ff	5 1 1 5 4 6	rfwpp p p rfwpp rfwp prfwpp	$\uparrow 1 1 -$	$- \uparrow \uparrow \uparrow$

Table 7-2. Instruction Set Summary (Sheet 2 of 9)

Source Form	Operation	Address Mode	Object Code	Cycles	Cyc-by-Cyc Details	Affect on CCR	
						V 1 1 H	I N Z C
BCC <i>rel</i>	Branch if Carry Bit Clear (if C = 0)	REL	24 rr	3	ppp	- 1 1 -	- - - - -
BCLR <i>n,opr8a</i>	Clear Bit n in Memory (Mn ← 0)	DIR (b0)	11 dd	5	rfwpp	- 1 1 -	- - - - -
		DIR (b1)	13 dd	5	rfwpp		
		DIR (b2)	15 dd	5	rfwpp		
		DIR (b3)	17 dd	5	rfwpp		
		DIR (b4)	19 dd	5	rfwpp		
		DIR (b5)	1B dd	5	rfwpp		
		DIR (b6)	1D dd	5	rfwpp		
DIR (b7)	1F dd	5	rfwpp				
BCS <i>rel</i>	Branch if Carry Bit Set (if C = 1) (Same as BLO)	REL	25 rr	3	ppp	- 1 1 -	- - - - -
BEQ <i>rel</i>	Branch if Equal (if Z = 1)	REL	27 rr	3	ppp	- 1 1 -	- - - - -
BGE <i>rel</i>	Branch if Greater Than or Equal To (if N ⊕ V = 0) (Signed)	REL	90 rr	3	ppp	- 1 1 -	- - - - -
BGND	Enter active background if ENBDM=1 Waits for and processes BDM commands until GO, TRACE1, or TAGGO	INH	82	5+	fp...ppp	- 1 1 -	- - - - -
BGT <i>rel</i>	Branch if Greater Than (if Z   (N ⊕ V) = 0) (Signed)	REL	92 rr	3	ppp	- 1 1 -	- - - - -
BHCC <i>rel</i>	Branch if Half Carry Bit Clear (if H = 0)	REL	28 rr	3	ppp	- 1 1 -	- - - - -
BHCS <i>rel</i>	Branch if Half Carry Bit Set (if H = 1)	REL	29 rr	3	ppp	- 1 1 -	- - - - -
BHI <i>rel</i>	Branch if Higher (if C   Z = 0)	REL	22 rr	3	ppp	- 1 1 -	- - - - -
BHS <i>rel</i>	Branch if Higher or Same (if C = 0) (Same as BCC)	REL	24 rr	3	ppp	- 1 1 -	- - - - -
BIH <i>rel</i>	Branch if IRQ Pin High (if IRQ pin = 1)	REL	2F rr	3	ppp	- 1 1 -	- - - - -
BIL <i>rel</i>	Branch if IRQ Pin Low (if IRQ pin = 0)	REL	2E rr	3	ppp	- 1 1 -	- - - - -
BIT # <i>opr8i</i> BIT <i>opr8a</i> BIT <i>opr16a</i> BIT <i>opr16,X</i> BIT <i>opr8,X</i> BIT <i>,X</i> BIT <i>opr16,SP</i> BIT <i>opr8,SP</i>	Bit Test (A) & (M) (CCR Updated but Operands Not Changed)	IMM DIR EXT IX2 IX1 IX SP2 SP1	A5 ii B5 dd C5 hh ll D5 ee ff E5 ff F5 9E D5 ee ff 9E E5 ff	2 3 4 4 3 3 5 4	pp rpp prpp prpp rpp rfp pprpp prpp	0 1 1 -	- ↑ ↓ -
BLE <i>rel</i>	Branch if Less Than or Equal To (if Z   (N ⊕ V) = 1) (Signed)	REL	93 rr	3	ppp	- 1 1 -	- - - - -
BLO <i>rel</i>	Branch if Lower (if C = 1) (Same as BCS)	REL	25 rr	3	ppp	- 1 1 -	- - - - -
BLS <i>rel</i>	Branch if Lower or Same (if C   Z = 1)	REL	23 rr	3	ppp	- 1 1 -	- - - - -
BLT <i>rel</i>	Branch if Less Than (if N ⊕ V = 1) (Signed)	REL	91 rr	3	ppp	- 1 1 -	- - - - -
BMC <i>rel</i>	Branch if Interrupt Mask Clear (if I = 0)	REL	2C rr	3	ppp	- 1 1 -	- - - - -
BMI <i>rel</i>	Branch if Minus (if N = 1)	REL	2B rr	3	ppp	- 1 1 -	- - - - -
BMS <i>rel</i>	Branch if Interrupt Mask Set (if I = 1)	REL	2D rr	3	ppp	- 1 1 -	- - - - -
BNE <i>rel</i>	Branch if Not Equal (if Z = 0)	REL	26 rr	3	ppp	- 1 1 -	- - - - -

Table 7-2. Instruction Set Summary (Sheet 3 of 9)

Source Form	Operation	Address Mode	Object Code	Cycles	Cyc-by-Cyc Details	Affect on CCR	
						V 1 1 H	I N Z C
BPL <i>rel</i>	Branch if Plus (if N = 0)	REL	2A rr	3	ppp	- 1 1 -	- - - -
BRA <i>rel</i>	Branch Always (if I = 1)	REL	20 rr	3	ppp	- 1 1 -	- - - -
BRCLR <i>n,opr8a,rel</i>	Branch if Bit <i>n</i> in Memory Clear (if (Mn) = 0)	DIR (b0) DIR (b1) DIR (b2) DIR (b3) DIR (b4) DIR (b5) DIR (b6) DIR (b7)	01 dd rr 03 dd rr 05 dd rr 07 dd rr 09 dd rr 0B dd rr 0D dd rr 0F dd rr	5 5 5 5 5 5 5 5	rpppp rpppp rpppp rpppp rpppp rpppp rpppp rpppp	- 1 1 -	- - - - ↓
BRN <i>rel</i>	Branch Never (if I = 0)	REL	21 rr	3	ppp	- 1 1 -	- - - -
BRSET <i>n,opr8a,rel</i>	Branch if Bit <i>n</i> in Memory Set (if (Mn) = 1)	DIR (b0) DIR (b1) DIR (b2) DIR (b3) DIR (b4) DIR (b5) DIR (b6) DIR (b7)	00 dd rr 02 dd rr 04 dd rr 06 dd rr 08 dd rr 0A dd rr 0C dd rr 0E dd rr	5 5 5 5 5 5 5 5	rpppp rpppp rpppp rpppp rpppp rpppp rpppp rpppp	- 1 1 -	- - - - ↓
BSET <i>n,opr8a</i>	Set Bit <i>n</i> in Memory (Mn ← 1)	DIR (b0) DIR (b1) DIR (b2) DIR (b3) DIR (b4) DIR (b5) DIR (b6) DIR (b7)	10 dd 12 dd 14 dd 16 dd 18 dd 1A dd 1C dd 1E dd	5 5 5 5 5 5 5 5	rffpp rffpp rffpp rffpp rffpp rffpp rffpp rffpp	- 1 1 -	- - - -
BSR <i>rel</i>	Branch to Subroutine PC ← (PC) + \$0002 push (PCL); SP ← (SP) - \$0001 push (PCH); SP ← (SP) - \$0001 PC ← (PC) + <i>rel</i>	REL	AD rr	5	ssppp	- 1 1 -	- - - -
CBEQ <i>opr8a,rel</i> CBEQA # <i>opr8i,rel</i> CBEQX # <i>opr8i,rel</i> CBEQ <i>opr8,X+,rel</i> CBEQ <i>,X+,rel</i> CBEQ <i>opr8,SP,rel</i>	Compare and... Branch if (A) = (M) Branch if (A) = (M) Branch if (X) = (M) Branch if (A) = (M) Branch if (A) = (M) Branch if (A) = (M)	DIR IMM IMM IX1+ IX+ SP1	31 dd rr 41 ii rr 51 ii rr 61 ff rr 71 rr 9E 61 ff rr	5 4 4 5 5 6	rpppp pppp pppp rpppp rfppp prpppp	- 1 1 -	- - - -
CLC	Clear Carry Bit (C ← 0)	INH	98	1	p	- 1 1 -	- - - 0
CLI	Clear Interrupt Mask Bit (I ← 0)	INH	9A	1	p	- 1 1 -	0 - - -
CLR <i>opr8a</i> CLRA CLR X CLR H CLR <i>opr8,X</i> CLR <i>,X</i> CLR <i>opr8,SP</i>	Clear M ← \$00 A ← \$00 X ← \$00 H ← \$00 M ← \$00 M ← \$00 M ← \$00	DIR INH INH INH IX1 IX SP1	3F dd 4F 5F 8C 6F ff 7F 9E 6F ff	5 1 1 1 5 4 6	rffpp p p p rffpp rffpp prffpp	0 1 1 -	- 0 1 -

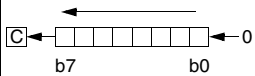
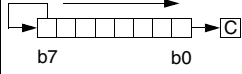

Table 7-2. Instruction Set Summary (Sheet 4 of 9)

Source Form	Operation	Address Mode	Object Code	Cycles	Cyc-by-Cyc Details	Affect on CCR	
						V 1 1 H	I N Z C
CMP #opr8i CMP opr8a CMP opr16a CMP oprx16,X CMP oprx8,X CMP ,X CMP oprx16,SP CMP oprx8,SP	Compare Accumulator with Memory A – M (CCR Updated But Operands Not Changed)	IMM DIR EXT IX2 IX1 IX SP2 SP1	A1 ii B1 dd C1 hh ll D1 ee ff E1 ff F1 9E D1 ee ff 9E E1 ff	2 3 4 4 3 3 5 4	pp rpp prpp prpp rpp rfp pprpp prpp	↑ 1 1 –	– ↓ ↓ ↓
COM opr8a COMA COMX COM oprx8,X COM ,X COM oprx8,SP	Complement (One's Complement) $M \leftarrow (\overline{M}) = \$FF - (M)$ $A \leftarrow (\overline{A}) = \$FF - (A)$ $X \leftarrow (\overline{X}) = \$FF - (X)$ $M \leftarrow (\overline{M}) = \$FF - (M)$ $M \leftarrow (\overline{M}) = \$FF - (M)$ $M \leftarrow (\overline{M}) = \$FF - (M)$	DIR INH INH IX1 IX SP1	33 dd 43 53 63 ff 73 9E 63 ff	5 1 1 5 4 6	rfwpp p p rfwpp rfwp prfwpp	0 1 1 –	– ↓ ↓ ↓
CPHX opr16a CPHX #opr16i CPHX opr8a CPHX oprx8,SP	Compare Index Register (H:X) with Memory (H:X) – (M:M + \$0001) (CCR Updated But Operands Not Changed)	EXT IMM DIR SP1	3E hh ll 65 jj kk 75 dd 9E F3 ff	6 3 5 6	prrfpp ppp rrfpp prrfpp	↑ 1 1 –	– ↓ ↓ ↓
CPX #opr8i CPX opr8a CPX opr16a CPX oprx16,X CPX oprx8,X CPX ,X CPX oprx16,SP CPX oprx8,SP	Compare X (Index Register Low) with Memory X – M (CCR Updated But Operands Not Changed)	IMM DIR EXT IX2 IX1 IX SP2 SP1	A3 ii B3 dd C3 hh ll D3 ee ff E3 ff F3 9E D3 ee ff 9E E3 ff	2 3 4 4 3 3 5 4	pp rpp prpp prpp rpp rfp pprpp prpp	↑ 1 1 –	– ↓ ↓ ↓
DAA	Decimal Adjust Accumulator After ADD or ADC of BCD Values	INH	72	1	p	U 1 1 –	– ↓ ↓ ↓
DBNZ opr8a,rel DBNZA rel DBNZX rel DBNZ oprx8,X,rel DBNZ ,X,rel DBNZ oprx8,SP,rel	Decrement A, X, or M and Branch if Not Zero (if (result) ≠ 0) DBNZX Affects X Not H	DIR INH INH IX1 IX SP1	3B dd rr 4B rr 5B rr 6B ff rr 7B rr 9E 6B ff rr	7 4 4 7 6 8	rfwpppp fppp fppp rfwpppp rfwppp prfwpppp	– 1 1 –	– – – –
DEC opr8a DECA DECX DEC oprx8,X DEC ,X DEC oprx8,SP	Decrement $M \leftarrow (M) - \$01$ $A \leftarrow (A) - \$01$ $X \leftarrow (X) - \$01$ $M \leftarrow (M) - \$01$ $M \leftarrow (M) - \$01$ $M \leftarrow (M) - \$01$	DIR INH INH IX1 IX SP1	3A dd 4A 5A 6A ff 7A 9E 6A ff	5 1 1 5 4 6	rfwpp p p rfwpp rfwp prfwpp	↑ 1 1 –	– ↓ ↓ –
DIV	Divide $A \leftarrow (H:A) \div (X)$ ; H ← Remainder	INH	52	6	fffffp	– 1 1 –	– – ↓ ↓
EOR #opr8i EOR opr8a EOR opr16a EOR oprx16,X EOR oprx8,X EOR ,X EOR oprx16,SP EOR oprx8,SP	Exclusive OR Memory with Accumulator $A \leftarrow (A \oplus M)$	IMM DIR EXT IX2 IX1 IX SP2 SP1	A8 ii B8 dd C8 hh ll D8 ee ff E8 ff F8 9E D8 ee ff 9E E8 ff	2 3 4 4 3 3 5 4	pp rpp prpp prpp rpp rfp pprpp prpp	0 1 1 –	– ↓ ↓ –

Table 7-2. Instruction Set Summary (Sheet 5 of 9)

Source Form	Operation	Address Mode	Object Code	Cycles	Cyc-by-Cyc Details	Affect on CCR	
						V 1 1 H	I N Z C
INC <i>opr8a</i> INCA INCX INC <i>opr8,X</i> INC ,X INC <i>opr8,SP</i>	Increment $M \leftarrow (M) + \$01$ $A \leftarrow (A) + \$01$ $X \leftarrow (X) + \$01$ $M \leftarrow (M) + \$01$ $M \leftarrow (M) + \$01$	DIR INH INH IX1 IX SP1	3C dd 4C 5C 6C ff 7C 9E 6C ff	5 1 1 5 4 6	r#wpp p p r#wpp r#wp pr#wpp		
JMP <i>opr8a</i> JMP <i>opr16a</i> JMP <i>opr16,X</i> JMP <i>opr8,X</i> JMP ,X	Jump $PC \leftarrow \text{Jump Address}$	DIR EXT IX2 IX1 IX	BC dd CC hh ll DC ee ff EC ff FC	3 4 4 3 3	ppp pppp pppp ppp ppp	- 1 1 -	- - - - -
JSR <i>opr8a</i> JSR <i>opr16a</i> JSR <i>opr16,X</i> JSR <i>opr8,X</i> JSR ,X	Jump to Subroutine $PC \leftarrow (PC) + n$ ( $n = 1, 2, \text{ or } 3$ ) Push (PCL); $SP \leftarrow (SP) - \$0001$ Push (PCH); $SP \leftarrow (SP) - \$0001$ $PC \leftarrow \text{Unconditional Address}$	DIR EXT IX2 IX1 IX	BD dd CD hh ll DD ee ff ED ff FD	5 6 6 5 5	ssppp psppp psppp ssppp ssppp	- 1 1 -	- - - - -
LDA # <i>opr8i</i> LDA <i>opr8a</i> LDA <i>opr16a</i> LDA <i>opr16,X</i> LDA <i>opr8,X</i> LDA ,X LDA <i>opr16,SP</i> LDA <i>opr8,SP</i>	Load Accumulator from Memory $A \leftarrow (M)$	IMM DIR EXT IX2 IX1 IX SP2 SP1	A6 ii B6 dd C6 hh ll D6 ee ff E6 ff F6 9E D6 ee ff 9E E6 ff	2 3 4 4 3 3 5 4	pp rpp prpp prpp rpp rfp pprpp prpp	0 1 1 -	- $\uparrow \downarrow$ -
LDHX # <i>opr16i</i> LDHX <i>opr8a</i> LDHX <i>opr16a</i> LDHX ,X LDHX <i>opr16,X</i> LDHX <i>opr8,X</i> LDHX <i>opr8,SP</i>	Load Index Register (H:X) $H:X \leftarrow (M:M + \$0001)$	IMM DIR EXT IX IX2 IX1 SP1	45 jj kk 55 dd 32 hh ll 9E AE 9E BE ee ff 9E CE ff 9E FE ff	3 4 5 5 6 5 5	ppp rrpp prpp prrfp pprrpp prpp prpp	0 1 1 -	- $\uparrow \downarrow$ -
LDX # <i>opr8i</i> LDX <i>opr8a</i> LDX <i>opr16a</i> LDX <i>opr16,X</i> LDX <i>opr8,X</i> LDX ,X LDX <i>opr16,SP</i> LDX <i>opr8,SP</i>	Load X (Index Register Low) from Memory $X \leftarrow (M)$	IMM DIR EXT IX2 IX1 IX SP2 SP1	AE ii BE dd CE hh ll DE ee ff EE ff FE 9E DE ee ff 9E EE ff	2 3 4 4 3 3 5 4	pp rpp prpp prpp rpp rfp pprpp prpp	0 1 1 -	- $\uparrow \downarrow$ -
LSL <i>opr8a</i> LSLA LSLX LSL <i>opr8,X</i> LSL ,X LSL <i>opr8,SP</i>	Logical Shift Left  (Same as ASL)	DIR INH INH IX1 IX SP1	38 dd 48 58 68 ff 78 9E 68 ff	5 1 1 5 4 6	r#wpp p p r#wpp r#wp pr#wpp	$\uparrow$ 1 1 -	- $\uparrow \downarrow \downarrow$
LSR <i>opr8a</i> LSRA LSRX LSR <i>opr8,X</i> LSR ,X LSR <i>opr8,SP</i>	Logical Shift Right 	DIR INH INH IX1 IX SP1	34 dd 44 54 64 ff 74 9E 64 ff	5 1 1 5 4 6	r#wpp p p r#wpp r#wp pr#wpp	$\uparrow$ 1 1 -	- 0 $\uparrow \downarrow$

Table 7-2. Instruction Set Summary (Sheet 6 of 9)

Source Form	Operation	Address Mode	Object Code	Cycles	Cyc-by-Cyc Details	Affect on CCR	
						V 1 1 H	I N Z C
MOV <i>opr8a,opr8a</i> MOV <i>opr8a,X+</i> MOV <i>#opr8i,opr8a</i> MOV <i>,X+,opr8a</i>	Move $(M)_{\text{destination}} \leftarrow (M)_{\text{source}}$ In IX+/DIR and DIR/IX+ Modes, $H:X \leftarrow (H:X) + \$0001$	DIR/DIR DIR/IX+ IMM/DIR IX+/DIR	4E dd dd 5E dd 6E ii dd 7E dd	5 5 4 5	rpwpp rfwpp pwpp rfwpp	0 1 1 -	- $\uparrow$ $\downarrow$ $\uparrow$ -
MUL	Unsigned multiply $X:A \leftarrow (X) \times (A)$	INH	42	5	fffffp	- 1 1 0	- - - - 0
NEG <i>opr8a</i> NEGA NEGX NEG <i>oprx8,X</i> NEG <i>,X</i> NEG <i>oprx8,SP</i>	Negate (Two's Complement) $M \leftarrow -(M) = \$00 - (M)$ $A \leftarrow -(A) = \$00 - (A)$ $X \leftarrow -(X) = \$00 - (X)$ $M \leftarrow -(M) = \$00 - (M)$ $M \leftarrow -(M) = \$00 - (M)$ $M \leftarrow -(M) = \$00 - (M)$	DIR INH INH IX1 IX SP1	30 dd 40 50 60 ff 70 9E 60 ff	5 1 1 5 4 6	rfwpp p p rfwpp rfwp prfwpp	$\uparrow$ 1 1 -	- $\uparrow$ $\downarrow$ $\uparrow$ $\downarrow$
NOP	No Operation — Uses 1 Bus Cycle	INH	9D	1	p	- 1 1 -	- - - - -
NSA	Nibble Swap Accumulator $A \leftarrow (A[3:0]:A[7:4])$	INH	62	1	p	- 1 1 -	- - - - -
ORA <i>#opr8i</i> ORA <i>opr8a</i> ORA <i>opr16a</i> ORA <i>oprx16,X</i> ORA <i>oprx8,X</i> ORA <i>,X</i> ORA <i>oprx16,SP</i> ORA <i>oprx8,SP</i>	Inclusive OR Accumulator and Memory $A \leftarrow (A) \mid (M)$	IMM DIR EXT IX2 IX1 IX SP2 SP1	AA ii BA dd CA hh ll DA ee ff EA ff FA 9E DA ee ff 9E EA ff	2 3 4 4 3 3 5 4	pp rpp prpp prpp rpp rfp pprpp prpp	0 1 1 -	- $\uparrow$ $\downarrow$ $\uparrow$ -
PSHA	Push Accumulator onto Stack Push (A); $SP \leftarrow (SP) - \$0001$	INH	87	2	sp	- 1 1 -	- - - - -
PSHH	Push H (Index Register High) onto Stack Push (H); $SP \leftarrow (SP) - \$0001$	INH	8B	2	sp	- 1 1 -	- - - - -
PSHX	Push X (Index Register Low) onto Stack Push (X); $SP \leftarrow (SP) - \$0001$	INH	89	2	sp	- 1 1 -	- - - - -
PULA	Pull Accumulator from Stack $SP \leftarrow (SP + \$0001)$ ; Pull (A)	INH	86	3	ufp	- 1 1 -	- - - - -
PULH	Pull H (Index Register High) from Stack $SP \leftarrow (SP + \$0001)$ ; Pull (H)	INH	8A	3	ufp	- 1 1 -	- - - - -
PULX	Pull X (Index Register Low) from Stack $SP \leftarrow (SP + \$0001)$ ; Pull (X)	INH	88	3	ufp	- 1 1 -	- - - - -
ROL <i>opr8a</i> ROLA ROLX ROL <i>oprx8,X</i> ROL <i>,X</i> ROL <i>oprx8,SP</i>	Rotate Left through Carry 	DIR INH INH IX1 IX SP1	39 dd 49 59 69 ff 79 9E 69 ff	5 1 1 5 4 6	rfwpp p p rfwpp rfwp prfwpp	$\uparrow$ 1 1 -	- $\uparrow$ $\downarrow$ $\uparrow$ $\downarrow$
ROR <i>opr8a</i> RORA RORX ROR <i>oprx8,X</i> ROR <i>,X</i> ROR <i>oprx8,SP</i>	Rotate Right through Carry 	DIR INH INH IX1 IX SP1	36 dd 46 56 66 ff 76 9E 66 ff	5 1 1 5 4 6	rfwpp p p rfwpp rfwp prfwpp	$\uparrow$ 1 1 -	- $\uparrow$ $\downarrow$ $\uparrow$ $\downarrow$

Table 7-2. Instruction Set Summary (Sheet 7 of 9)

Source Form	Operation	Address Mode	Object Code	Cycles	Cyc-by-Cyc Details	Affect on CCR	
						V 1 1 H	I N Z C
RSP	Reset Stack Pointer (Low Byte) SPL ← \$FF (High Byte Not Affected)	INH	9C	1	p	- 1 1 -	- - - - -
RTI	Return from Interrupt SP ← (SP) + \$0001; Pull (CCR) SP ← (SP) + \$0001; Pull (A) SP ← (SP) + \$0001; Pull (X) SP ← (SP) + \$0001; Pull (PCH) SP ← (SP) + \$0001; Pull (PCL)	INH	80	9	uuuuufppp	↑ 1 1 ↓	↑ ↓ ↑ ↓
RTS	Return from Subroutine SP ← SP + \$0001; Pull (PCH) SP ← SP + \$0001; Pull (PCL)	INH	81	5	ufppp	- 1 1 -	- - - - -
SBC #opr8i SBC opr8a SBC opr16a SBC oprx16,X SBC oprx8,X SBC ,X SBC oprx16,SP SBC oprx8,SP	Subtract with Carry A ← (A) – (M) – (C)	IMM DIR EXT IX2 IX1 IX SP2 SP1	A2 ii B2 dd C2 hh ll D2 ee ff E2 ff F2 9E D2 ee ff 9E E2 ff	2 3 4 4 3 3 5 4	pp rpp prpp prpp rpp rff pprpp prpp	↑ 1 1 -	- ↓ ↑ ↓
SEC	Set Carry Bit (C ← 1)	INH	99	1	p	- 1 1 -	- - - - 1
SEI	Set Interrupt Mask Bit (I ← 1)	INH	9B	1	p	- 1 1 -	1 - - - -
STA opr8a STA opr16a STA oprx16,X STA oprx8,X STA ,X STA oprx16,SP STA oprx8,SP	Store Accumulator in Memory M ← (A)	DIR EXT IX2 IX1 IX SP2 SP1	B7 dd C7 hh ll D7 ee ff E7 ff F7 9E D7 ee ff 9E E7 ff	3 4 4 3 2 5 4	wpp pwpp pwpp wpp wp ppwpp pwpp	0 1 1 -	- ↓ ↑ ↓ -
STHX opr8a STHX opr16a STHX oprx8,SP	Store H:X (Index Reg.) (M:M + \$0001) ← (H:X)	DIR EXT SP1	35 dd 96 hh ll 9E FF ff	4 5 5	wpp pwpp pwpp	0 1 1 -	- ↓ ↑ ↓ -
STOP	Enable Interrupts: Stop Processing Refer to MCU Documentation I bit ← 0; Stop Processing	INH	8E	2	fp...	- 1 1 -	0 - - - -
STX opr8a STX opr16a STX oprx16,X STX oprx8,X STX ,X STX oprx16,SP STX oprx8,SP	Store X (Low 8 Bits of Index Register) in Memory M ← (X)	DIR EXT IX2 IX1 IX SP2 SP1	BF dd CF hh ll DF ee ff EF ff FF 9E DF ee ff 9E EF ff	3 4 4 3 2 5 4	wpp pwpp pwpp wpp wp ppwpp pwpp	0 1 1 -	- ↓ ↑ ↓ -

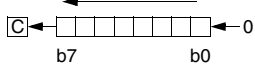
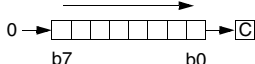
Table 7-2. Instruction Set Summary (Sheet 8 of 9)

Source Form	Operation	Address Mode	Object Code	Cycles	Cyc-by-Cyc Details	Affect on CCR	
						V 1 1 H	I N Z C
SUB #opr8i SUB opr8a SUB opr16a SUB oprx16,X SUB oprx8,X SUB ,X SUB oprx16,SP SUB oprx8,SP	Subtract $A \leftarrow (A) - (M)$	IMM DIR EXT IX2 IX1 IX SP2 SP1	A0 ii E0 dd C0 hh ll D0 ee ff E0 ff F0 9E D0 ee ff 9E E0 ff	2 3 4 4 3 3 5 4	pp rpp prpp prpp rpp rfp pprpp prpp		
SWI	Software Interrupt $PC \leftarrow (PC) + \$0001$ Push (PCL); $SP \leftarrow (SP) - \$0001$ Push (PCH); $SP \leftarrow (SP) - \$0001$ Push (X); $SP \leftarrow (SP) - \$0001$ Push (A); $SP \leftarrow (SP) - \$0001$ Push (CCR); $SP \leftarrow (SP) - \$0001$ $I \leftarrow 1$ ; PCH ← Interrupt Vector High Byte PCL ← Interrupt Vector Low Byte	INH	83	11	sssssvvfppp	- 1 1 -	1 - - -
TAP	Transfer Accumulator to CCR $CCR \leftarrow (A)$	INH	84	1	p	↑ 1 1 ↑	↑ ↑ ↑ ↑
TAX	Transfer Accumulator to X (Index Register Low) $X \leftarrow (A)$	INH	97	1	p	- 1 1 -	- - - -
TPA	Transfer CCR to Accumulator $A \leftarrow (CCR)$	INH	85	1	p	- 1 1 -	- - - -
TST opr8a TSTA TSTX TST oprx8,X TST ,X TST oprx8,SP	Test for Negative or Zero (M) – \$00 (A) – \$00 (X) – \$00 (M) – \$00 (M) – \$00 (M) – \$00	DIR INH INH IX1 IX SP1	3D dd 4D 5D 6D ff 7D 9E 6D ff	4 1 1 4 3 5	rfpp p p rfpp rfp prfpp	0 1 1 -	- ↓ ↑ -
TSX	Transfer SP to Index Reg. $H:X \leftarrow (SP) + \$0001$	INH	95	2	fp	- 1 1 -	- - - -
TXA	Transfer X (Index Reg. Low) to Accumulator $A \leftarrow (X)$	INH	9F	1	p	- 1 1 -	- - - -

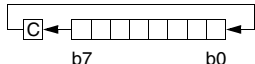
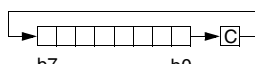
Table 7-2. Instruction Set Summary (Sheet 9 of 9)

Source Form	Operation	Address Mode	Object Code	Cycles	Cyc-by-Cyc Details	Affect on CCR	
						V 1 1 H	I N Z C
TXS	Transfer Index Reg. to SP SP ← (H:X) – \$0001	INH	94	2	fp	- 1 1 -	- - - -
WAIT	Enable Interrupts; Wait for Interrupt I bit ← 0; Halt CPU	INH	8F	2+	fp . . .	- 1 1 -	0 - - -

**Source Form:** Everything in the source forms columns, *except expressions in italic characters*, is literal information which must appear in the assembly source file exactly as shown. The initial 3- to 5-letter mnemonic and the characters (#, ( ) and +) are always a literal characters.

- n* Any label or expression that evaluates to a single integer in the range 0-7.
- opr8i* Any label or expression that evaluates to an 8-bit immediate value.
- opr16i* Any label or expression that evaluates to a 16-bit immediate value.
- opr8a* Any label or expression that evaluates to an 8-bit direct-page address (\$00xx).
- opr16a* Any label or expression that evaluates to a 16-bit address.
- opr8* Any label or expression that evaluates to an unsigned 8-bit value, used for indexed addressing.
- opr16* Any label or expression that evaluates to a 16-bit value, used for indexed addressing.
- rel* Any label or expression that refers to an address that is within –128 to +127 locations from the start of the next instruction.

**Operation Symbols:**

- A Accumulator
- CCR Condition code register
- H Index register high byte
- M Memory location
- n* Any bit
- opr* Operand (one or two bytes)
- PC Program counter
- PCH Program counter high byte
- PCL Program counter low byte
- rel* Relative program counter offset byte
- SP Stack pointer
- SPL Stack pointer low byte
- X Index register low byte
- & Logical AND
- | Logical OR
- ⊕ Logical EXCLUSIVE OR
- ( ) Contents of
- + Add
- Subtract, Negation (two’s complement)
- × Multiply
- ÷ Divide
- # Immediate value
- ← Loaded with
- :

**CCR Bits:**

- V Overflow bit
- H Half-carry bit
- I Interrupt mask
- N Negative bit
- Z Zero bit
- C Carry/borrow bit

**Addressing Modes:**

- DIR Direct addressing mode
- EXT Extended addressing mode
- IMM Immediate addressing mode
- INH Inherent addressing mode
- IX Indexed, no offset addressing mode
- IX1 Indexed, 8-bit offset addressing mode
- IX2 Indexed, 16-bit offset addressing mode
- IX+ Indexed, no offset, post increment addressing mode
- IX1+ Indexed, 8-bit offset, post increment addressing mode
- REL Relative addressing mode
- SP1 Stack pointer, 8-bit offset addressing mode
- SP2 Stack pointer 16-bit offset addressing mode

**Cycle-by-Cycle Codes:**

- f Free cycle. This indicates a cycle where the CPU does not require use of the system buses. An f cycle is always one cycle of the system bus clock and is always a read cycle.
- p Program fetch; read from next consecutive location in program memory
- r Read 8-bit operand
- s Push (write) one byte onto stack
- u Pop (read) one byte from stack
- v Read vector from \$FFxx (high byte first)
- w Write 8-bit operand

**CCR Effects:**

- ↑ Set or cleared
- Not affected
- U Undefined

Table 7-3. Opcode Map (Sheet 1 of 2)

Bit-Manipulation		Branch		Read-Modify-Write				Control				Register/Memory					
00 BRSET0 3 DIR	10 BSET0 2 DIR	20 BRA 2 REL	30 NEG 2 DIR	40 NEGA 1 INH	50 NEGX 1 INH	60 NEG 2 IX1	70 NEG 1 IX	80 RTI 1 INH	90 BGE 2 REL	A0 SUB 2 IMM	B0 SUB 2 DIR	C0 SUB 3 EXT	D0 SUB 3 IX2	E0 SUB 2 IX1	F0 SUB 1 IX		
01 BRCLR0 3 DIR	11 BCLR0 2 DIR	21 BRN 2 REL	31 CBEQ 3 DIR	41 CBEQA 3 IMM	51 CBEQX 3 IMM	61 CBEQ 3 IX1+	71 CBEQ 2 IX+	81 RTS 1 INH	91 BLT 2 REL	A1 CMP 2 IMM	B1 CMP 2 DIR	C1 CMP 3 EXT	D1 CMP 3 IX2	E1 CMP 2 IX1	F1 CMP 1 IX		
02 BRSET1 3 DIR	12 BSET1 2 DIR	22 BHI 2 REL	32 LDHX 3 EXT	42 MUL 1 INH	52 DIV 6	62 NSA 1 INH	72 DAA 1 INH	82 BGND 5+ 1 INH	92 BGT 2 REL	A2 SBC 2 IMM	B2 SBC 2 DIR	C2 SBC 3 EXT	D2 SBC 3 IX2	E2 SBC 2 IX1	F2 SBC 1 IX		
03 BRCLR1 3 DIR	13 BCLR1 2 DIR	23 BLS 2 REL	33 COM 2 DIR	43 COMA 1 INH	53 COMX 1 INH	63 COM 2 IX1	73 COM 1 IX	83 SWI 1 INH	93 BLE 2 REL	A3 CPX 2 IMM	B3 CPX 2 DIR	C3 CPX 3 EXT	D3 CPX 3 IX2	E3 CPX 2 IX1	F3 CPX 1 IX		
04 BRSET2 3 DIR	14 BSET2 2 DIR	24 BCC 2 REL	34 LSR 2 DIR	44 LSRA 1 INH	54 LSRX 1 INH	64 LSR 2 IX1	74 LSR 1 IX	84 TAP 1 INH	94 TXS 1 INH	A4 AND 2 IMM	B4 AND 2 DIR	C4 AND 3 EXT	D4 AND 3 IX2	E4 AND 2 IX1	F4 AND 1 IX		
05 BRCLR2 3 DIR	15 BCLR2 2 DIR	25 BCS 2 REL	35 STHX 2 DIR	45 LDHX 3 IMM	55 LDHX 2 DIR	65 CPHX 3 IMM	75 CPHX 2 DIR	85 TPA 1 INH	95 TSX 1 INH	A5 BIT 2 IMM	B5 BIT 2 DIR	C5 BIT 3 EXT	D5 BIT 3 IX2	E5 BIT 2 IX1	F5 BIT 1 IX		
06 BRSET3 3 DIR	16 BSET3 2 DIR	26 BNE 2 REL	36 ROR 2 DIR	46 RORA 1 INH	56 RORX 1 INH	66 ROR 2 IX1	76 ROR 1 IX	86 PULA 1 INH	96 STHX 3 EXT	A6 LDA 2 IMM	B6 LDA 2 DIR	C6 LDA 3 EXT	D6 LDA 3 IX2	E6 LDA 2 IX1	F6 LDA 1 IX		
07 BRCLR3 3 DIR	17 BCLR3 2 DIR	27 BEQ 2 REL	37 ASR 2 DIR	47 ASRA 1 INH	57 ASRX 1 INH	67 ASR 2 IX1	77 ASR 1 IX	87 PSHA 1 INH	97 TAX 1 INH	A7 AIS 2 IMM	B7 STA 2 DIR	C7 STA 3 EXT	D7 STA 3 IX2	E7 STA 2 IX1	F7 STA 1 IX		
08 BRSET4 3 DIR	18 BSET4 2 DIR	28 BHCC 2 REL	38 LSL 2 DIR	48 LSLA 1 INH	58 LSLX 1 INH	68 LSL 2 IX1	78 LSL 1 IX	88 PULX 1 INH	98 CLC 1 INH	A8 EOR 2 IMM	B8 EOR 2 DIR	C8 EOR 3 EXT	D8 EOR 3 IX2	E8 EOR 2 IX1	F8 EOR 1 IX		
09 BRCLR4 3 DIR	19 BCLR4 2 DIR	29 BHCS 2 REL	39 ROL 2 DIR	49 ROLA 1 INH	59 ROLX 1 INH	69 ROL 2 IX1	79 ROL 1 IX	89 PSHX 1 INH	99 SEC 1 INH	A9 ADC 2 IMM	B9 ADC 2 DIR	C9 ADC 3 EXT	D9 ADC 3 IX2	E9 ADC 2 IX1	F9 ADC 1 IX		
0A BRSET5 3 DIR	1A BSET5 2 DIR	2A BPL 2 REL	3A DEC 2 DIR	4A DECA 1 INH	5A DECX 1 INH	6A DEC 2 IX1	7A DEC 1 IX	8A PULH 1 INH	9A CLI 1 INH	AA ORA 2 IMM	BA ORA 2 DIR	CA ORA 3 EXT	DA ORA 3 IX2	EA ORA 2 IX1	FA ORA 1 IX		
0B BRCLR5 3 DIR	1B BCLR5 2 DIR	2B BBI 2 REL	3B DBNZ 3 DIR	4B DBNZA 2 INH	5B DBNZX 2 INH	6B DBNZ 3 IX1	7B DBNZ 2 IX	8B PSHH 1 INH	9B SEI 1 INH	AB ADD 2 IMM	BB ADD 2 DIR	CB ADD 3 EXT	DB ADD 3 IX2	EB ADD 2 IX1	FB ADD 1 IX		
0C BRSET6 3 DIR	1C BSET6 2 DIR	2C BMC 2 REL	3C INC 2 DIR	4C INCA 1 INH	5C INCX 1 INH	6C INC 2 IX1	7C INC 1 IX	8C CLRH 1 INH	9C RSP 1 INH	BC JMP 2 DIR	CC JMP 3 EXT	DC JMP 3 IX2	EC JMP 2 IX1	FC JMP 1 IX			
0D BRCLR6 3 DIR	1D BCLR6 2 DIR	2D BMS 2 REL	3D TST 2 DIR	4D TSTA 1 INH	5D TSTX 1 INH	6D TST 2 IX1	7D TST 1 IX	8D STOP 2+ 1 INH	9D NOP 1 INH	AD BSR 2 REL	BD JSR 2 DIR	CD JSR 3 EXT	DD JSR 3 IX2	ED JSR 2 IX1	FD JSR 1 IX		
0E BRSET7 3 DIR	1E BSET7 2 DIR	2E BIL 2 REL	3E CPHX 3 EXT	4E MOV 3 DD	5E MOV 2 DIX+	6E MOV 3 IMD	7E MOV 2 IX+D	8E WAIT 2+ 1 INH	9E TXA 1 INH	AE LDX 2 IMM	BE LDX 2 DIR	CE LDX 3 EXT	DE LDX 3 IX2	EE LDX 2 IX1	FE LDX 1 IX		
0F BRCLR7 3 DIR	1F BCLR7 2 DIR	2F BIH 2 REL	3F CLR 2 DIR	4F CLRA 1 INH	5F CLR 1 INH	6F CLR 2 IX1	7F CLR 1 IX	8F WAIT 2+ 1 INH	9F TXA 1 INH	AF AIX 2 IMM	BF STX 2 DIR	CF STX 3 EXT	DF STX 3 IX2	EF STX 2 IX1	FF STX 1 IX		

INH Inherent  
 IMM Immediate  
 DIR Direct  
 EXT Extended  
 DD DIR to DIR  
 IX+D IX+ to DIR  
 REL Relative  
 IX Indexed, No Offset  
 IX1 Indexed, 8-Bit Offset  
 IX2 Indexed, 16-Bit Offset  
 IMM to DIR  
 DIR to IX+  
 SP1 Stack Pointer, 8-Bit Offset  
 SP2 Stack Pointer, 16-Bit Offset  
 IX+ Indexed, No Offset with Post Increment  
 IX1+ Indexed, 1-Byte Offset with Post Increment

Opcode in Hexadecimal: F0 SUB 3  
 Number of Bytes: 1 IX  
 HCS08 Cycles Instruction Mnemonic Addressing Mode

**Table 7-3. Opcode Map (Sheet 2 of 2)**

Bit-Manipulation	Branch	Read-Modify-Write			Control			Register/Memory					
				9E60 NEG 3 SP1					9ED0 SUB 4 SP2	9EE0 SUB 3 SP1			
				9E61 CBEQ 4 SP1					9ED1 CMP 4 SP2	9EE1 CMP 3 SP1			
									9ED2 SBC 4 SP2	9EE2 SBC 3 SP1			
				9E63 COM 3 SP1					9ED3 CPX 4 SP2	9EE3 CPX 3 SP1	9EF3 CPHX 3 SP1		
				9E64 LSR 3 SP1					9ED4 AND 4 SP2	9EE4 AND 3 SP1			
									9ED5 BIT 4 SP2	9EE5 BIT 3 SP1			
				9E66 ROR 3 SP1					9ED6 LDA 4 SP2	9EE6 LDA 3 SP1			
				9E67 ASR 3 SP1					9ED7 STA 4 SP2	9EE7 STA 3 SP1			
				9E68 LSL 3 SP1					9ED8 EOR 4 SP2	9EE8 EOR 3 SP1			
				9E69 ROL 3 SP1					9ED9 ADC 4 SP2	9EE9 ADC 3 SP1			
				9E6A DEC 3 SP1					9EDA ORA 4 SP2	9EEA ORA 3 SP1			
				9E6B DBNZ 4 SP1					9EDB ADD 4 SP2	9EEB ADD 3 SP1			
				9E6C INC 3 SP1									
				9E6D TST 3 SP1									
								9EAE LDHX 2 IX	9EBE LDHX 4 IX2	9ECE LDHX 3 IX1	9EDE LDX 4 SP2	9EEE LDX 3 SP1	9EFE LDHX 3 SP1
				9E6F CLR 3 SP1					9EDF STX 4 SP2	9EEF STX 3 SP1	9EFF STHX 3 SP1		

INH Inherent      REL Relative      SP1 Stack Pointer, 8-Bit Offset  
 IMM Immediate    IX Indexed, No Offset    SP2 Stack Pointer, 16-Bit Offset  
 DIR Direct        IX1 Indexed, 8-Bit Offset    IX+ Indexed, No Offset with  
 EXT Extended     IX2 Indexed, 16-Bit Offset    Post Increment  
 DD DIR to DIR    IMD IMM to DIR            IX1+ Indexed, 1-Byte Offset with  
 IX+D IX+ to DIR    DIX+ DIR to IX+            Post Increment

Note: All Sheet 2 Opcodes are Preceded by the Page 2 Prebyte (9E)

Prebyte (9E) and Opcode in  
 Hexadecimal    9E60 6    HCS08 Cycles  
                               NEG    3    Instruction Mnemonic  
 Number of Bytes    3    SP1    Addressing Mode



## Chapter 8

# Internal Clock Source (S08ICSV3)

### 8.1 Introduction

The internal clock source (ICS) module provides clock source choices for the MCU. The module contains a frequency-locked loop (FLL) as a clock source that is controllable by an internal reference clock. The module can provide this FLL clock or the internal reference clock as a source for the MCU system clock, ICSOUT.

Whichever clock source is chosen, ICSOUT is passed through a bus clock divider (BDIV), which allows a lower final output clock frequency to be derived. ICSOUT is twice the bus frequency.

The ICS on the MC9S08FL16 is configured to support only the low range DCO output. Therefore, the DRS and DRST bits in ICSSC have no affect. The FLL will multiply the reference clock only by 512 or 608 depending on the state of the DMX32 bit.

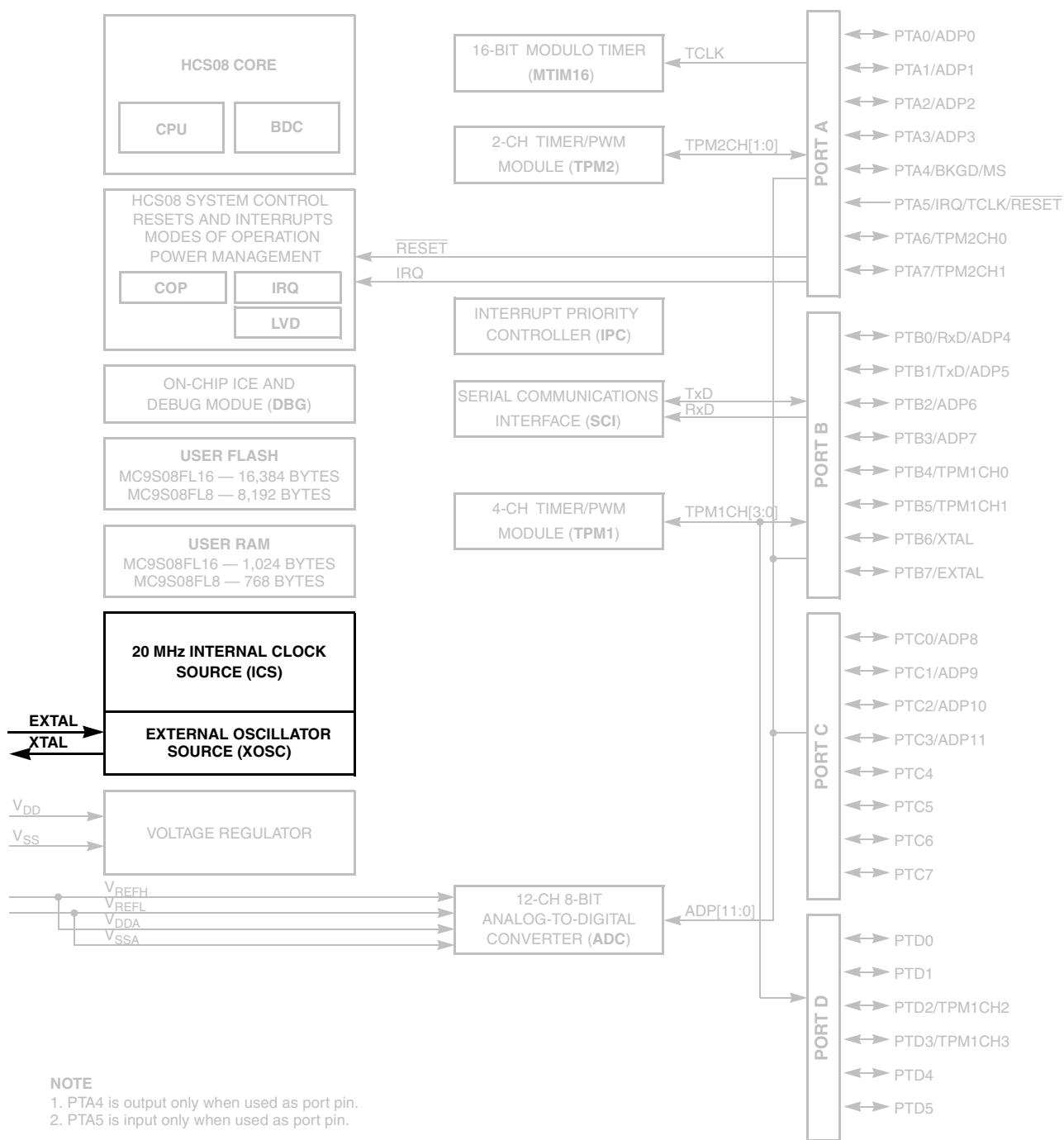

Figure 8-1. MC9S08FL16 Series Block Diagram Highlighting ICS Module and Pins

## 8.1.1 Features

Key features of the ICS module are:

- Frequency-locked loop (FLL) is trimmable for accuracy
- Internal or external reference clocks can be used to control the FLL
- Reference divider is provided for external clock
- Internal reference clock has 9 trim bits available
- Internal or external reference clocks can be selected as the clock source for the MCU
- Whichever clock is selected as the source can be divided down
  - 2-bit select for clock divider is provided
    - Allowable dividers are: 1, 2, 4, 8
- Control signals for a low power oscillator clock generator (OSCOUT) as the ICS external reference clock are provided
  - HGO, RANGE, EREFS, ERCLKEN, EREFSTEN
- FLL Engaged Internal mode is automatically selected out of reset
- BDC clock is provided as a constant divide by 2 of the low range DCO output
- Three selectable digitally-controlled oscillators (DCO) optimized for different frequency ranges.
- Option to maximize output frequency for a 32768 Hz external reference clock source.

## 8.1.2 Block Diagram

Figure 8-2 is the ICS block diagram.

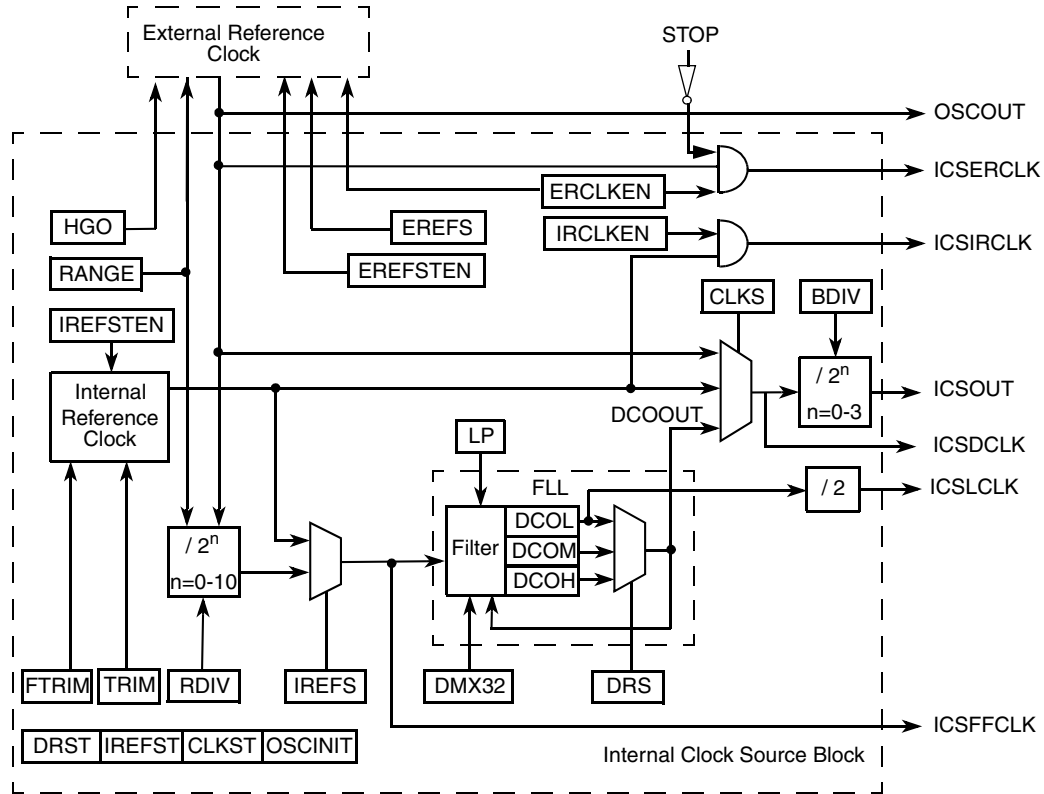

Figure 8-2. Internal Clock Source (ICS) Block Diagram

### 8.1.3 Modes of Operation

There are seven modes of operation for the ICS: FEI, FEE, FBI, FBILP, FBE, FBELP, and stop.

#### 8.1.3.1 FLL Engaged Internal (FEI)

In FLL engaged internal mode, which is the default mode, the ICS supplies a clock derived from the FLL which is controlled by the internal reference clock. The BDC clock is supplied from the FLL.

#### 8.1.3.2 FLL Engaged External (FEE)

In FLL engaged external mode, the ICS supplies a clock derived from the FLL which is controlled by an external reference clock source. The BDC clock is supplied from the FLL.

#### 8.1.3.3 FLL Bypassed Internal (FBI)

In FLL bypassed internal mode, the FLL is enabled and controlled by the internal reference clock, but is bypassed. The ICS supplies a clock derived from the internal reference clock. The BDC clock is supplied from the FLL.

### 8.1.3.4 FLL Bypassed Internal Low Power (FBILP)

In FLL bypassed internal low power mode, the FLL is disabled and bypassed, and the ICS supplies a clock derived from the internal reference clock. The BDC clock is not available.

### 8.1.3.5 FLL Bypassed External (FBE)

In FLL bypassed external mode, the FLL is enabled and controlled by an external reference clock, but is bypassed. The ICS supplies a clock derived from the external reference clock source. The BDC clock is supplied from the FLL.

### 8.1.3.6 FLL Bypassed External Low Power (FBELP)

In FLL bypassed external low power mode, the FLL is disabled and bypassed, and the ICS supplies a clock derived from the external reference clock. The BDC clock is not available.

### 8.1.3.7 Stop (STOP)

In stop mode, the FLL is disabled and the internal or the ICS external reference clocks source (OSCOUT) can be selected to be enabled or disabled. The BDC clock is not available and the ICS does not provide an MCU clock source.

#### NOTE

The DCO frequency changes from the pre-stop value to its reset value and the FLL will need to re-acquire the lock before the frequency is stable. Timing sensitive operations should wait for the FLL acquisition time before executing.

## 8.2 External Signal Description

There are no ICS signals that connect off chip.

## 8.3 Register Definition

Figure 8-1 is a summary of ICS registers.

Table 8-1. ICS Register Summary

Name		7	6	5	4	3	2	1	0
ICSC1	R	CLKS		RDIV			IREFS	IRCLKEN	IREFSTEN
	W								
ICSC2	R	BDIV		RANGE	HGO	LP	EREFS	ERCLKEN	EREFSTEN
	W								
ICSTRM	R	TRIM							
	W								

**Table 8-1. ICS Register Summary (continued)**

Name		7	6	5	4	3	2	1	0
ICSSC	R	DRST		DMX32	IREFST	CLKST		OSCINIT	FTRIM
	W	DRS							

### 8.3.1 ICS Control Register 1 (ICSC1)

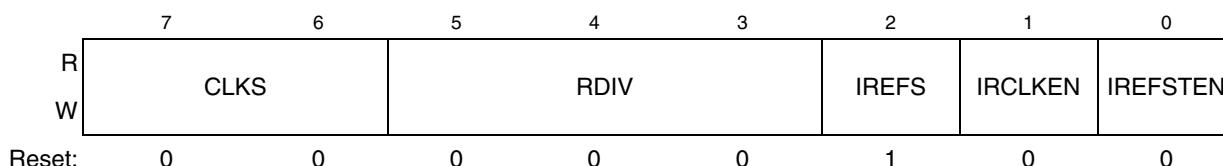

**Figure 8-3. ICS Control Register 1 (ICSC1)**

**Table 8-2. ICS Control Register 1 Field Descriptions**

Field	Description
7:6 CLKS	<b>Clock Source Select</b> — Selects the clock source that controls the bus frequency. The actual bus frequency depends on the value of the BDIV bits. 00 Output of FLL is selected. 01 Internal reference clock is selected. 10 External reference clock is selected. 11 Reserved, defaults to 00.
5:3 RDIV	<b>Reference Divider</b> — Selects the amount to divide down the external reference clock. Resulting frequency must be in the range 31.25 kHz to 39.0625 kHz. See <a href="#">Table 8-3</a> for the divide-by factors.
2 IREFS	<b>Internal Reference Select</b> — The IREFS bit selects the reference clock source for the FLL. 1 Internal reference clock selected. 0 External reference clock selected.
1 IRCLKEN	<b>Internal Reference Clock Enable</b> — The IRCLKEN bit enables the internal reference clock for use as ICSIRCLK. 1 ICSIRCLK active. 0 ICSIRCLK inactive.
0 IREFSTEN	<b>Internal Reference Stop Enable</b> — The IREFSTEN bit controls whether or not the internal reference clock remains enabled when the ICS enters stop mode. 1 Internal reference clock stays enabled in stop if IRCLKEN is set before entering stop. 0 Internal reference clock is disabled in stop.

**Table 8-3. Reference Divide Factor**

RDIV	RANGE=0	RANGE=1
0	1 <sup>1</sup>	32
1	2	64
2	4	128
3	8	256

**Table 8-3. Reference Divide Factor**

RDIV	RANGE=0	RANGE=1
4	16	512
5	32	1024
6	64	Reserved
7	128	Reserved

<sup>1</sup> Reset default

### 8.3.2 ICS Control Register 2 (ICSC2)

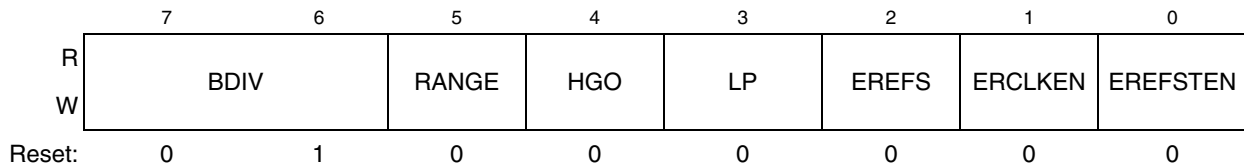
**Figure 8-4. ICS Control Register 2 (ICSC2)**
**Table 8-4. ICS Control Register 2 Field Descriptions**

Field	Description
7:6 BDIV	<b>Bus Frequency Divider</b> — Selects the amount to divide down the clock source selected by the CLKS bits. This controls the bus frequency. 00 Encoding 0 — Divides selected clock by 1. 01 Encoding 1 — Divides selected clock by 2 (reset default). 10 Encoding 2 — Divides selected clock by 4. 11 Encoding 3 — Divides selected clock by 8.
5 RANGE	<b>Frequency Range Select</b> — Selects the frequency range for the external oscillator. 1 High frequency range selected for the external oscillator. 0 Low frequency range selected for the external oscillator.
4 HGO	<b>High Gain Oscillator Select</b> — The HGO bit controls the external oscillator mode of operation. 1 Configure external oscillator for high gain operation. 0 Configure external oscillator for low power operation.
3 LP	<b>Low Power Select</b> — The LP bit controls whether the FLL is disabled in FLL bypassed modes. 1 FLL is disabled in bypass modes unless BDM is active. 0 FLL is not disabled in bypass mode.
2 EREFs	<b>External Reference Select</b> — The EREFs bit selects the source for the external reference clock. 1 Oscillator requested. 0 External Clock Source requested.
1 ERCLKEN	<b>External Reference Enable</b> — The ERCLKEN bit enables the external reference clock for use as ICsERCLK. 1 ICsERCLK active. 0 ICsERCLK inactive.
0 EREFSTEN	<b>External Reference Stop Enable</b> — The EREFSTEN bit controls whether or not the external reference clock source (OSCOUT) remains enabled when the ICS enters stop mode. 1 External reference clock source stays enabled in stop if ERCLKEN is set before entering stop. 0 External reference clock source is disabled in stop.

### 8.3.3 ICS Trim Register (ICSTRM)

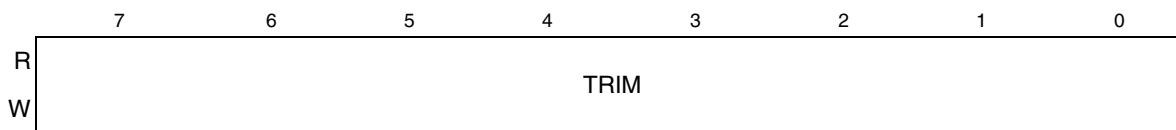

Reset: Note: TRIM is loaded during reset from a factory programmed location when not in BDM mode. If in a BDM mode, a default value of 0x80 is loaded.

Figure 8-5. ICS Trim Register (ICSTRM)

Table 8-5. ICS Trim Register Field Descriptions

Field	Description
7:0 TRIM	<p><b>ICS Trim Setting</b> — The TRIM bits control the internal reference clock frequency by controlling the internal reference clock period. The bits' effect are binary weighted (in other words, bit 1 adjusts twice as much as bit 0). Increasing the binary value in TRIM will increase the period, and decreasing the value will decrease the period.</p> <p>An additional fine trim bit is available in ICSSC as the FTRIM bit.</p>

### 8.3.4 ICS Status and Control (ICSSC)

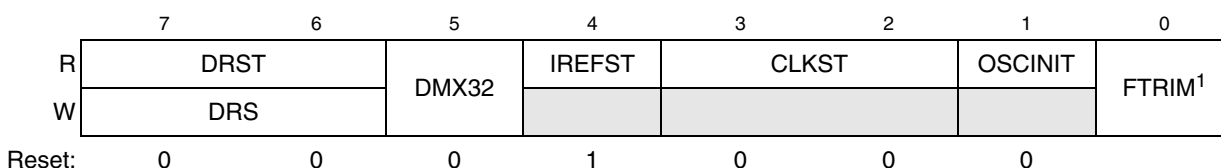

Figure 8-6. ICS Status and Control Register (ICSSC)

<sup>1</sup> FTRIM is loaded during reset from a factory programmed location when not in any BDM mode. If in a BDM mode, FTRIM gets loaded with a value of 1'b0.

Table 8-6. ICS Status and Control Register Field Descriptions

Field	Description
7-6 DRST DRS	<p><b>DCO Range Status</b> — The DRST read field indicates the current frequency range for the FLL output, DCOOUT. See <a href="#">Table 8-7</a>. The DRST field does not update immediately after a write to the DRS field due to internal synchronization between clock domains. Writing the DRS bits to 2'b11 is ignored and the DRST bits remain with the current setting.</p> <p><b>DCO Range Select</b> — The DRS field selects the frequency range for the FLL output, DCOOUT. Writes to the DRS field while the LP bit is set are ignored.</p> <p>00 Low range. 01 Mid range. 10 High range. 11 Reserved.</p>
5 DMX32	<p><b>DCO Maximum frequency with 32.768 kHz reference</b> — The DMX32 bit controls whether or not the DCO frequency range is narrowed to its maximum frequency with a 32.768 kHz reference. See <a href="#">Table 8-7</a>.</p> <p>0 DCO has default range of 25%. 1 DCO is fined tuned for maximum frequency with 32.768 kHz reference.</p>



**Table 8-6. ICS Status and Control Register Field Descriptions (continued)**

Field	Description
4 IREFST	<b>Internal Reference Status</b> — The IREFST bit indicates the current source for the reference clock. The IREFST bit does not update immediately after a write to the IREFS bit due to internal synchronization between clock domains. 0 Source of reference clock is external clock. 1 Source of reference clock is internal clock.
3-2 CLKST	<b>Clock Mode Status</b> — The CLKST bits indicate the current clock mode. The CLKST bits don't update immediately after a write to the CLKS bits due to internal synchronization between clock domains. 00 Output of FLL is selected. 01 FLL Bypassed, Internal reference clock is selected. 10 FLL Bypassed, External reference clock is selected. 11 Reserved.
1 OSCINIT	<b>OSC Initialization</b> — If the external reference clock is selected by ERCLKEN or by the ICS being in FEE, FBE, or FBELP mode, and if EREFS is set, then this bit is set after the initialization cycles of the external oscillator clock have completed. This bit is only cleared when either ERCLKEN or EREFS are cleared.
0 FTRIM	<b>ICS Fine Trim</b> — The FTRIM bit controls the smallest adjustment of the internal reference clock frequency. Setting FTRIM will increase the period and clearing FTRIM will decrease the period by the smallest amount possible.

**Table 8-7. DCO frequency range<sup>1</sup>**

DRS	DMX32	Reference range	FLL factor	DCO range
00	0	31.25 - 39.0625 kHz	512	16 - 20 MHz
	1	32.768 kHz	608	19.92 MHz
01	0	31.25 - 39.0625 kHz	1024	32 - 40 MHz
	1	32.768 kHz	1216	39.85 MHz
10	0	31.25 - 39.0625 kHz	1536	48 - 60 MHz
	1	32.768 kHz	1824	59.77 MHz
11	Reserved			

<sup>1</sup> The resulting bus clock frequency should not exceed the maximum specified bus clock frequency of the device.

## 8.4 Functional Description

### 8.4.1 Operational Modes

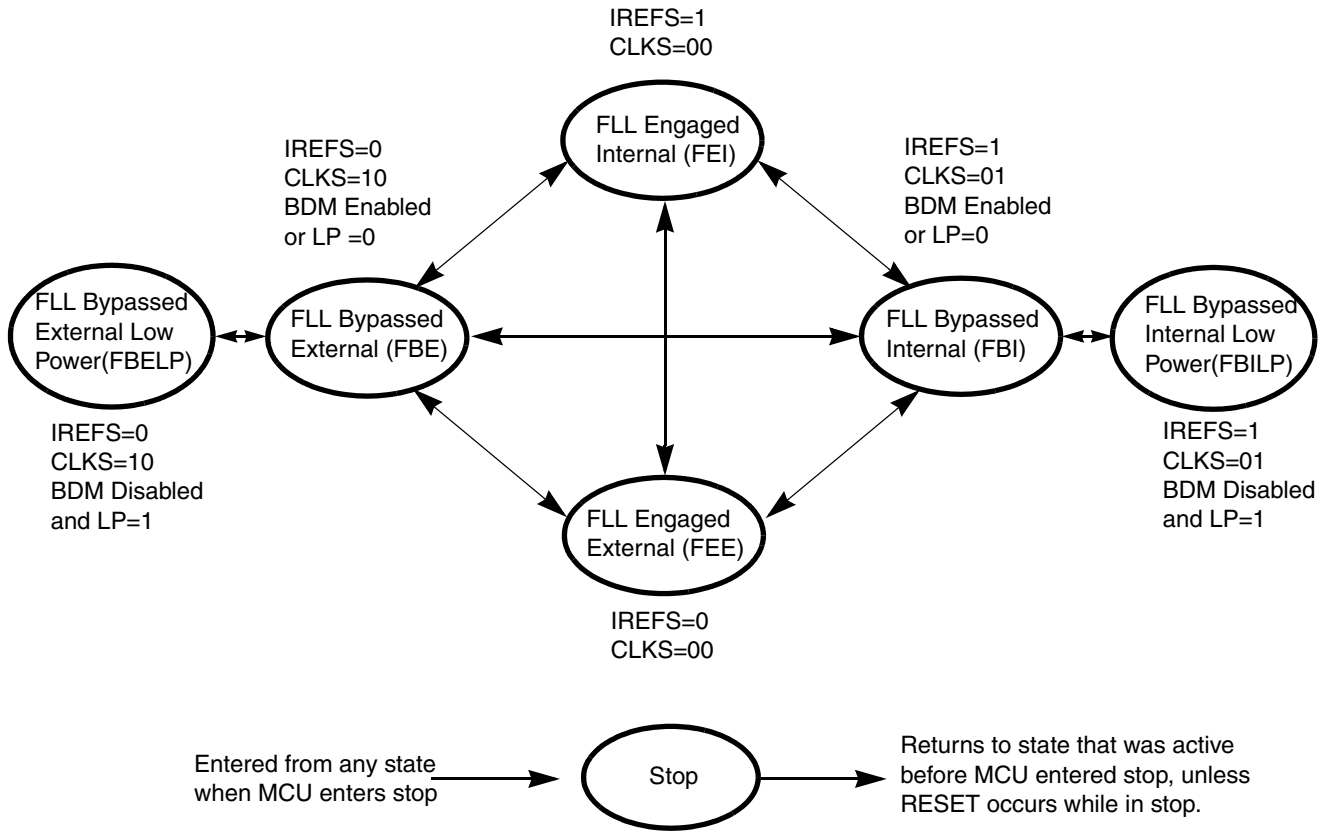

Figure 8-7. Clock Switching Modes

The seven states of the ICS are shown as a state diagram and are described below. The arrows indicate the allowed movements between the states.

#### 8.4.1.1 FLL Engaged Internal (FEI)

FLL engaged internal (FEI) is the default mode of operation and is entered when all the following conditions occur:

- CLKS bits are written to 00.
- IREFS bit is written to 1.

In FLL engaged internal mode, the ICSOUT clock is derived from the FLL clock, which is controlled by the internal reference clock. The FLL loop locks the frequency to the FLL factor times the internal reference frequency. The ICSLCLK is available for BDC communications, and the internal reference clock is enabled.

### 8.4.1.2 FLL Engaged External (FEE)

The FLL engaged external (FEE) mode is entered when all the following conditions occur:

- CLKS bits are written to 00.
- IREFS bit is written to 0.
- RDIV bits are written to divide external reference clock to be within the range of 31.25 kHz to 39.0625 kHz.

In FLL engaged external mode, the ICSOUT clock is derived from the FLL clock which is controlled by the external reference clock source. The FLL loop locks the frequency to the FLL factor times the external reference frequency, as selected by the RDIV bits. The ICSLCLK is available for BDC communications, and the external reference clock is enabled.

### 8.4.1.3 FLL Bypassed Internal (FBI)

The FLL bypassed internal (FBI) mode is entered when all the following conditions occur:

- CLKS bits are written to 01.
- IREFS bit is written to 1.
- BDM mode is active or LP bit is written to 0.

In FLL bypassed internal mode, the ICSOUT clock is derived from the internal reference clock. The FLL clock is controlled by the internal reference clock, and the FLL loop locks the FLL frequency to the FLL factor times the internal reference frequency. The ICSLCLK will be available for BDC communications, and the internal reference clock is enabled.

### 8.4.1.4 FLL Bypassed Internal Low Power (FBILP)

The FLL bypassed internal low power (FBILP) mode is entered when all the following conditions occur:

- CLKS bits are written to 01.
- IREFS bit is written to 1.
- BDM mode is not active and LP bit is written to 1.

In FLL bypassed internal low power mode, the ICSOUT clock is derived from the internal reference clock and the FLL is disabled. The ICSLCLK will be not be available for BDC communications, and the internal reference clock is enabled.

### 8.4.1.5 FLL Bypassed External (FBE)

The FLL bypassed external (FBE) mode is entered when all the following conditions occur:

- CLKS bits are written to 10.
- IREFS bit is written to 0.
- RDIV bits are written to divide external reference clock to be within the range of 31.25 kHz to 39.0625 kHz.
- BDM mode is active or LP bit is written to 0.

In FLL bypassed external mode, the ICSOUT clock is derived from the external reference clock source. The FLL clock is controlled by the external reference clock, and the FLL loop locks the FLL frequency to the FLL factor times the external reference frequency, as selected by the RDIV bits, so that the ICSLCLK will be available for BDC communications, and the external reference clock is enabled.

### 8.4.1.6 FLL Bypassed External Low Power (FBELP)

The FLL bypassed external low power (FBELP) mode is entered when all the following conditions occur:

- CLKS bits are written to 10.
- IREFS bit is written to 0.
- BDM mode is not active and LP bit is written to 1.

In FLL bypassed external low power mode, the ICSOUT clock is derived from the external reference clock source and the FLL is disabled. The ICSLCLK will be not be available for BDC communications. The external reference clock source is enabled.

### 8.4.1.7 Stop

Stop mode is entered whenever the MCU enters a STOP state. In this mode, all ICS clock signals are static except in the following cases:

ICSIRCLK will be active in stop mode when all the following conditions occur:

- IRCLKEN bit is written to 1.
- IREFSTEN bit is written to 1.

OSCOUT will be active in stop mode when all the following conditions occur:

- ERCLKEN bit is written to 1.
- EREFSTEN bit is written to 1.

## 8.4.2 Mode Switching

The IREF bit can be changed at anytime, but the actual switch to the newly selected clock is shown by the IREFST bit. When switching between FLL engaged internal (FEI) and FLL engaged external (FEE) modes, the FLL begins locking again after the switch is completed.

The CLKS bits can also be changed at anytime, but the actual switch to the newly selected clock is shown by the CLKST bits. If the newly selected clock is not available, the previous clock remains selected.

The DRS bits can be changed at anytime except when LP bit is 1. If the DRS bits are changed while in FLL engaged internal (FEI) or FLL engaged external (FEE), the bus clock remains at the previous DCO range until the new DCO starts. When the new DCO starts the bus clock switches to it. After switching to the new DCO the FLL remains unlocked for several reference cycles. Once the selected DCO startup time is over, the FLL is locked. The completion of the switch is shown by the DRST bits.

### 8.4.3 Bus Frequency Divider

The BDIV bits can be changed at anytime and the actual switch to the new frequency occurs immediately.

### 8.4.4 Low Power Bit Usage

The low power bit (LP) is provided to allow the FLL to be disabled and thus conserve power when it is not being used. The DRS bits can not be written while LP bit is 1.

However, in some applications it may be desirable to allow the FLL to be enabled and to lock for maximum accuracy before switching to an FLL engaged mode. To do this, write the LP bit to 0.

### 8.4.5 DCO Maximum Frequency with 32.768 kHz Oscillator

The FLL has an option to change the clock multiplier for the selected DCO range such that it results in the maximum bus frequency with a common 32.768 kHz crystal reference clock.

### 8.4.6 Internal Reference Clock

When IRCLKEN is set the internal reference clock signal is presented as ICSIRCLK, which can be used as an additional clock source. To re-target the ICSIRCLK frequency, write a new value to the TRIM bits in the ICSTRM register to trim the period of the internal reference clock:

- Writing a larger value slows down the ICSIRCLK frequency.
- Writing a smaller value to the ICSTRM register speeds up the ICSIRCLK frequency.

The TRIM bits effect the ICSOUT frequency if the ICS is in FLL engaged internal (FEI), FLL bypassed internal (FBI), or FLL bypassed internal low power (FBILP) mode.

Until ICSIRCLK is trimmed, programming low reference divider (RDIV) factors may result in ICSOUT frequencies that exceed the maximum chip-level frequency and violate the chip-level clock timing specifications (see the [Device Overview](#) chapter).

If IREFSTEN is set and the IRCLKEN bit is written to 1, the internal reference clock keeps running during stop mode in order to provide a fast recovery upon exiting stop.

All MCU devices are factory programmed with a trim value in a reserved memory location. This value is uploaded to the ICSTRM register and ICS FTRIM register during any reset initialization. For finer precision, trim the internal oscillator in the application and set the FTRIM bit accordingly.

### 8.4.7 External Reference Clock

The ICS module supports an external reference clock with frequencies between 31.25 kHz to 40 MHz in all modes. When the ERCLKEN is set, the external reference clock signal is presented as ICSECLK, which can be used as an additional clock source in run mode. When IREFS = 1, the external reference clock is not used by the FLL and will only be used as ICSECLK. In these modes, the frequency can be equal to the maximum frequency the chip-level timing specifications support (see the [Device Overview](#) chapter).

If EREFSTEN is set and the ERCLKEN bit is written to 1, the external reference clock source (OSCOUT) keeps running during stop mode in order to provide a fast recovery upon exiting stop.

### 8.4.8 Fixed Frequency Clock

The ICS presents the divided FLL reference clock as ICSFFCLK for use as an additional clock source. ICSFFCLK frequency must be no more than 1/4 of the ICSOUT frequency to be valid.

### 8.4.9 Local Clock

The ICS presents the low range DCO output clock divided by two as ICSLCLK for use as a clock source for BDC communications. ICSLCLK is not available in FLL bypassed internal low power (FBILP) and FLL bypassed external low power (FBELP) modes.

## Chapter 9

# 16-Bit Timer/PWM (S08TPMV3)

### 9.1 Introduction

MC9S08FL16 series contain two multi-channel TPM modules. TPM1 contains four 16-bit channels and TPM2 contains two 16-bit channels. Each channel can operate as input capture, output compare, or buffered edge- or center-aligned PWM functions.

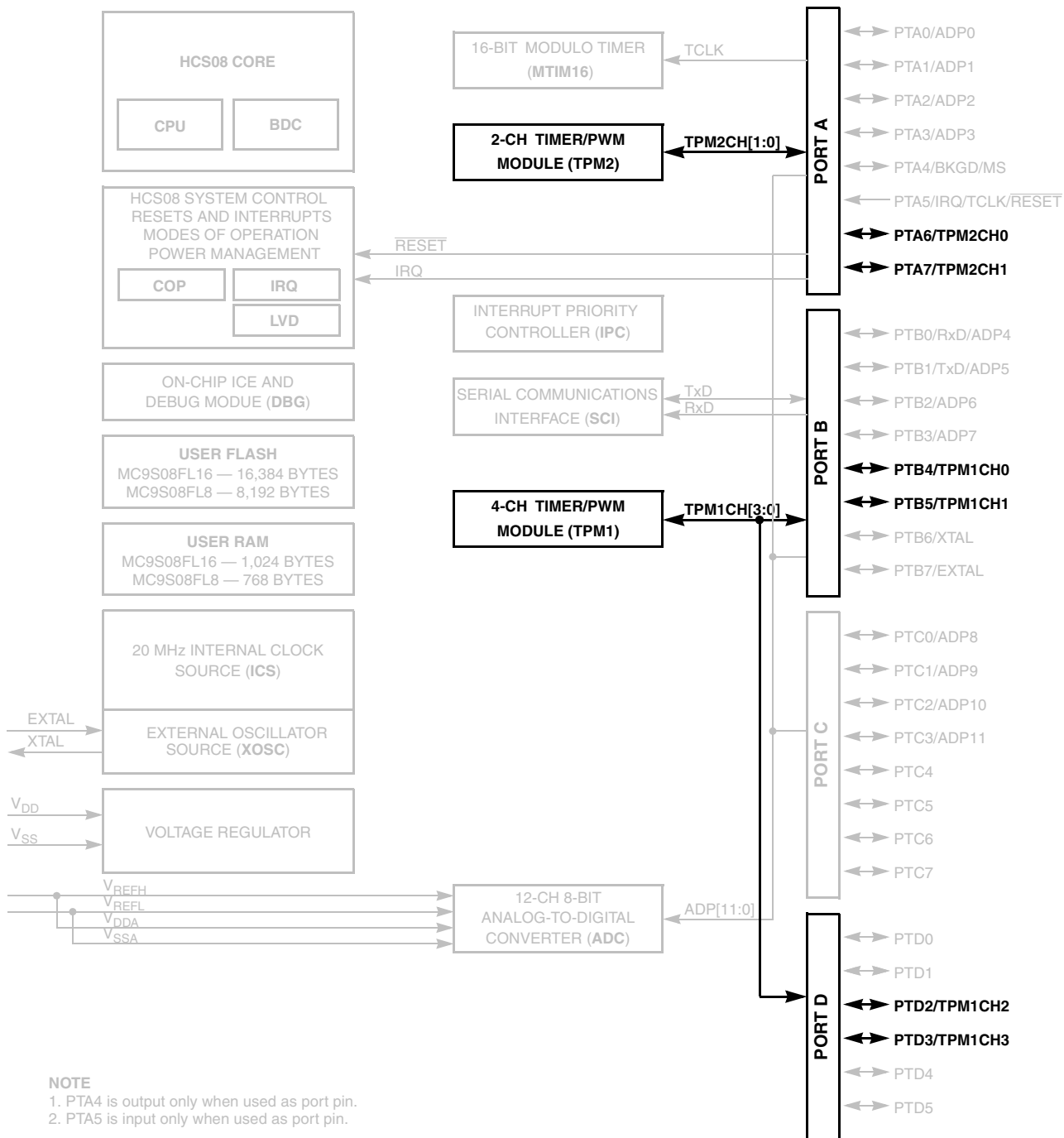

Figure 9-1. MC9S08FL16 Series Block Diagram Highlighting TPM Modules and Pins

### 9.1.1 TPMV3 Differences from Previous Versions

The TPMV3 is the latest version of the Timer/PWM module that addresses errata found in previous versions. The following section outlines the differences between TPMV3 and TPMV2 modules, and any considerations that should be taken when porting code.



Table 9-1. TPMV2 and TPMV3 Porting Considerations

Action	TPMV3	TPMV2
<b>Write to TPMxCnTH:L registers<sup>1</sup></b>		
Any write to TPMxCNTH or TPMxCNTL registers	Clears the TPM counter (TPMxCNTH:L) and the prescaler counter.	Clears the TPM counter (TPMxCNTH:L) only.
<b>Read of TPMxCNTH:L registers<sup>1</sup></b>		
In BDM mode, any read of TPMxCNTH:L registers	Returns the value of the TPM counter that is frozen.	If only one byte of the TPMxCNTH:L registers was read before the BDM mode became active, returns the latched value of TPMxCNTH:L from the read buffer (instead of the frozen TPM counter value).
In BDM mode, a write to TPMxSC, TPMxCNTH or TPMxCNTL	Clears this read coherency mechanism.	Does not clear this read coherency mechanism.
<b>Read of TPMxCnVH:L registers<sup>2</sup></b>		
In BDM mode, any read of TPMxCnVH:L registers	Returns the value of the TPMxCnVH:L register.	If only one byte of the TPMxCnVH:L registers was read before the BDM mode became active, returns the latched value of TPMxCNTH:L from the read buffer (instead of the value in the TPMxCnVH:L registers).
In BDM mode, a write to TPMxCnSC	Clears this read coherency mechanism.	Does not clear this read coherency mechanism.
<b>Write to TPMxCnVH:L registers</b>		
In Input Capture mode, writes to TPMxCnVH:L registers <sup>3</sup>	Not allowed.	Allowed.
In Output Compare mode, when (CLKSB:CLKSA not = 0:0), writes to TPMxCnVH:L registers <sup>3</sup>	Update the TPMxCnVH:L registers with the value of their write buffer at the next change of the TPM counter (end of the prescaler counting) after the second byte is written.	Always update these registers when their second byte is written.
In Edge-Aligned PWM mode when (CLKSB:CLKSA not = 00), writes to TPMxCnVH:L registers	Update the TPMxCnVH:L registers with the value of their write buffer after both bytes were written and when the TPM counter changes from (TPMxMODH:L - 1) to (TPMxMODH:L). <b>Note:</b> If the TPM counter is a free-running counter, then this update is made when the TPM counter changes from 0xFFFE to 0xFFFF.	Update after both bytes are written and when the TPM counter changes from TPMxMODH:L to 0x0000.

**Table 9-1. TPMV2 and TPMV3 Porting Considerations (continued)**

Action	TPMV3	TPMV2
In Center-Aligned PWM mode when (CLKSB:CLKSA not = 00), writes to TPMxCnVH:L registers <sup>4</sup>	Update the TPMxCnVH:L registers with the value of their write buffer after both bytes are written and when the TPM counter changes from (TPMxMODH:L - 1) to (TPMxMODH:L). <b>Note:</b> If the TPM counter is a free-running counter, then this update is made when the TPM counter changes from 0xFFFFE to 0xFFFF.	Update after both bytes are written and when the TPM counter changes from TPMxMODH:L to (TPMxMODH:L - 1).
<b>Center-Aligned PWM</b>		
When TPMxCnVH:L = TPMxMODH:L <sup>5</sup>	Produces 100% duty cycle.	Produces 0% duty cycle.
When TPMxCnVH:L = (TPMxMODH:L - 1) <sup>6</sup>	Produces a near 100% duty cycle.	Produces 0% duty cycle.
TPMxCnVH:L is changed from 0x0000 to a non-zero value <sup>7</sup>	Waits for the start of a new PWM period to begin using the new duty cycle setting.	Changes the channel output at the middle of the current PWM period (when the count reaches 0x0000).
TPMxCnVH:L is changed from a non-zero value to 0x0000 <sup>8</sup>	Finishes the current PWM period using the old duty cycle setting.	Finishes the current PWM period using the new duty cycle setting.
<b>Write to TPMxMODH:L registers in BDM mode</b>		
In BDM mode, a write to TPMxSC register	Clears the write coherency mechanism of TPMxMODH:L registers.	Does not clear the write coherency mechanism.

<sup>1</sup> For more information, refer to [Section 9.3.2, “TPM-Counter Registers \(TPMxCNTH:TPMxCNTL\)”](#) [SE110-TPM case 7]

<sup>2</sup> For more information, refer to [Section 9.3.5, “TPM Channel Value Registers \(TPMxCnVH:TPMxCnVL\)”](#)

<sup>3</sup> For more information, refer to [Section 9.4.2.1, “Input Capture Mode ”](#)

<sup>4</sup> For more information, refer to [Section 9.4.2.4, “Center-Aligned PWM Mode.”](#)

<sup>5</sup> For more information, refer to [Section 9.4.2.4, “Center-Aligned PWM Mode.”](#) [SE110-TPM case 1]

<sup>6</sup> For more information, refer to [Section 9.4.2.4, “Center-Aligned PWM Mode.”](#) [SE110-TPM case 2]

<sup>7</sup> For more information, refer to [Section 9.4.2.4, “Center-Aligned PWM Mode.”](#) [SE110-TPM case 3 and 5]

<sup>8</sup> For more information, refer to [Section 9.4.2.4, “Center-Aligned PWM Mode.”](#) [SE110-TPM case 4]

## 9.1.2 Migrating from TPMV1

In addition to [Section 9.1.1, “TPMV3 Differences from Previous Versions,”](#) keep in mind the following considerations when migrating from a device that uses TPMV1.

- You can write to the Channel Value register (TPMxCnV) when the timer is not in input capture mode for TPMV2, not TPMV3.

- In edge- or center- aligned modes, the Channel Value register (TPMxCnV) registers only update when the timer changes from TPMMOD-1 to TPMMOD, or in the case of a free running timer from 0xFFFFE to 0xFFFF.
- Also, when configuring the TPM modules, it is best to write to TPMxSC before TPMxCnV as a write to TPMxSC resets the coherency mechanism on the TPMxCnV registers.

**Table 9-2. Migrating to TPMV3 Considerations**

When...	Action / Best Practice
Writing to the Channel Value Register (TPMxCnV) register...	Timer must be in Input Capture mode.
Updating the Channel Value Register (TPMxCnV) register in edge-aligned or center-aligned modes...	Only occurs when the timer changes from TPMMOD-1 to TPMMOD (or in the case of a free running timer, from 0xFFFFE to 0xFFFF).
Resetting the coherency mechanism for the Channel Value Register (TPMxCnV) register...	Write to TPMxSC.
Configuring the TPM modules...	Write first to TPMxSC and then to TPMxCnV register.

### 9.1.3 Features

The TPM includes these distinctive features:

- One to eight channels:
  - Each channel is input capture, output compare, or edge-aligned PWM
  - Rising-edge, falling-edge, or any-edge input capture trigger
  - Set, clear, or toggle output compare action
  - Selectable polarity on PWM outputs
- Module is configured for buffered, center-aligned pulse-width-modulation (CPWM) on all channels
- Timer clock source selectable as bus clock, fixed frequency clock, or an external clock
  - Prescale taps for divide-by 1, 2, 4, 8, 16, 32, 64, or 128 used for any clock input selection
  - Fixed frequency clock is an additional clock input to allow the selection of an on chip clock source other than bus clock
  - Selecting external clock connects TPM clock to a chip level input pin therefore allowing to synchronize the TPM counter with an off chip clock source
- 16-bit free-running or modulus count with up/down selection
- One interrupt per channel and one interrupt for TPM counter overflow

### 9.1.4 Modes of Operation

In general, TPM channels are independently configured to operate in input capture, output compare, or edge-aligned PWM modes. A control bit allows the whole TPM (all channels) to switch to center-aligned PWM mode. When center-aligned PWM mode is selected, input capture, output compare, and edge-aligned PWM functions are not available on any channels of this TPM module.

When the MCU is in active BDM background or BDM foreground mode, the TPM temporarily suspends all counting until the MCU returns to normal user operating mode. During stop mode, all TPM input clocks are stopped, so the TPM is effectively disabled until clocks resume. During wait mode, the TPM continues to operate normally. If the TPM does not need to produce a real time reference or provide the interrupt sources needed to wake the MCU from wait mode, the power can then be saved by disabling TPM functions before entering wait mode.

- Input capture mode
 

When a selected edge event occurs on the associated MCU pin, the current value of the 16-bit timer counter is captured into the channel value register and an interrupt flag bit is set. Rising edges, falling edges, any edge, or no edge (disable channel) are selected as the active edge that triggers the input capture.
- Output compare mode
 

When the value in the timer counter register matches the channel value register, an interrupt flag bit is set, and a selected output action is forced on the associated MCU pin. The output compare action is selected to force the pin to zero, force the pin to one, toggle the pin, or ignore the pin (used for software timing functions).
- Edge-aligned PWM mode

The value of a 16-bit modulo register plus 1 sets the period of the PWM output signal. The channel value register sets the duty cycle of the PWM output signal. You can also choose the polarity of the PWM output signal. Interrupts are available at the end of the period and at the duty-cycle transition point. This type of PWM signal is called edge-aligned because the leading edges of all PWM signals are aligned with the beginning of the period that is same for all channels within a TPM.

- Center-aligned PWM mode

Twice the value of a 16-bit modulo register sets the period of the PWM output, and the channel-value register sets the half-duty-cycle duration. The timer counter counts up until it reaches the modulo value and then counts down until it reaches zero. As the count matches the channel value register while counting down, the PWM output becomes active. When the count matches the channel value register while counting up, the PWM output becomes inactive. This type of PWM signal is called center-aligned because the centers of the active duty cycle periods for all channels are aligned with a count value of zero. This type of PWM is required for types of motors used in small appliances.

This is a high-level description only. Detailed descriptions of operating modes are in later sections.

### 9.1.5 Block Diagram

The TPM uses one input/output (I/O) pin per channel, TPMxCHn (timer channel n) where n is the channel number (1–8). The TPM shares its I/O pins with general purpose I/O port pins (refer to I/O pin descriptions in full-chip specification for the specific chip implementation).

[Figure 9-2](#) shows the TPM structure. The central component of the TPM is the 16-bit counter that can operate as a free-running counter or a modulo up/down counter. The TPM counter (when operating in normal up-counting mode) provides the timing reference for the input capture, output compare, and edge-aligned PWM functions. The timer counter modulo registers, TPMxMODH:TPMxMODL, control the modulo value of the counter (the values 0x0000 or 0xFFFF effectively make the counter free running). Software can read the counter value at any time without affecting the counting sequence. Any write to either half of the TPMxCNT counter resets the counter, regardless of the data value written.

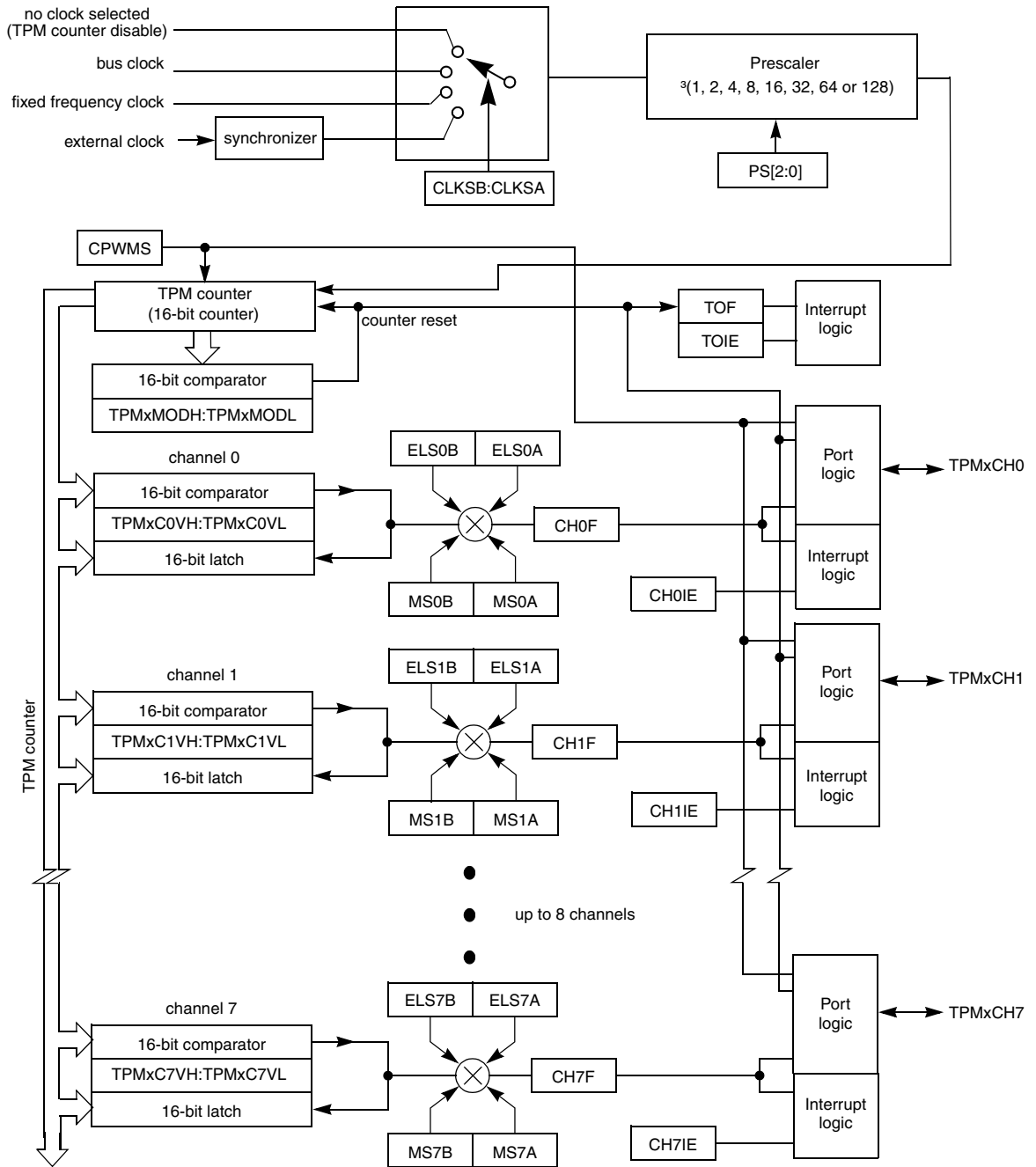

Figure 9-2. TPM Block Diagram

The TPM channels are programmable independently as input capture, output compare, or edge-aligned PWM channels. Alternately, the TPM can be configured to produce CPWM outputs on all channels. When the TPM is configured for CPWMs (the counter operates as an up/down counter) input capture, output compare, and EPWM functions are not practical.

## 9.2 Signal Description

Table 9-3 shows the user-accessible signals for the TPM. The number of channels are varied from one to eight. When an external clock is included, it can be shared with the same pin as any TPM channel; however, it could be connected to a separate input pin. Refer to the I/O pin descriptions in full-chip specification for the specific chip implementation.

**Table 9-3. Signal Properties**

Name	Function
EXTCLK <sup>1</sup>	External clock source that is selected to drive the TPM counter.
TPMxCHn <sup>2</sup>	I/O pin associated with TPM channel n.

<sup>1</sup> The external clock pin can be shared with any channel pin. However, depending upon full-chip implementation, this signal could be connected to a separate external pin.

<sup>2</sup> n = channel number (1–8)

### 9.2.1 Detailed Signal Descriptions

#### 9.2.1.1 EXTCLK — External Clock Source

The external clock signal can share the same pin as a channel pin, however the channel pin can not be used for channel I/O function when external clock is selected. If this pin is used as an external clock (CLKSB:CLKSA = 1:1), the channel can still be configured to output compare mode therefore allowing its use as a timer (ELSnB:ELSnA = 0:0).

For proper TPM operation, the external clock frequency must not exceed one-fourth of the bus clock frequency.

#### 9.2.1.2 TPMxCHn — TPM Channel n I/O Pins

The TPM channel does not control the I/O pin when ELSnB:ELSnA or CLKSb:CLKSA are cleared so it normally reverts to general purpose I/O control. When CPWMS is set and ELSnB:ELSnA are not cleared, all TPM channels are configured for center-aligned PWM and the TPMxCHn pins are all controlled by TPM. When CPWMS is cleared, the MSnB:MSnA control bits determine whether the channel is configured for input capture, output compare, or edge-aligned PWM.

When a channel is configured for input capture (CPWMS = 0, MSnB:MSnA = 0:0, and ELSnB:ELSnA ≠ 0:0), the TPMxCHn pin is forced to act as an edge-sensitive input to the TPM. ELSnB:ELSnA control bits determine what polarity edge or edges trigger input capture events. The channel input signal is synchronized on the bus clock. This implies the minimum pulse width—that can

be reliably detected—on an input capture pin is four bus clock periods (with ideal clock pulses as near as two bus clocks can be detected).

When a channel is configured for output compare (CPWMS = 0, MSnB:MSnA = 0:1, and ELSnB:ELSnA ≠ 0:0), the TPMxCHn pin is an output controlled by the TPM. The ELSnB:ELSnA bits determine whether the TPMxCHn pin is toggled, cleared, or set each time the 16-bit channel value register matches the TPM counter.

When the output compare toggle mode is initially selected, the previous value on the pin is driven out until the next output compare event, the pin is then toggled.

When a channel is configured for edge-aligned PWM (CPWMS = 0, MSnB = 1, and ELSnB:ELSnA ≠ 0:0), the TPMxCHn pin is an output controlled by the TPM, and ELSnB:ELSnA bits control the polarity of the PWM output signal. When ELSnB is set and ELSnA is cleared, the TPMxCHn pin is forced high at the start of each new period (TPMxCNT=0x0000), and it is forced low when the channel value register matches the TPM counter. When ELSnA is set, the TPMxCHn pin is forced low at the start of each new period (TPMxCNT=0x0000), and it is forced high when the channel value register matches the TPM counter.

TPMxMODH:TPMxMODL = 0x0008  
 TPMxCnVH:TPMxCnVL = 0x0005

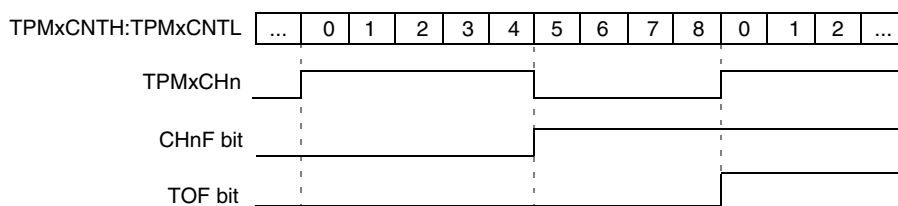

**Figure 9-3. High-true pulse of an edge-aligned PWM**

TPMxMODH:TPMxMODL = 0x0008  
 TPMxCnVH:TPMxCnVL = 0x0005

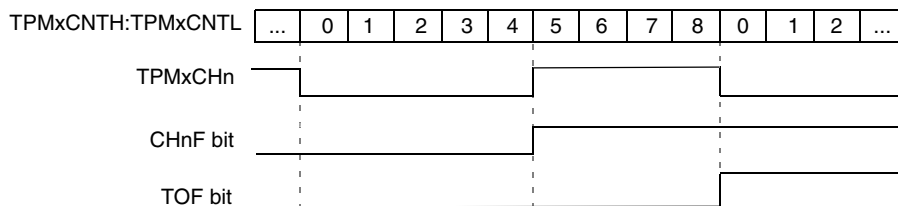

**Figure 9-4. Low-true pulse of an edge-aligned PWM**

When the TPM is configured for center-aligned PWM (CPWMS = 1 and ELSnB:ELSnA ≠ 0:0), the TPMxCHn pins are outputs controlled by the TPM, and ELSnB:ELSnA bits control the polarity of the PWM output signal. If ELSnB is set and ELSnA is cleared, the corresponding TPMxCHn pin is cleared when the TPM counter is counting up, and the channel value register matches the TPM counter; and it is



set when the TPM counter is counting down, and the channel value register matches the TPM counter. If ELSnA is set, the corresponding TPMxCHn pin is set when the TPM counter is counting up and the channel value register matches the TPM counter; and it is cleared when the TPM counter is counting down and the channel value register matches the TPM counter.

TPMxMODH:TPMxMODL = 0x0008  
 TPMxCnVH:TPMxCnVL = 0x0005

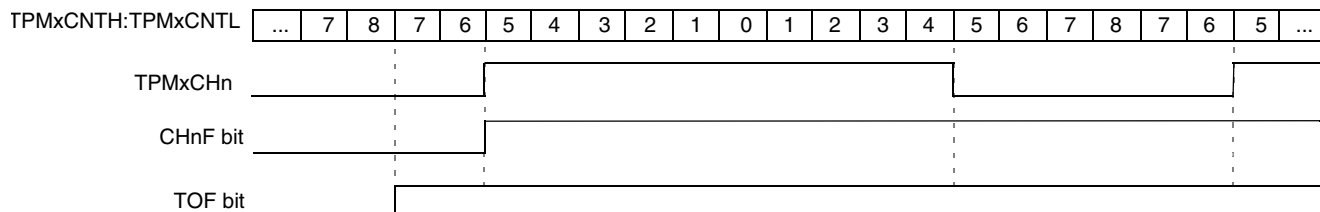

Figure 9-5. High-true pulse of a center-aligned PWM

TPMxMODH:TPMxMODL = 0x0008  
 TPMxCnVH:TPMxCnVL = 0x0005

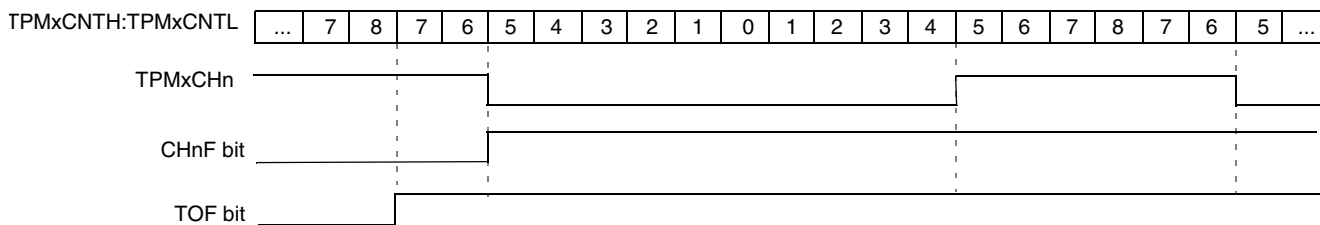

Figure 9-6. Low-true pulse of a center-aligned PWM

## 9.3 Register Definition

### 9.3.1 TPM Status and Control Register (TPMxSC)

TPMxSC contains the overflow status flag and control bits used to configure the interrupt enable, TPM configuration, clock source, and prescale factor. These controls relate to all channels within this timer module.

	7	6	5	4	3	2	1	0
R	TOF	TOIE	CPWMS	CLKSB	CLKSA	PS2	PS1	PS0
W	0							
Reset	0	0	0	0	0	0	0	0

Figure 9-7. TPM Status and Control Register (TPMxSC)

Table 9-4. TPMxSC Field Descriptions

Field	Description
7 TOF	Timer overflow flag. This read/write flag is set when the TPM counter resets to 0x0000 after reaching the modulo value programmed in the TPM counter modulo registers. Clear TOF by reading the TPM status and control register when TOF is set and then writing a logic 0 to TOF. If another TPM overflow occurs before the clearing sequence is completed, the sequence is reset so TOF remains set after the clear sequence was completed for the earlier TOF. This is done so a TOF interrupt request cannot be lost during the clearing sequence for a previous TOF. Reset clears TOF. Writing a logic 1 to TOF has no effect. 0 TPM counter has not reached modulo value or overflow. 1 TPM counter has overflowed.
6 TOIE	Timer overflow interrupt enable. This read/write bit enables TPM overflow interrupts. If TOIE is set, an interrupt is generated when TOF equals one. Reset clears TOIE. 0 TOF interrupts inhibited (use for software polling). 1 TOF interrupts enabled.
5 CPWMS	Center-aligned PWM select. This read/write bit selects CPWM operating mode. By default, the TPM operates in up-counting mode for input capture, output compare, and edge-aligned PWM functions. Setting CPWMS reconfigures the TPM to operate in up/down counting mode for CPWM functions. Reset clears CPWMS. 0 All channels operate as input capture, output compare, or edge-aligned PWM mode as selected by the MSnB:MSnA control bits in each channel's status and control register. 1 All channels operate in center-aligned PWM mode.
4-3 CLKS[B:A]	Clock source selection bits. As shown in Table 9-5, this 2-bit field is used to disable the TPM counter or select one of three clock sources to TPM counter and counter prescaler.
2-0 PS[2:0]	Prescale factor select. This 3-bit field selects one of eight division factors for the TPM clock as shown in Table 9-6. This prescaler is located after any clock synchronization or clock selection so it affects the clock selected to drive the TPM counter. The new prescale factor affects the selected clock on the next bus clock cycle after the new value is updated into the register bits.

Table 9-5. TPM Clock Selection

CLKSB:CLKSA	TPM Clock to Prescaler Input
00	No clock selected (TPM counter disable)

**Table 9-5. TPM Clock Selection**

CLKSB:CLKSA	TPM Clock to Prescaler Input
01	Bus clock
10	Fixed frequency clock
11	External clock

**Table 9-6. Prescale Factor Selection**

PS[2:0]	TPM Clock Divided-by
000	1
001	2
010	4
011	8
100	16
101	32
110	64
111	128

### 9.3.2 TPM-Counter Registers (TPMxCNTH:TPMxCNTL)

The two read-only TPM counter registers contain the high and low bytes of the value in the TPM counter. Reading either byte (TPMxCNTH or TPMxCNTL) latches the contents of both bytes into a buffer where they remain latched until the other half is read. This allows coherent 16-bit reads in big-endian or little-endian order that makes this more friendly to various compiler implementations. The coherency mechanism is automatically restarted by an MCU reset or any write to the timer status/control register (TPMxSC).

Reset clears the TPM counter registers. Writing any value to TPMxCNTH or TPMxCNTL also clears the TPM counter (TPMxCNTH:TPMxCNTL) and resets the coherency mechanism, regardless of the data involved in the write.

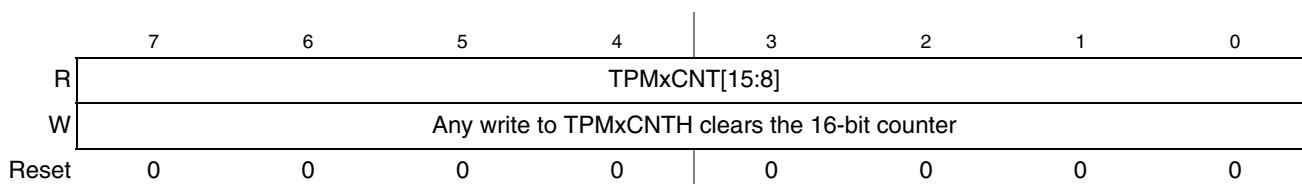
**Figure 9-8. TPM Counter Register High (TPMxCNTH)**

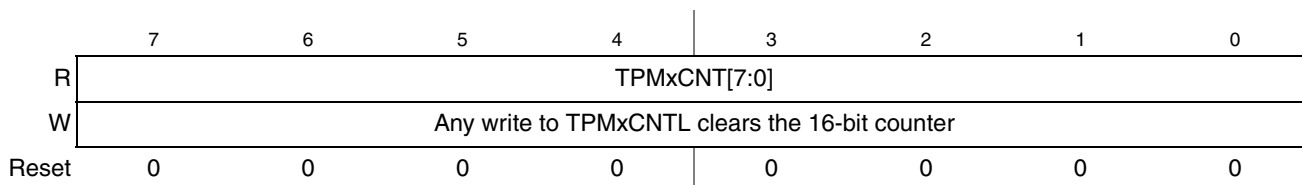

Figure 9-9. TPM Counter Register Low (TPMxCNTL)

When BDM is active, the timer counter is frozen (this is the value you read). The coherency mechanism is frozen so the buffer latches remain in the state they were in when the BDM became active, even if one or both counter halves are read while BDM is active. This assures that if you were in the middle of reading a 16-bit register when BDM became active, it reads the appropriate value from the other half of the 16-bit value after returning to normal execution.

In BDM mode, writing any value to TPMxSC, TPMxCNTH, or TPMxCNTL registers resets the read coherency mechanism of the TPMxCNTH:TPMxCNTL registers, regardless of the data involved in the write.

### 9.3.3 TPM Counter Modulo Registers (TPMxMODH:TPMxMODL)

The read/write TPM modulo registers contain the modulo value for the TPM counter. After the TPM counter reaches the modulo value, the TPM counter resumes counting from 0x0000 at the next clock, and the overflow flag (TOF) becomes set. Writing to TPMxMODH or TPMxMODL inhibits the TOF bit and overflow interrupts until the other byte is written. Reset sets the TPM counter modulo registers to 0x0000 that results in a free running timer counter (modulo disabled).

Writes to any of the registers TPMxMODH and TPMxMODL actually writes to buffer registers and the registers are updated with the value of their write buffer according to the value of CLKSb:CLKSA bits:

- If CLKSb and CLKSA are cleared, the registers are updated when the second byte is written
- If CLKSb and CLKSA are not cleared, the registers are updated after both bytes were written, and the TPM counter changes from (TPMxMODH:TPMxMODL – 1) to (TPMxMODH:TPMxMODL). If the TPM counter is a free-running counter, the update is made when the TPM counter changes from 0xFFFFE to 0xFFFF

The latching mechanism is manually reset by writing to the TPMxSC address (whether BDM is active or not).

When BDM is active, the coherency mechanism is frozen (unless reset by writing to TPMxSC register) so the buffer latches remain in the state they were in when the BDM became active, even if one or both halves of the modulo register are written while BDM is active. Any write to the modulo registers bypasses the buffer latches and directly writes to the modulo register while BDM is active.

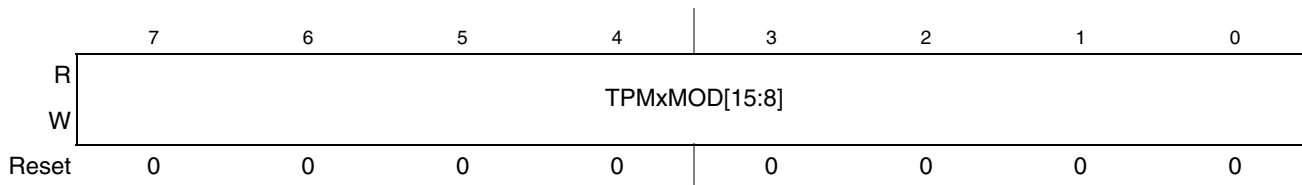
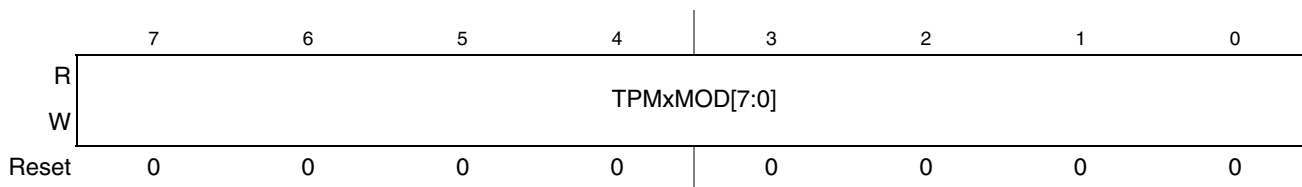

Figure 9-10. TPM Counter Modulo Register High (TPMxMODH)



Reset the TPM counter before writing to the TPM modulo registers to avoid confusion about when the first counter overflow occurs.

### 9.3.4 TPM Channel n Status and Control Register (TPMxCnSC)

TPMxCnSC contains the channel-interrupt-status flag and control bits that configure the interrupt enable, channel configuration, and pin function.

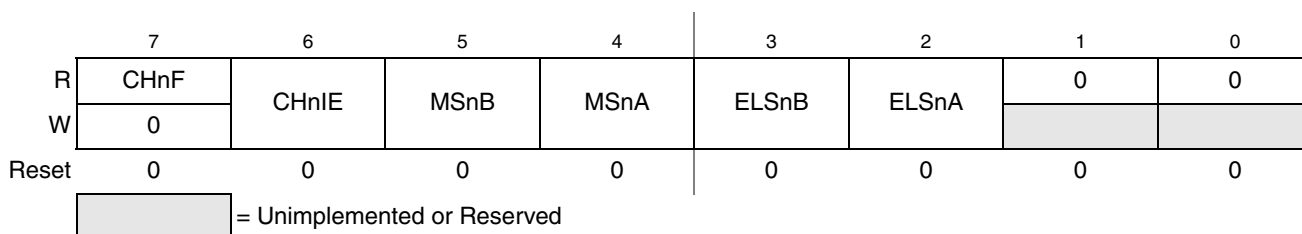

**Figure 9-12. TPM Channel n Status and Control Register (TPMxCnSC)**

**Table 9-7. TPMxCnSC Field Descriptions**

Field	Description
7 CHnF	<p>Channel n flag. When channel n is an input capture channel, this read/write bit is set when an active edge occurs on the channel n input. When channel n is an output compare or edge-aligned/center-aligned PWM channel, CHnF is set when the value in the TPM counter registers matches the value in the TPM channel n value registers. When channel n is an edge-aligned/center-aligned PWM channel and the duty cycle is set to 0% or 100%, CHnF is not set even when the value in the TPM counter registers matches the value in the TPM channel n value registers.</p> <p>A corresponding interrupt is requested when this bit is set and channel n interrupt is enabled (CHnIE = 1). Clear CHnF by reading TPMxCnSC while this bit is set and then writing a logic 0 to it. If another interrupt request occurs before the clearing sequence is completed CHnF remains set. This is done so a CHnF interrupt request is not lost due to clearing a previous CHnF.</p> <p>Reset clears this bit. Writing a logic 1 to CHnF has no effect.</p> <p>0 No input capture or output compare event occurred on channel n. 1 Input capture or output compare event on channel n.</p>
6 CHnIE	<p>Channel n interrupt enable. This read/write bit enables interrupts from channel n. Reset clears this bit.</p> <p>0 Channel n interrupt requests disabled (use for software polling). 1 Channel n interrupt requests enabled.</p>
5 MSnB	<p>Mode select B for TPM channel n. When CPWMS is cleared, setting the MSnB bit configures TPM channel n for edge-aligned PWM mode. Refer to the summary of channel mode and setup controls in <a href="#">Table 9-8</a>.</p>

**Table 9-7. TPMxCnSC Field Descriptions (continued)**

Field	Description
4 MSnA	Mode select A for TPM channel n. When CPWMS and MSnB are cleared, the MSnA bit configures TPM channel n for input capture mode or output compare mode. Refer to <a href="#">Table 9-8</a> for a summary of channel mode and setup controls. <b>Note:</b> If the associated port pin is not stable for at least two bus clock cycles before changing to input capture mode, it is possible to get an unexpected indication of an edge trigger.
3–2 ELSnB ELSnA	Edge/level select bits. Depending upon the operating mode for the timer channel as set by CPWMS:MSnB:MSnA and shown in <a href="#">Table 9-8</a> , these bits select the polarity of the input edge that triggers an input capture event, select the level that is driven in response to an output compare match, or select the polarity of the PWM output. If ELSnB and ELSnA bits are cleared, the channel pin is not controlled by TPM. This configuration can be used by software compare only, because it does not require the use of a pin for the channel.

**Table 9-8. Mode, Edge, and Level Selection**

CPWMS	MSnB:MSnA	ELSnB:ELSnA	Mode	Configuration
X	XX	00	Pin is not controlled by TPM. It is reverted to general purpose I/O or other peripheral control	
0	00	01	Input capture	Capture on rising edge only
		10		Capture on falling edge only
		11		Capture on rising or falling edge
	01	00	Output compare	Software compare only
		01		Toggle output on channel match
		10		Clear output on channel match
		11		Set output on channel match
	1X	10	Edge-aligned PWM	High-true pulses (clear output on channel match)
X1		Low-true pulses (set output on channel match)		
1	XX	10	Center-aligned PWM	High-true pulses (clear output on channel match when TPM counter is counting up)
		X1		Low-true pulses (set output on channel match when TPM counter is counting up)

### 9.3.5 TPM Channel Value Registers (TPMxCnVH:TPMxCnVL)

These read/write registers contain the captured TPM counter value of the input capture function or the output compare value for the output compare or PWM functions. The channel registers are cleared by reset.

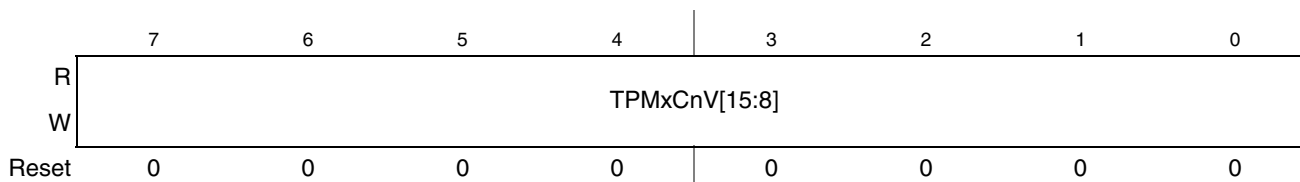
**Figure 9-13. TPM Channel Value Register High (TPMxCnVH)**



**Figure 9-14. TPM Channel Value Register Low (TPMxCnVL)**

In input capture mode, reading either byte (TPMxCnVH or TPMxCnVL) latches the contents of both bytes into a buffer where they remain latched until the other half is read. This latching mechanism also resets (becomes unlatched) when the TPMxCnSC register is written (whether BDM mode is active or not). Any write to the channel registers is ignored during the input capture mode.

When BDM is active, the coherency mechanism is frozen (unless reset by writing to TPMxCnSC register) so the buffer latches remain in the state they were in when the BDM became active, even if one or both halves of the channel register are read while BDM is active. This assures that if you were in the middle of reading a 16-bit register when BDM became active, it reads the appropriate value from the other half of the 16-bit value after returning to normal execution. The value read from the TPMxCnVH and TPMxCnVL registers in BDM mode is the value of these registers and not the value of their read buffer.

In output compare or PWM modes, writing to either byte (TPMxCnVH or TPMxCnVL) latches the value into a buffer. After both bytes were written, they are transferred as a coherent 16-bit value into the timer-channel registers according to the value of CLKSB:CLKSA bits and the selected mode:

- If CLKSB and CLKSA are cleared, the registers are updated when the second byte is written.
- If CLKSB and CLKSA are not cleared and in output compare mode, the registers are updated after the second byte is written and on the next change of the TPM counter (end of the prescaler counting).
- If CLKSB and CLKSA are not cleared and in EPWM or CPWM modes, the registers are updated after both bytes were written, and the TPM counter changes from (TPMxMODH:TPMxMODL – 1) to (TPMxMODH:TPMxMODL). If the TPM counter is a free-running counter, the update is made when the TPM counter changes from 0xFFFFE to 0xFFFF.

The latching mechanism is manually reset by writing to the TPMxCnSC register (whether BDM mode is active or not). This latching mechanism allows coherent 16-bit writes in either big-endian or little-endian order that is friendly to various compiler implementations.

When BDM is active, the coherency mechanism is frozen so the buffer latches remain in the state they were in when the BDM became active even if one or both halves of the channel register are written while BDM is active. Any write to the channel registers bypasses the buffer latches and directly write to the channel register while BDM is active. The values written to the channel register while BDM is active are used for PWM and output compare operation after normal execution resumes. Writes to the channel registers while BDM is active do not interfere with partial completion of a coherency sequence. After the coherency mechanism is fully exercised, the channel registers are updated using the buffered values (while BDM was not active).

## 9.4 Functional Description

All TPM functions are associated with a central 16-bit counter that allows flexible selection of the clock and prescale factor. There is also a 16-bit modulo register associated with this counter.

The CPWMS control bit chooses between center-aligned PWM operation for all channels in the TPM (CPWMS=1) or general purpose timing functions (CPWMS=0) where each channel can independently be configured to operate in input capture, output compare, or edge-aligned PWM mode. The CPWMS control bit is located in the TPM status and control register because it affects all channels within the TPM and influences the way the main counter operates. (In CPWM mode, the counter changes to an up/down mode rather than the up-counting mode used for general purpose timer functions.)

The following sections describe TPM counter and each of the timer operating modes (input capture, output compare, edge-aligned PWM, and center-aligned PWM). Because details of pin operation and interrupt activity depend upon the operating mode, these topics are covered in the associated mode explanation sections.

### 9.4.1 Counter

All timer functions are based on the main 16-bit counter (TPMxCNTH:TPMxCNTL). This section discusses selection of the clock, end-of-count overflow, up-counting vs. up/down counting, and manual counter reset.

#### 9.4.1.1 Counter Clock Source

The 2-bit field, CLKSB:CLKSA, in the timer status and control register (TPMxSC) disables the TPM counter or selects one of three clock sources to TPM counter (Table 9-5). After any MCU reset, CLKSB and CLKSA are cleared so no clock is selected and the TPM counter is disabled (TPM is in a very low power state). You can read or write these control bits at any time. Disabling the TPM counter by writing 00 to CLKSB:CLKSA bits, does not affect the values in the TPM counter or other registers.

The fixed frequency clock is an alternative clock source for the TPM counter that allows the selection of a clock other than the bus clock or external clock. This clock input is defined by chip integration. You can refer chip specific documentation for further information. Due to TPM hardware implementation limitations, the frequency of the fixed frequency clock must not exceed the bus clock frequency. The fixed frequency clock has no limitations for low frequency operation.

The external clock passes through a synchronizer clocked by the bus clock to assure that counter transitions are properly aligned to bus clock transitions. Therefore, in order to meet Nyquist criteria considering also jitter, the frequency of the external clock source must not exceed 1/4 of the bus clock frequency.

When the external clock source is shared with a TPM channel pin, this pin must not be used in input capture mode. However, this channel can be used in output compare mode with ELSnB:ELSnA = 0:0 for software timing functions. In this case, the channel output is disabled, but the channel match events continue to set the appropriate flag.



### 9.4.1.2 Counter Overflow and Modulo Reset

An interrupt flag and enable are associated with the 16-bit main counter. The flag (TOF) is a software-accessible indication that the timer counter has overflowed. The enable signal selects between software polling (TOIE = 0) where no interrupt is generated, or interrupt-driven operation (TOIE = 1) where the interrupt is generated whenever the TOF is set.

The conditions causing TOF to become set depend on whether the TPM is configured for center-aligned PWM (CPWMS = 1). If CPWMS is cleared and there is no modulus limit, the 16-bit timer counter counts from 0x0000 through 0xFFFF and overflows to 0x0000 on the next counting clock. TOF is set at the transition from 0xFFFF to 0x0000. When a modulus limit is set, TOF is set at the transition from the value set in the modulus register to 0x0000. When the TPM is in center-aligned PWM mode (CPWMS = 1), the TOF flag is set as the counter changes direction at the end of the count value set in the modulus register (at the transition from the value set in the modulus register to the next lower count value). This corresponds to the end of a PWM period (the 0x0000 count value corresponds to the center of a period).

### 9.4.1.3 Counting Modes

The main timer counter has two counting modes. When center-aligned PWM is selected (CPWMS = 1), the counter operates in up/down counting mode. Otherwise, the counter operates as a simple up counter. As an up counter, the timer counter counts from 0x0000 through its terminal count and continues with 0x0000. The terminal count is 0xFFFF or a modulus value in TPMxMODH:TPMxMODL.

When center-aligned PWM operation is specified, the counter counts up from 0x0000 through its terminal count and then down to 0x0000 where it changes back to up counting. The terminal count value and 0x0000 are normal length counts (one timer clock period long). In this mode, the timer overflow flag (TOF) is set at the end of the terminal-count period (as the count changes to the next lower count value).

### 9.4.1.4 Manual Counter Reset

The main timer counter can be manually reset at any time by writing any value to TPMxCNTH or TPMxCNTL. Resetting the counter in this manner also resets the coherency mechanism in case only half of the counter was read before resetting the count.

## 9.4.2 Channel Mode Selection

If CPWMS is cleared, MSnB and MSnA bits determine the basic mode of operation for the corresponding channel. Choices include input capture, output compare, and edge-aligned PWM.

### 9.4.2.1 Input Capture Mode

With the input capture function, the TPM can capture the time at which an external event occurs. When an active edge occurs on the pin of an input capture channel, the TPM latches the contents of the TPM counter into the channel-value registers (TPMxCnVH:TPMxCnVL). Rising edges, falling edges, or any edge is chosen as the active edge that triggers an input capture.

In input capture mode, the TPMxCnVH and TPMxCnVL registers are read only.

When either half of the 16-bit capture register is read, the other half is latched into a buffer to support coherent 16-bit accesses in big-endian or little-endian order. The coherency sequence can be manually reset by writing to TPMxCnSC.

An input capture event sets a flag bit (CHnF) that optionally generates a CPU interrupt request.

While in BDM, the input capture function works as configured. When an external event occurs, the TPM latches the contents of the TPM counter (frozen because of the BDM mode) into the channel value registers and sets the flag bit.

### 9.4.2.2 Output Compare Mode

With the output compare function, the TPM can generate timed pulses with programmable position, polarity, duration, and frequency. When the counter reaches the value in TPMxCnVH:TPMxCnVL registers of an output compare channel, the TPM can set, clear, or toggle the channel pin.

Writes to any of TPMxCnVH and TPMxCnVL registers actually write to buffer registers. In output compare mode, the TPMxCnVH:TPMxCnVL registers are updated with the value of their write buffer only after both bytes were written and according to the value of CLKSB:CLKSA bits:

- If CLKSB and CLKSA are cleared, the registers are updated when the second byte is written
- If CLKSB and CLKSA are not cleared, the registers are updated at the next change of the TPM counter (end of the prescaler counting) after the second byte is written.

The coherency sequence can be manually reset by writing to the channel status/control register (TPMxCnSC).

An output compare event sets a flag bit (CHnF) that optionally generates a CPU interrupt request.

### 9.4.2.3 Edge-Aligned PWM Mode

This type of PWM output uses the normal up-counting mode of the timer counter (CPWMS=0) and can be used when other channels in the same TPM are configured for input capture or output compare functions. The period of this PWM signal is determined by the value of the modulus register (TPMxMODH:TPMxMODL) plus 1. The duty cycle is determined by the value of the timer channel register (TPMxCnVH:TPMxCnVL). The polarity of this PWM signal is determined by ELSnA bit. 0% and 100% duty cycle cases are possible.

The time between the modulus overflow and the channel match value (TPMxCnVH:TPMxCnVL) is the pulse width or duty cycle ([Figure 9-15](#)). If ELSnA is cleared, the counter overflow forces the PWM signal high, and the channel match forces the PWM signal low. If ELSnA is set, the counter overflow forces the PWM signal low, and the channel match forces the PWM signal high.

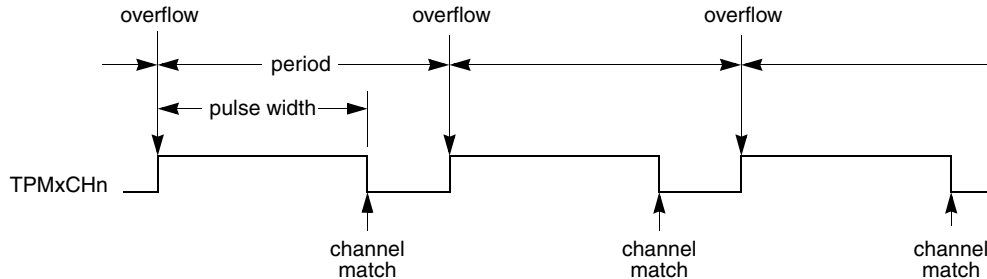

**Figure 9-15. EPWM period and pulse width (ELSnA=0)**

When the channel value register is set to 0x0000, the duty cycle is 0%. A 100% duty cycle is achieved by setting the timer-channel register (TPMxCnVH:TPMxCnVL) to a value greater than the modulus setting. This implies that the modulus setting must be less than 0xFFFF in order to get 100% duty cycle.

The timer channel registers are buffered to ensure coherent 16-bit updates and to avoid unexpected PWM pulse widths. Writes to any of the registers TPMxCnVH and TPMxCnVL actually write to buffer registers. In edge-aligned PWM mode, the TPMxCnVH:TPMxCnVL registers are updated with the value of their write buffer according to the value of CLKSB:CLKSA bits:

- If CLKSB and CLKSA are cleared, the registers are updated when the second byte is written
- If CLKSB and CLKSA are not cleared, the registers are updated after both bytes were written, and the TPM counter changes from (TPMxMODH:TPMxMODL – 1) to (TPMxMODH:TPMxMODL). If the TPM counter is a free-running counter, the update is made when the TPM counter changes from 0xFFFE to 0xFFFF.

#### 9.4.2.4 Center-Aligned PWM Mode

This type of PWM output uses the up/down counting mode of the timer counter (CPWMS=1). The channel match value in TPMxCnVH:TPMxCnVL determines the pulse width (duty cycle) of the PWM signal while the period is determined by the value in TPMxMODH:TPMxMODL. TPMxMODH:TPMxMODL must be kept in the range of 0x0001 to 0x7FFF because values outside this range can produce ambiguous results. ELSnA determines the polarity of the CPWM signal.

$$\text{pulse width} = 2 \times (\text{TPMxCnVH:TPMxCnVL})$$

$$\text{period} = 2 \times (\text{TPMxMODH:TPMxMODL}); \text{TPMxMODH:TPMxMODL} = 0x0001\text{--}0x7FFF$$

If TPMxCnVH:TPMxCnVL is zero or negative (bit 15 set), the duty cycle is 0%. If TPMxCnVH:TPMxCnVL is a positive value (bit 15 clear) and is greater than the non-zero modulus setting, the duty cycle is 100% because the channel match never occurs. This implies the usable range of periods set by the modulus register is 0x0001 through 0x7FFE (0x7FFF if you do not need to generate 100% duty cycle). This is not a significant limitation. The resulting period is much longer than required for normal applications.

All zeros in TPMxMODH:TPMxMODL is a special case that must not be used with center-aligned PWM mode. When CPWMS is cleared, this case corresponds to the counter running free from 0x0000 through 0xFFFF. When CPWMS is set, the counter needs a valid match to the modulus register somewhere other than at 0x0000 in order to change directions from up-counting to down-counting.

The channel match value in the TPM channel registers (times two) determines the pulse width (duty cycle) of the CPWM signal (Figure 9-16). If ELSnA is cleared, a channel match occurring while counting up clears the CPWM output signal and a channel match occurring while counting down sets the output. The counter counts up until it reaches the modulo setting in TPMxMODH:TPMxMODL, then counts down until it reaches zero. This sets the period equal to two times TPMxMODH:TPMxMODL.

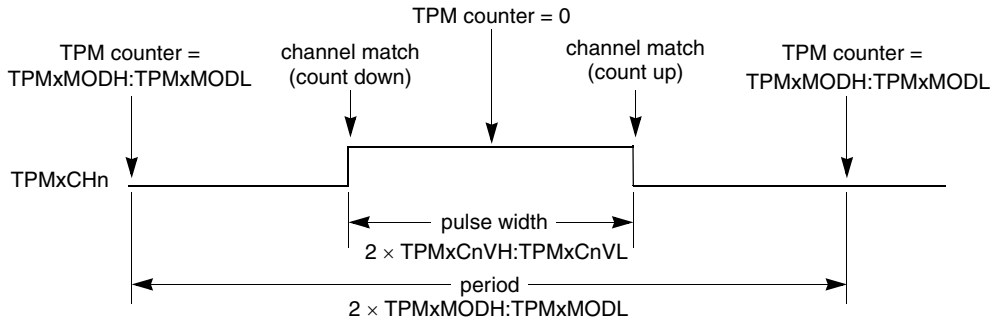

**Figure 9-16. CPWM period and pulse width (ELSnA=0)**

Center-aligned PWM outputs typically produce less noise than edge-aligned PWMs because fewer I/O pin transitions are lined up at the same system clock edge. This type of PWM is also required for some types of motor drives.

Input capture, output compare, and edge-aligned PWM functions do not make sense when the counter is operating in up/down counting mode so this implies that all active channels within a TPM must be used in CPWM mode when CPWMS is set.

The timer channel registers are buffered to ensure coherent 16-bit updates and to avoid unexpected PWM pulse widths. Writes to any of the registers TPMxCnVH and TPMxCnVL actually write to buffer registers. In center-aligned PWM mode, the TPMxCnVH:TPMxCnVL registers are updated with the value of their write buffer according to the value of CLKSB:CLKSA bits:

- If CLKSB and CLKSA are cleared, the registers are updated when the second byte is written
- If CLKSB and CLKSA are not cleared, the registers are updated after both bytes were written, and the TPM counter changes from (TPMxMODH:TPMxMODL – 1) to (TPMxMODH:TPMxMODL). If the TPM counter is a free-running counter, the update is made when the TPM counter changes from 0xFFFE to 0xFFFF.

When TPMxCNTH:TPMxCNTL equals TPMxMODH:TPMxMODL, the TPM can optionally generate a TOF interrupt (at the end of this count).

## 9.5 Reset Overview

### 9.5.1 General

The TPM is reset whenever any MCU reset occurs.

## 9.5.2 Description of Reset Operation

Reset clears TPMxSC that disables TPM counter clock and overflow interrupt (TOIE=0). CPWMS, MSnB, MSnA, ELSnB, and ELSnA are all cleared. This configures all TPM channels for input capture operation and the associated pins are not controlled by TPM.

## 9.6 Interrupts

### 9.6.1 General

The TPM generates an optional interrupt for the main counter overflow and an interrupt for each channel. The meaning of channel interrupts depends on each channel's mode of operation. If the channel is configured for input capture, the interrupt flag is set each time the selected input capture edge is recognized. If the channel is configured for output compare or PWM modes, the interrupt flag is set each time the main timer counter matches the value in the 16-bit channel value register.

All TPM interrupts are listed in [Table 9-9](#).

**Table 9-9. Interrupt Summary**

Interrupt	Local Enable	Source	Description
TOF	TOIE	Counter overflow	Set each time the TPM counter reaches its terminal count (at transition to its next count value)
CHnF	CHnIE	Channel event	An input capture event or channel match took place on channel n

The TPM module provides high-true interrupt signals.

### 9.6.2 Description of Interrupt Operation

For each interrupt source in the TPM, a flag bit is set upon recognition of the interrupt condition such as timer overflow, channel input capture, or output compare events. This flag is read (polled) by software to determine that the action has occurred, or an associated enable bit (TOIE or CHnIE) can be set to enable the interrupt generation. While the interrupt enable bit is set, the interrupt is generated whenever the associated interrupt flag is set. Software must perform a sequence of steps to clear the interrupt flag before returning from the interrupt-service routine.

TPM interrupt flags are cleared by a two-step process including a read of the flag bit while it is set followed by a write of zero to the bit. If a new event is detected between these two steps, the sequence is reset and the interrupt flag remains set after the second step to avoid the possibility of missing the new event.

## 9.6.2.1 Timer Overflow Interrupt (TOF) Description

The meaning and details of operation for TOF interrupts varies slightly depending upon the mode of operation of the TPM system (general purpose timing functions versus center-aligned PWM operation). The flag is cleared by the two step sequence described above.

### 9.6.2.1.1 Normal Case

When CPWMS is cleared, TOF is set when the timer counter changes from the terminal count (the value in the modulo register) to 0x0000. If the TPM counter is a free-running counter, the update is made when the TPM counter changes from 0xFFFF to 0x0000.

### 9.6.2.1.2 Center-Aligned PWM Case

When CPWMS is set, TOF is set when the timer counter changes direction from up-counting to down-counting at the end of the terminal count (the value in the modulo register).

## 9.6.2.2 Channel Event Interrupt Description

The meaning of channel interrupts depends on the channel's current mode (input capture, output compare, edge-aligned PWM, or center-aligned PWM).

### 9.6.2.2.1 Input Capture Events

When a channel is configured as an input capture channel, the ELSnB:ELSnA bits select if channel pin is not controlled by TPM, rising edges, falling edges, or any edge as the edge that triggers an input capture event. When the selected edge is detected, the interrupt flag is set. The flag is cleared by the two-step sequence described in [Section 9.6.2, "Description of Interrupt Operation."](#)

### 9.6.2.2.2 Output Compare Events

When a channel is configured as an output compare channel, the interrupt flag is set each time the main timer counter matches the 16-bit value in the channel value register. The flag is cleared by the two-step sequence described in [Section 9.6.2, "Description of Interrupt Operation."](#)

### 9.6.2.2.3 PWM End-of-Duty-Cycle Events

When the channel is configured for edge-aligned PWM, the channel flag is set when the timer counter matches the channel value register that marks the end of the active duty cycle period. When the channel is configured for center-aligned PWM, the timer count matches the channel value register twice during each PWM cycle. In this CPWM case, the channel flag is set at the start and at the end of the active duty cycle period when the timer counter matches the channel value register. The flag is cleared by the two-step sequence described in [Section 9.6.2, "Description of Interrupt Operation."](#)

## Chapter 10

# Interrupt Priority Controller (S08IPCV1)

### 10.1 Introduction

The interrupt priority controller (IPC) provides hardware based nested interrupt mechanism in HCS08 MCUs. It allows all prioritized interrupt being interrupted except software interrupt.

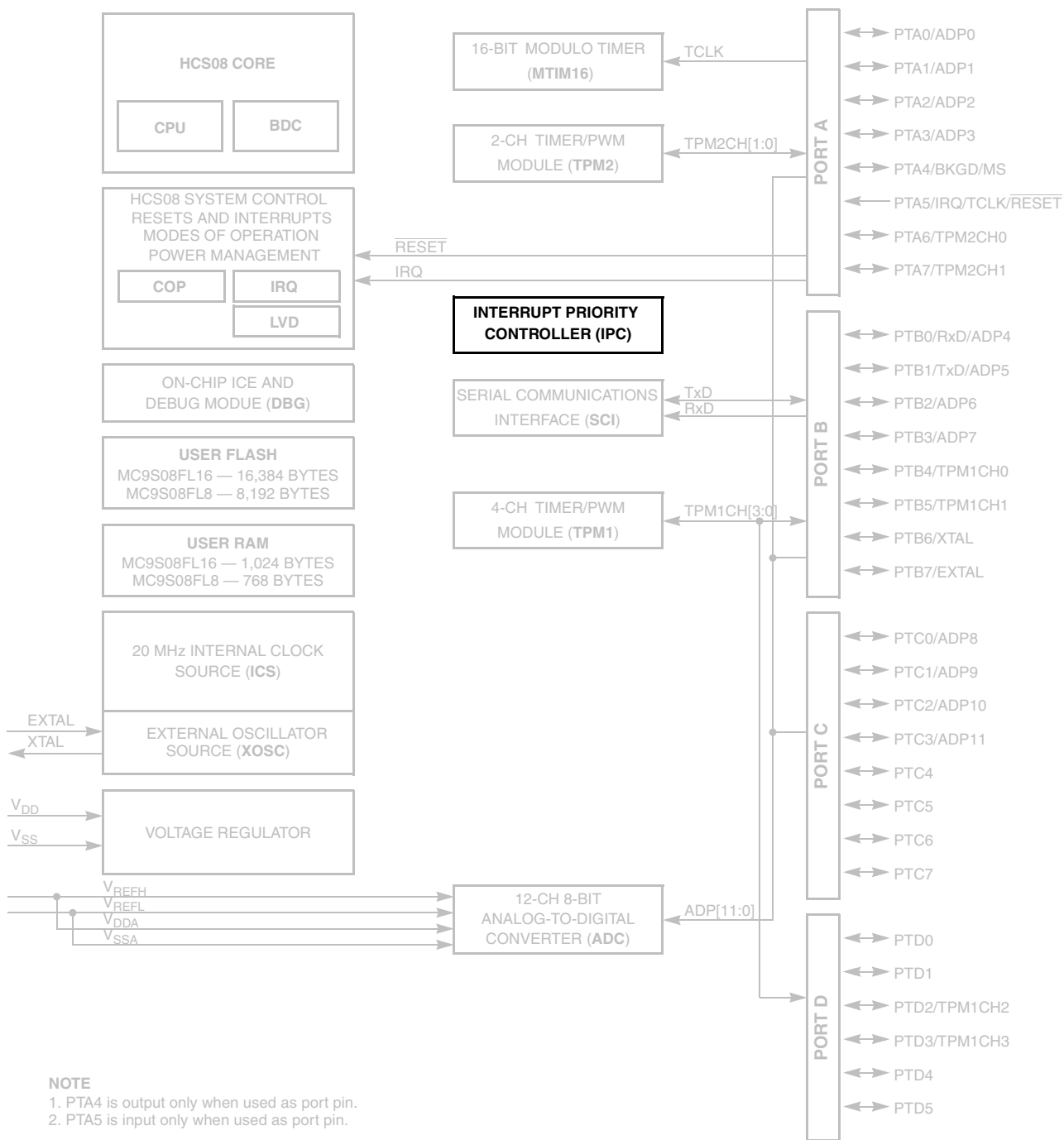

Figure 10-1. MC9S08FL16 Series Block Diagram Highlighting IPC Module



## 10.1.1 Features

The interrupt priority controller (IPC) includes the following features:

- Four-level programmable interrupt priority for each interrupt source
- Support for prioritized preemptive interrupt service routines
  - Lower priority interrupt requests are blocked when higher priority interrupts are being serviced
  - Higher or equal priority level interrupt requests can preempt lower priority interrupts being serviced
- Automatic update of interrupt priority mask with being serviced interrupt source priority level when the interrupt vector is being fetched
- Interrupt priority mask can be modified during main flow or interrupt service execution
- Previous interrupt mask level is automatically stored when interrupt vector is fetched (four levels of previous values accommodated)

## 10.1.2 Modes of Operation

### 10.1.2.1 Run Mode

In run mode, if the IPC is enabled, interrupt requests are qualified against interrupt mask register and unique interrupt level register before being sent to the CPU. If the IPC is disabled, the module is inactive and is transparently allowing interrupt requests to pass to HCS08 CPU, no programmable priority or priority preemptive interrupt is supported.

### 10.1.2.2 Wait Mode

In wait mode, the IPC module acts as it does in run mode.

### 10.1.2.3 Stop Mode

In stop3 mode, the interrupt mask is set to 0 and the IPC module is bypassed. The IPC interrupt mask value upon the stop3 entry is automatically restored when exiting stop3. This ensures that asynchronous interrupt can still wake up CPU from stop3 mode.

If the stop3 exits with an interrupt, the IPC will continue to working with previous setting; If the stop3 exits with a reset, the IPC will return to its reset state.

In stop2 and stop1 mode, the IPC module is powered off, the MCU works as the module is not there. Upon the exiting of stop2 and stop1, the IPC module is reset.

## 10.1.3 Block Diagram

Figure 10-2 is the block diagram of the interrupt priority controller module (IPC).

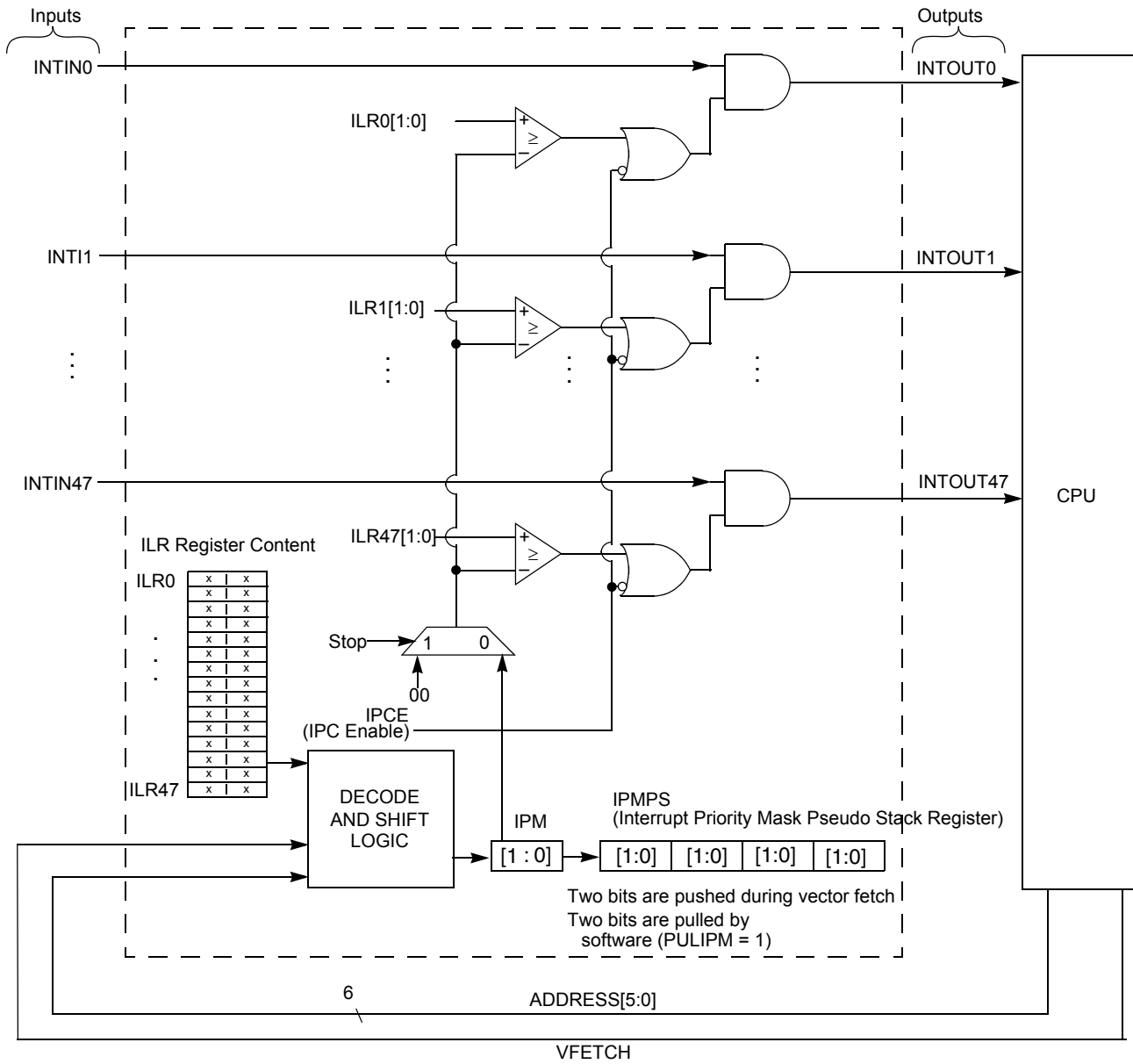

Figure 10-2. Interrupt Priority Controller (IPC) Block Diagram

## 10.2 External Signal Description

Table 10-1. Signal Properties

Name	Port	Function	Reset State	Pull Up
INTIN[47:2]	N/A	Interrupt source interrupt request input	Input	N/A
VFETCH	N/A	Vector fetch indicator from HCS08 CPU	Input	N/A
IADB[5:0]	N/A	Address bus input from HCS08 CPU	Input	N/A
INTOUT[47:2]	N/A	Interrupt request to HCS08 CPU	Output	N/A

### 10.2.1 INTIN[47:0] — Interrupt Source Interrupt Request Input

Input from interrupt sources.

### 10.2.2 VFETCH — Vector Fetch Indicator from HCS08 CPU

Vector fetch signal generated from HCS08 CPU.

### 10.2.3 IADB[5:0] — Address Bus Input from HCS08 CPU

Internal address bus used to decode the IPC registers.

### 10.2.4 INTOUT[47:0] — Interrupt Request to HCS08 CPU

Interrupt output signals to HCS08 CPU.

## 10.3 Register Definition

### 10.3.1 IPC Status and Control Register (IPCSC)

This register contains status and control bits for the IPC.

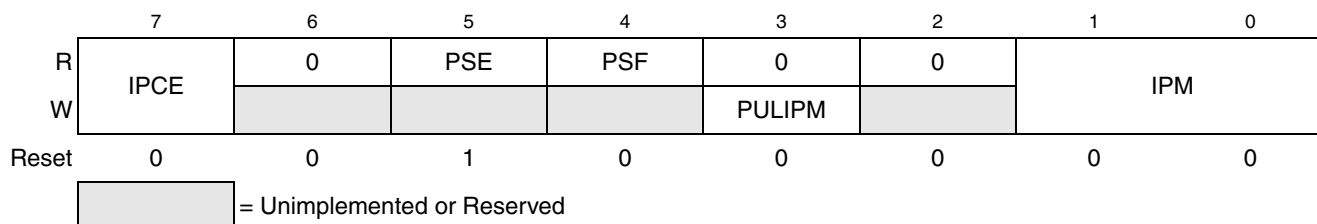

Figure 10-3. IPC Status and Control Register (IPCSC)

Table 10-2. IPCSC Field Descriptions

Field	Description
7 IPCE	<b>Interrupt Priority Controller Enable</b> — This bit enables/disables the interrupt priority controller module. 0 Disables IPCE. Interrupt generated from the interrupt source is passed directly to CPU without processing. (Bypass mode) The IPMPS register is not updated when the module is disabled. 1 Enables IPCE and interrupt generated from the interrupt source is processed by IPC before passing to CPU.
5 PSE	<b>Pseudo Stack Empty</b> — This bit indicates that the pseudo stack has no valid information. This bit is automatically updated after each IPMPS register push or pull operation.
4 PSF	<b>Pseudo Stack Full</b> — This bit indicates that the pseudo stack register IPMPS register is full. It is automatically updated after each IPMPS register push or pull operation. If additional interrupt is nested after this bit is set, the earliest interrupt mask value(IPM0[1:0]) stacked in IPMPS will be lost. 0 IPMPS register is not full. 1 IPMPS register is full.

**Table 10-2. IPCSC Field Descriptions (continued)**

Field	Description
3 PULIPM	<b>Pull IPM from IPMPS</b> — This bit pulls stacked IPM value from IPMPS register to IPM bits of IPCSC. Zeros are shifted into bit positions 1 and 0 of IPMPS. 0 No operation. 1 Writing 1 to this bit causes a 2-bit value from the interrupt priority mask pseudo stack register to be pulled to the IPM bits of IPCSC to restore the previous IPM value.
1:0 IPM	<b>Interrupt Priority Mask</b> — This field sets the mask for the interrupt priority control. If the interrupt priority controller is enabled, the interrupt source with interrupt level (ILRxx) value which is greater than or equal to the value of IPM will be presented to the CPU. Writes to this field are allowed, but doing this will not push information to the IPMPS register. Writing IPM with PULIPM setting when IPCE is already set, the IPM will restore the value pulled from the IPMPS register, not the value written to the IPM register

### 10.3.2 Interrupt Priority Mask Pseudo Stack Register (IPMPS)

This register is used to store the previous interrupt priority mask level temporarily while the currently active interrupt is executed.

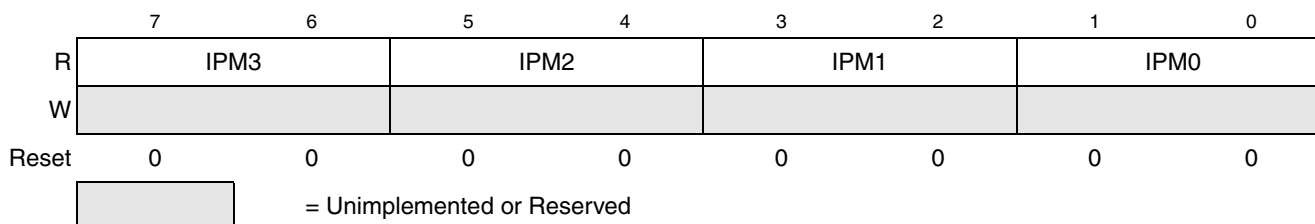

**Figure 10-4. Interrupt Priority Mask Pseudo Stack Register (IPMR)**

**Table 10-3. IPMPS Positions 0–3 Field Descriptions**

Field	Description
7:6 IPM3	<b>Interrupt Priority Mask pseudo stack position 3</b> — This field is the pseudo stack register for IPM3. The most recent information is stored in IPM3.
5:4 IPM2	<b>Interrupt Priority Mask pseudo stack position 2</b> — This field is the pseudo stack register for IPM2.
3:2 IPM1	<b>Interrupt Priority Mask pseudo stack position 1</b> — This field is the pseudo stack register for IPM1.
1:0 IPM0	<b>Interrupt Priority Mask pseudo stack position 0</b> — This field is the pseudo stack register for IPM0.

### 10.3.3 Interrupt Level Setting Registers (ILRS0–ILRS11)

This set of registers (ILRS0–ILRS11) contains the user specified interrupt level for each interrupt source. In Figure 10-5, x indicates the number of the register (ILRSx is ILRS0 through ILRS11). Also, n is the field number (ILRn is ILR0 through ILR47). Refer to Table 10-4.

**Table 10-4. Interrupt Level Register Fields**

	7	6	5	4	3	2	1	0
ILRS0	ILR3		ILR2		ILR1		ILR0	
ILRS1	ILR7		ILR6		ILR5		ILR4	
ILRS2	ILR11		ILR10		ILR9		ILR8	
ILRS3	ILR15		ILR14		ILR13		ILR12	
ILRS4	ILR19		ILR18		ILR17		ILR16	
ILRS5	ILR23		ILR22		ILR21		ILR20	
ILRS6	ILR27		ILR26		ILR25		ILR24	
ILRS7	ILR31		ILR30		ILR29		ILR28	
ILRS8	ILR34		ILR34		ILR33		ILR32	
ILRS9	ILR39		ILR38		ILR37		ILR36	
ILRS10	ILR43		ILR42		ILR41		ILR40	
ILRS11	ILR47		ILR46		ILR45		ILR44	

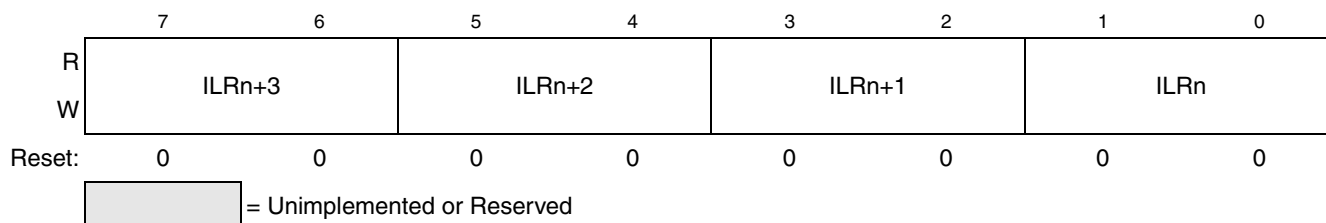

**Figure 10-5. Interrupt Level Register Set ILRx (ILRS0–ILRS11)**

**Table 10-5. Interrupt Level Registers**

Field	Description
7:6 ILRn+3	<b>Interrupt Level Register for Source n+3</b> — This field sets the interrupt level for interrupt source n+3.
5:4 ILRn+2	<b>Interrupt Level Register for Source n+2</b> — This field sets the interrupt level for interrupt source n+2.
3:2 ILRn+1	<b>Interrupt Level Register for Source n+1</b> — This field sets the interrupt level for interrupt source n+1.
1:0 ILRn	<b>Interrupt Level Register for Source n</b> — This field sets the interrupt level for interrupt source n.

The number of ILRS registers is parameterized in the design, the number can be 4, 6, 8, 10 and 12 based on the actual interrupt number in the design. The corresponding interrupt number is 16, 24, 32, 40 and 48 separately.

## 10.4 Functional Description

The IPC works with the existing HCS08 interrupt mechanism to allow nestable interrupts with programmable priority levels. This module also allows implementation of preemptive interrupt according to the programmed interrupt priority with minimal software overhead. The IPC consists of three major functional blocks.

- The interrupt priority level registers
- The interrupt priority level comparator set
- The interrupt mask register update and restore mechanism

### 10.4.1 Interrupt Priority Level Register

This set of registers is associated with the interrupt sources to the HCS08 CPU. Each interrupt priority level is a 2-bit value such that a user can program the interrupt priority level of each source to priority 0, 1, 2, or 3. Level 3 has the highest priority while level 0 has the lowest. Software can read or write to these registers at any time. The interrupt priority level comparator set, interrupt mask register update, and restore mechanism use this information.

### 10.4.2 Interrupt Priority Level Comparator Set

When the module is enabled, an active interrupt request forces a comparison between the corresponding ILR and the 2-bit interrupt mask IPM[1:0](in stop3 mode, the IPM[1:0] is substituted by value 0x00). If the ILR value is greater than or equal to the value of the interrupt priority mask (IPM bits in IPCSC), the corresponding interrupt out (INTOUT) signal will be asserted and will signal an interrupt request to the HCS08 CPU.

When the module is disabled, the interrupt request signal from the source is directly passed to the CPU.

Because the IPC is an external module, the interrupt priority level programmed in the interrupt priority register will not affect the inherent interrupt priority arbitration as defined by the HCS08 CPU. Therefore, if two (or more) interrupts are present in the HCS08 CPU at the same time, the inherent priority in HCS08 CPU will perform arbitration by the inherent interrupt priority.

### 10.4.3 Interrupt Priority Mask Update and Restore Mechanism

The interrupt priority mask (IPM) is 2-bits located in the least significant end of IPCSC register. This two bits controls which interrupt is allowed to be presented to the HCS08 CPU. During vector fetch, the interrupt priority mask is updated automatically with the value of the ILR corresponding to that interrupt source. The original value of the IPM will be saved onto IPMPS for restoration after the interrupt service routine completes execution. When the interrupt service routine completes execution, the user restore the original value of IPM by writing 1 to the PULIPM bit. In both cases, the IPMPS is a shift register functioning as a pseudo stack register for storing the IPM. When the IPM is updated, the original value is shifted into IPMPS. The IPMPS can store four levels of IPM. If the last position of IPMPS is written, the PSF flag indicates that the IPMPS is full. If all the values in the IPMPS were read, the PSE flag indicates that the IPMPS is empty.

## 10.4.4 The Integration and Application of the IPC

All the interrupt inputs coming from peripheral modules are synchronous signals. None of asynchronous signals of the interrupts are routed to IPC. The asynchronous signals of the interrupts are routed directly to SIM module to wake up system clocks in stop3 mode.

Additional care should be exercised when IRQ is re-prioritized by IPC. CPU instructions BIL and BIH need input from IRQ pin. If IRQ interrupt is masked, BIL and BIH still work but the IRQ interrupt will not occur.

## 10.5 Application Examples

Figure 10-6 and Figure 10-7 are the examples of the IPC operation at interrupt entry and exiting.

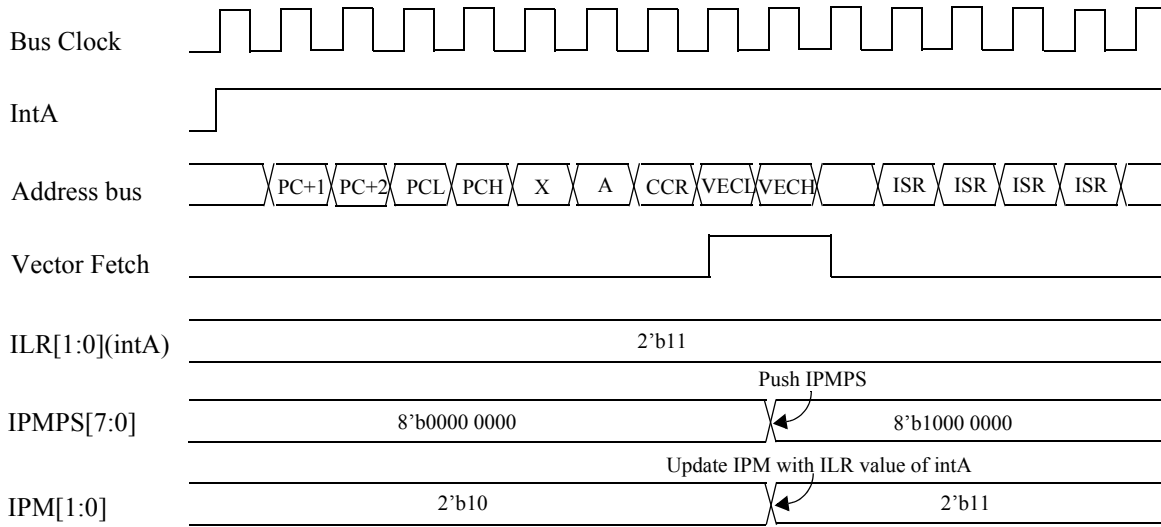

Figure 10-6. IPC Operation at Interrupt Entry

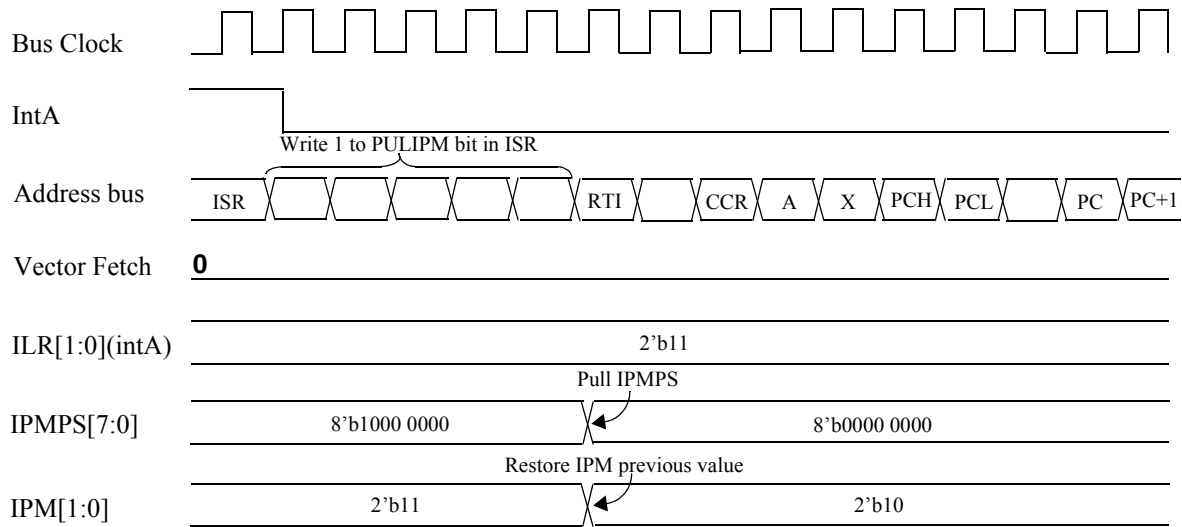

Figure 10-7. IPC Operation at Interrupt Exiting



## 10.6 Initialization/Application Information

- The interrupt priority controller must be enabled to function. While inside an interrupt service routine, some work has to be done to enable other higher priority interrupts. The following is a pseudo code per example written in assembly language:

```

INT_SER :
    BCLR     INTFLAG, INTFLAG_R ; clear flag that generate interrupt
    .
    .
    .
    .
    .
    CLI      ; global interrupt enable and nested interrupt enabled
    .
    .
    .
    BSET     PULIPM, PULIPM_R ; restore the old IPM value before leaving
    RTI
    
```

- A minimum overhead of six bus clock cycles is added inside an interrupt services routine to enable preemptive interrupts.
- As interrupt of same priority level is allowed to pass through IPC to HCS08 CPU thus the flag generating the interrupt should be cleared before doing CLI to enable preemptive interrupts.
- The IPM is automatically updated to the level the interrupt is servicing and the original level is kept in IPMPS. Watch out for the full (PSF) bit if nesting for more than 4 level is expected.
- Before leaving the interrupt service routine, the previous levels should be restored manually by setting PULIPM bit. Watch out for the full (PSF) bit and empty (PSE) bit.



# Chapter 11

## 16-Bit Modulo Timer (S08MTIM16V1)

### 11.1 Introduction

MC9S08FL16 series contain a 16-bit modulo timer (MTIM16), which is an extended of 8-bit MTIM in previous S08 families. The 16-bit MTIM counts and overflows when the counter value matches the modulo value. By software configuration, an interrupt is triggered when overflow occurs.

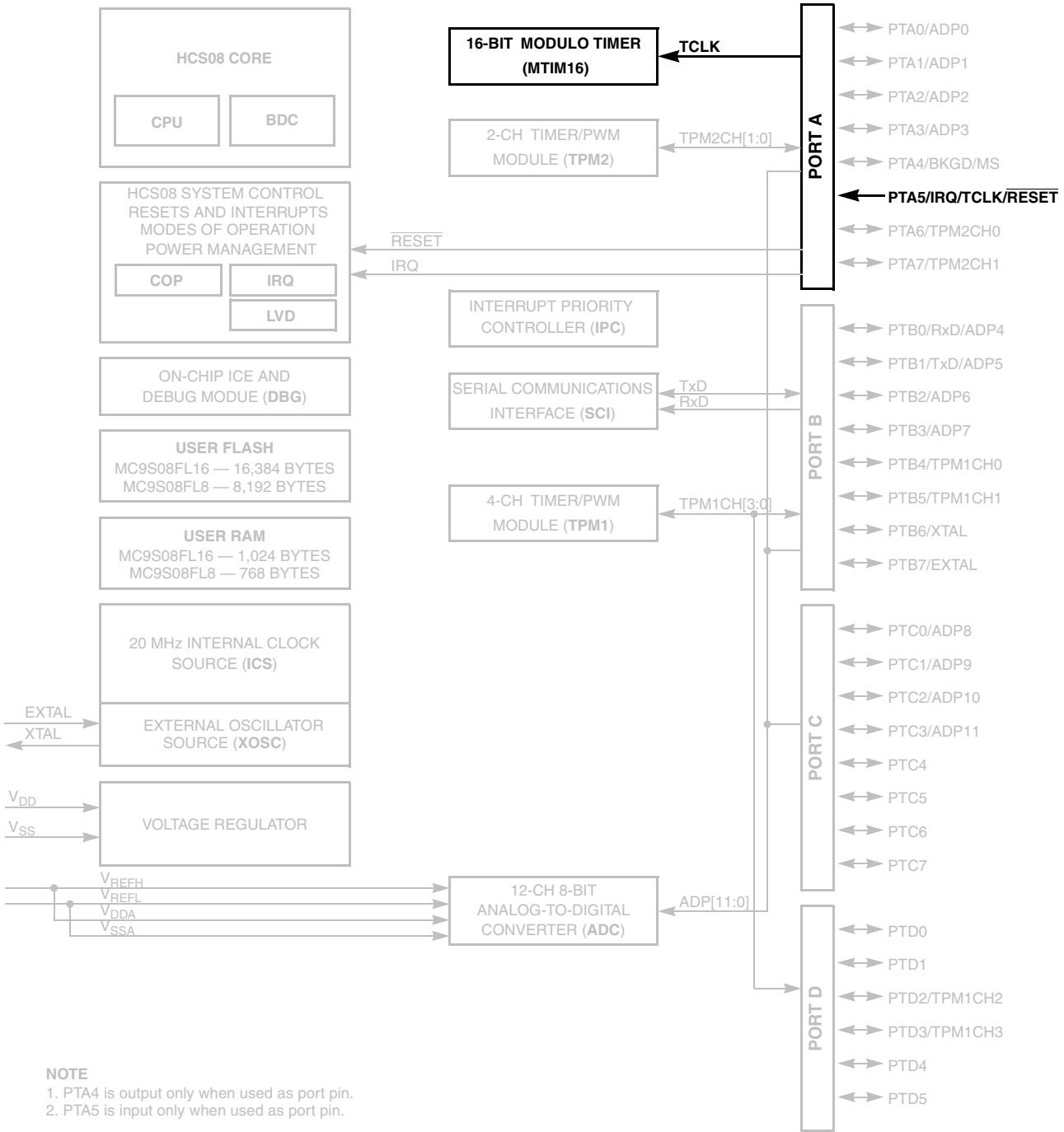

Figure 11-1. MC9S08FL16 Series Block Diagram Highlighting MTIM16 Module and Pin

## 11.2 Features

Timer system features include:

- 16-bit up-counter
  - Free-running or 16-bit modulo limit
  - Software controllable interrupt on overflow
  - Counter reset bit (TRST)
  - Counter stop bit (TSTP)
- Four software selectable clock sources for input to prescaler:
  - System bus clock — rising edge
  - Fixed frequency clock (XCLK) — rising edge
  - External clock source on the TCLK pin — rising edge
  - External clock source on the TCLK pin — falling edge
- Nine selectable clock prescale values:
  - Clock source divide by 1, 2, 4, 8, 16, 32, 64, 128, or 256
- Modulo compare matched can be an output

### 11.2.1 Block Diagram

The block diagram for the modulo timer module is shown [Figure 11-2](#).

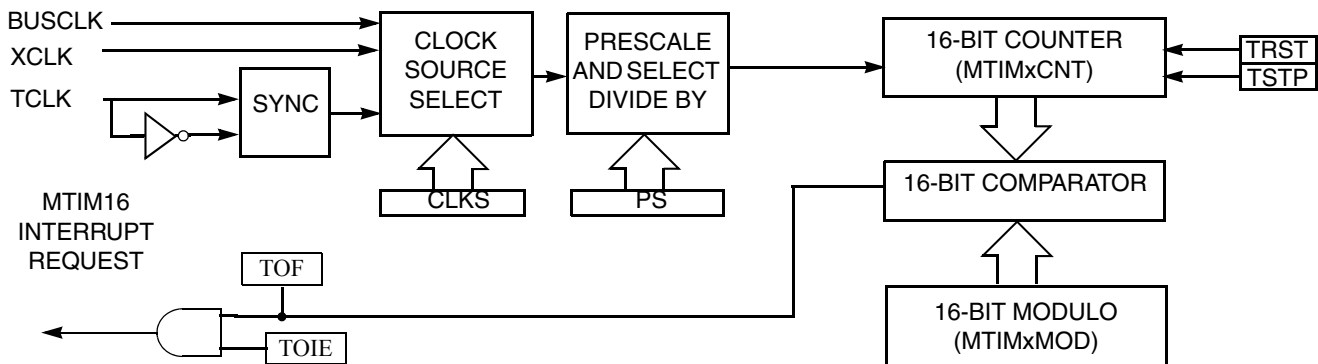

Figure 11-2. Modulo Timer (S08MTIM16) Block Diagram

### 11.2.2 Modes of Operation

This section defines MTIM16 operation in stop, wait, and background debug modes.

#### 11.2.2.1 MTIM16 in Wait Mode

The MTIM16 continues to run in wait mode if enabled prior to the execution of the WAIT instruction. The timer overflow interrupt brings the MCU out of wait mode if it is enabled. For lowest possible current

consumption, the MTIM16 should be stopped by software if it is not needed as an interrupt source during wait mode.

### 11.2.2.2 MTIM16 in Stop Modes

The MTIM16 is disabled in all stop modes, regardless of the settings before executing the STOP instruction. Therefore, the MTIM16 cannot be used as a wake up source from stop mode.

Upon waking from stop2 mode, the MTIM16 will enter its reset state. If stop3 is exited with a reset, the MTIM16 will enter its reset state. If stop3 is exited with an interrupt, the MTIM16 continues from the state it was in stop3. If the counter was active upon entering stop3, the count will resume from the current value.

### 11.2.2.3 MTIM16 in Active Background Mode

The MTIM16 stops all counting until the microcontroller returns to normal user operating mode. Counting resumes from the suspended value as long as an MTIM16 reset did not occur (TRST written to a 1).

## 11.3 External Signal Description

### 11.3.1 TCLK — External Clock Source Input into MTIM16

The MTIM16 includes one external signal, TCLK, used to input an external clock when selected as the MTIM16 clock source. The signal properties of TCLK are shown in [Table 11-1](#).

**Table 11-1. Signal Properties**

Signal	Function	I/O
TCLK	External clock source input into MTIM16	I

The TCLK input must be synchronized by the bus clock. Also, variations in duty cycle and clock jitter must be accommodated. As a result, the TCLK signal must be limited to one-fourth of the bus frequency.

The TCLK pin can be muxed with a general-purpose port pin. See [Chapter 2, “Pins and Connections”](#) for the pin location and priority of this function.

## 11.4 Register Definition

Each MTIM16 includes four registers:

- An 8-bit status and control register
- An 8-bit clock configuration register
- A 16-bit counter register

A 16-bit modulo register. [Figure 11-3](#) is a summary of MTIM16 registers.

**Figure 11-3. MTIM16 Register Summary**

Name		7	6	5	4	3	2	1	0
MTIMSC	R	TOF	TOIE	0	TSTP	0	0	0	0
	W			TRST					
MTIMCLK	R	0	0	CLKS		PS			
	W								
MTIMCNTH	R	CNTH							
	W								
MTIMCNTL	R	CNTL							
	W								
MTIMMODH	R	MODH							
	W								
MTIMMODL	R	MODL							
	W								

Refer to the direct-page register summary in the Memory chapter for the absolute address assignments for all MTIM16 registers. This section refers to registers and control bits only by their names and relative address offsets.

Some MCUs may have more than one MTIM16, so register names include placeholder characters to identify the correct MTIM16.

### 11.4.1 MTIM16 Status and Control Register (MTIMSC)

MTIMSC contains the overflow status flag and control bits. These are used to configure the interrupt enable, reset the counter, and stop the counter.

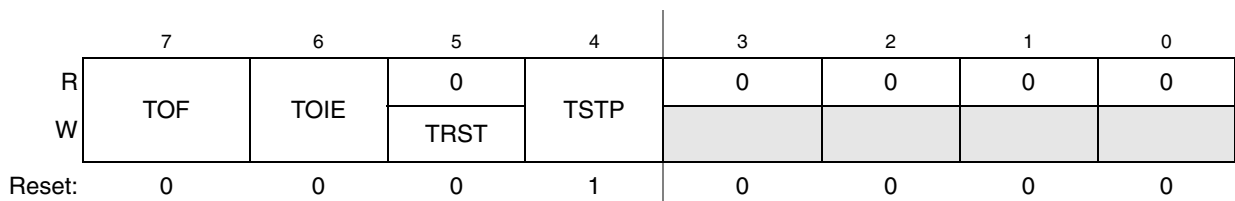

**Figure 11-4. MTIM16 Status and Control Register (MTIMSC)**

**Table 11-2. MTIMSC Register Field Descriptions**

Field	Description
7 TOF	<b>MTIM16 Overflow Flag</b> — This bit is set when the MTIM16 counter register overflows to 0x0000 after reaching the value in the MTIM16 modulo register. Clear TOF by reading the MTIMSC register while TOF is set, then writing a 0 to TOF. Writing a 1 has not effect. TOF is also cleared when TRST is written to a 1. 0 MTIM16 counter has not reached the overflow value in the MTIM16 modulo register. 1 MTIM16 counter has reached the overflow value in the MTIM16 modulo register.
6 TOIE	<b>MTIM16 Overflow Interrupt Enable</b> — This read/write bit enables MTIM16 overflow interrupts. If TOIE is set, then an interrupt is generated when TOF = 1. Reset clears TOIE. Do not set TOIE if TOF = 1. Clear TOF first, then set TOIE. 0 TOF interrupts are disabled. Use software polling. 1 TOF interrupts are enabled.
5 TRST	<b>MTIM16 Counter Reset</b> — When an 1 is written to this write-only bit, the MTIM16 counter register resets to 0x0000 and TOF is cleared. Writing an 1 to this bit also makes the modulo value to take effect at once. Reading this bit always returns 0. 0 No effect. MTIM16 counter remains in its current state. 1 MTIM16 counter is reset to 0x0000.
4 TSTP	<b>MTIM16 Counter Stop</b> — When set, this read/write bit stops the MTIM16 counter at its current value. Counting resumes from the current value when TSTP is cleared. Reset sets TSTP to prevent the MTIM16 from counting. 0 MTIM16 counter is active. 1 MTIM16 counter is stopped.
3:0	Unused register bits, always read 0.

### 11.4.2 MTIM16 Clock Configuration Register (MTIMCLK)

MTIMCLK contains the clock select bits (CLKS) and the prescaler select bits (PS).

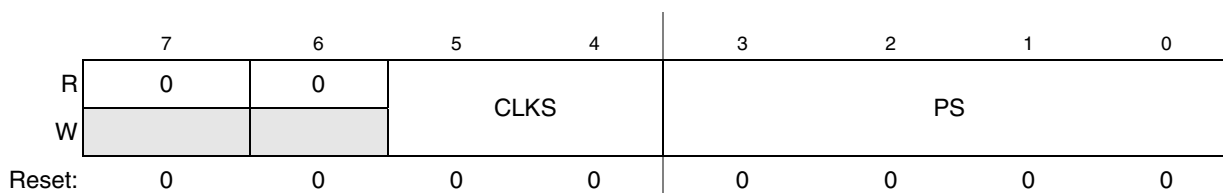

**Figure 11-5. MTIM16 Clock Configuration Register (MTIMCLK)**

**Table 11-3. MTIMCLK Register Field Description**

Field	Description
7:6	Unused register bits, always read 0.

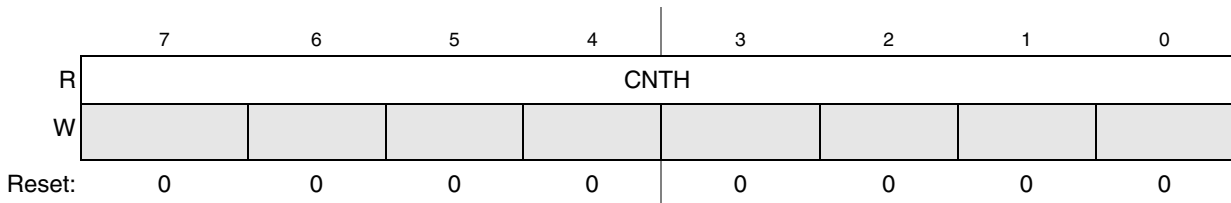

**Table 11-3. MTIMCLK Register Field Description (continued)**

Field	Description
5:4 CLKS	<b>Clock Source Select</b> — These two read/write bits select one of four different clock sources as the input to the MTIM16 prescaler. Changing the clock source while the counter is active does not clear the counter. The count continues with the new clock source. Reset clears CLKS to 00. 00 Encoding 0. Bus clock (BUSCLK) 01 Encoding 1. Fixed-frequency clock (XCLK) 10 Encoding 3. External source (TCLK pin), falling edge 11 Encoding 4. External source (TCLK pin), rising edge
3:0 PS	<b>Clock Source Prescaler</b> — These four read/write bits select one of nine outputs from the 8-bit prescaler. Changing the prescaler value while the counter is active does not clear the counter. The count continues with the new prescaler value. Reset clears PS to 0000. 0000 Encoding 0. MTIM16 clock source ÷ 1 0001 Encoding 1. MTIM 16clock source ÷ 2 0010 Encoding 2. MTIM16 clock source ÷ 4 0011 Encoding 3. MTIM16 clock source ÷ 8 0100 Encoding 4. MTIM16 clock source ÷ 16 0101 Encoding 5. MTIM16 clock source ÷ 32 0110 Encoding 6. MTIM16 clock source ÷ 64 0111 Encoding 7. MTIM16 clock source ÷ 128 1000 Encoding 8. MTIM16 clock source ÷ 256 All other encodings default to MTIM16 clock source ÷ 256.

### 11.4.3 MTIM16 Counter Register High/Low (MTIMCNTH:L)

MTIMCNTH is the read-only value of the high byte of current MTIM16 16-bit counter.

**Figure 11-6. MTIM16 Counter Register High (MTIMCNTH)**
**Table 11-4. MTIMCNTH Register Field Description**

Field	Description
7:0 CNTH	<b>MTIM16 Count (High Byte)</b> — These eight read-only bits contain the current high byte value of the 16-bit counter. Writing has no effect to this register. Reset clears the register to 0x00.

MTIMCNTL is the read-only value of the low byte of current MTIM16 16-bit counter.

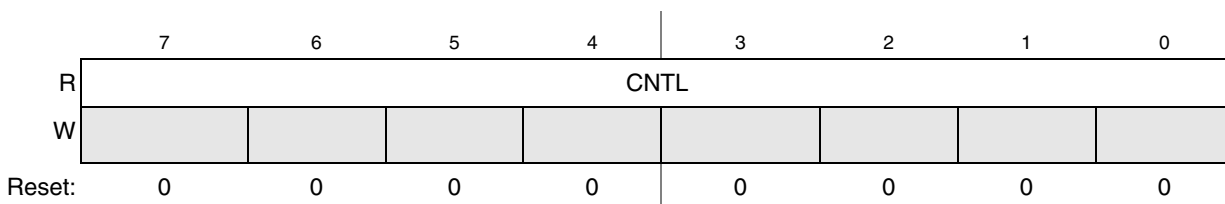

Figure 11-7. MTIM16 Counter Register Low (MTIMCNTL)

Table 11-5. MTIMCNTL Register Field Description

Field	Description
7:0 CNTL	<b>MTIM16 Count (Low Byte)</b> — These eight read-only bits contain the current low byte value of the 16-bit counter. Writing has no effect to this register. Reset clears the register to 0x00.

When either MTIMCNTH or MTIMCNTL is read, the content of the two registers is latched into a buffer where they remain latched until the other register is read. This allows the coherent 16-bit to be read in both big-endian and little-endian compile environments and ensures the 16-bit counter is unaffected by the read operation. The coherency mechanism is automatically restarted by an MCU reset or setting of TRST bit of MTIMSC register (whether BDM mode is active or not).

When BDM is active, the coherency mechanism is frozen such that the buffer latches remain in the state they were in when the BDM became active, even if one or both halves of the counter register are read while BDM is active. This assures that if the user was in the middle of reading a 16-bit register when BDM became active, the appropriate value from the other half of the 16-bit value will be read after returning to normal execution. The value read from the MTIMCNTH and MTIMCNTL registers in BDM mode is the value of these registers and not the value of their read buffer.

### 11.4.4 MTIM16 Modulo Register High/Low (MTIMMODH/MTIMMODL)

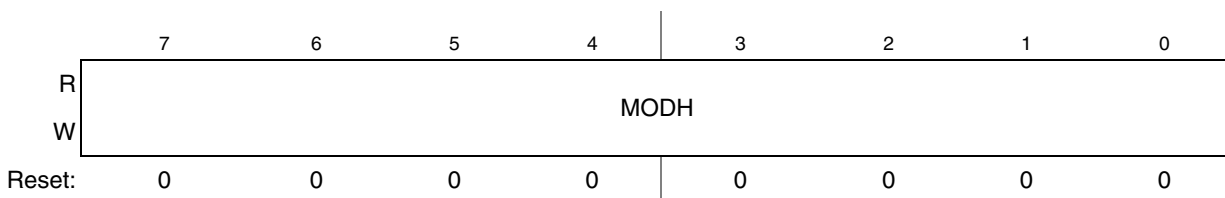
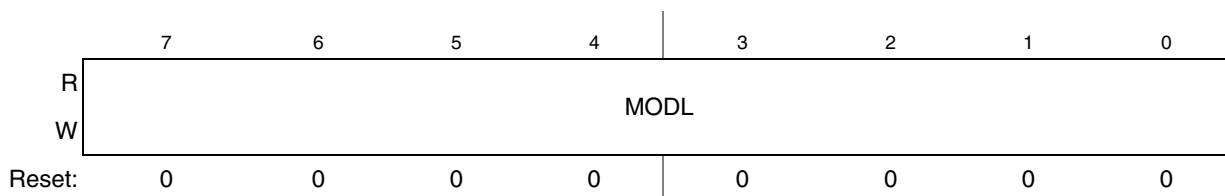

Figure 11-8. MTIM16 Modulo Register High (MTIMMODH)

Table 11-6. MTIMMODH Register Field Descriptions

Field	Description
7:0 MODH	<b>MTIM16 Modulo (High Byte)</b> — These eight read/write bits contain the modulo high byte value used to reset the counter and set TOF. Reset sets the register to 0x00.

**Figure 11-9. MTIM16 Modulo Register Low (MTIMMODL)**
**Table 11-7. MTIMMODL Register Field Descriptions**

Field	Description
7:0 MODL	<b>MTIM16 Modulo (Low Byte)</b> — These eight read/write bits contain the modulo low byte value used to reset the counter and set TOF. Reset sets the register to 0x00.

A value of 0x0000 in MTIMMODH:L puts the MTIM16 in free-running mode. Writing to either MTIMMODH or MTIMMODL latches the value into a buffer and the registers are updated with the value of their write buffer after the second byte writing, the updated MTIMMODH:L will take effect in the next MTIM16 counter cycle except for the first writing of modulo after a chip reset or in BDM mode. But after a software reset, the MTIMMODH:L takes effect at once even if it didn't take effect before the reset. On the first writing of MTIMMODH:L after chip reset, the counter is reset and the modulo takes effect immediately. The latching mechanism may be manually reset by setting the TRST bit of MTIMSC register (whether BDM is active or not).

When BDM is active, the coherency mechanism is frozen such that the buffer latches remain in the state they were in when the BDM became active, even if one or both halves of the modulo register are written while BDM is active. Any writing to the modulo registers bypasses the buffer latches and writes directly to the modulo register while BDM is active, and also the counter is cleared at the same time. The reading of MTIMMODH:L returns the modulo value which is taking effect whenever in normal run mode or in BDM mode.

## 11.5 Functional Description

The MTIM16 is composed of a main 16-bit up-counter with 16-bit modulo register, a clock source selector, and a prescaler block with nine selectable values. The module also contains software selectable interrupt logic.

The MTIM16 counter (MTIMCNTH:L) has three modes of operation: stopped, free-running, and modulo. The counter is stopped out of reset. If the counter starts without writing a new value to the modulo registers, it will be in free-running mode. The counter is in modulo mode when a value other than 0x0000 is in the modulo registers.

After an MCU reset, the counter stops and resets to 0x0000, and the modulo is also reset to 0x0000. The bus clock functions as the default clock source and the prescale value is divided by 1. To start the MTIM16 in free-running mode, write to the MTIM16 status and control register (MTIMSC) and clear the MTIM16 stop bit (TSTP).

Four clock sources are software selectable: the internal bus clock, the fixed frequency clock (XCLK), and an external clock on the TCLK pin, selectable as incrementing on either rising or falling edges. The

MTIM16 clock select bits (CLKS1:CLKS0) in MTIMSC are used to select the desired clock source. If the counter is active (TSTP = 0) when a new clock source is selected, the counter continues counting from the previous value using the new clock source.

Nine prescale values are software selectable: clock source divided by 1, 2, 4, 8, 16, 32, 64, 128, or 256. The prescaler select bits (PS[3:0]) in MTIMxSC select the desired prescale value. If the counter is active (TSTP = 0) when a new prescaler value is selected, the counter continues counting from the previous value using the new prescaler value.

The MTIM16 modulo register (MTIMMODH:L) allows the overflow compare value to be set to any value from 0x0001 to 0xFFFF. Reset clears the modulo value to 0x0000, which results in a free running counter.

When the counter is active (TSTP = 0), it increases at the selected rate until the count matches the modulo value. When these values match, the counter overflows to 0x0000 and continues counting. The MTIM16 overflow flag (TOF) is set whenever the counter overflows. The flag sets on the transition from the modulo value to 0x0000.

Clearing TOF is a two-step process. The first step is to read the MTIMxSC register while TOF is set. The second step is to write a 0 to TOF. If another overflow occurs between the first and second steps, the clearing process is reset and TOF stays set after the second step is performed. This will prevent the second occurrence from being missed. TOF is also cleared when a 1 is written to TRST.

The MTIM16 allows for an optional interrupt to be generated whenever TOF is set. To enable the MTIM16 overflow interrupt, set the MTIM16 overflow interrupt enable bit (TOIE) in MTIMSC. TOIE should never be written to a 1 while TOF = 1. Instead, TOF should be cleared first, then the TOIE can be set to 1.

### 11.5.1 MTIM16 Operation Example

This section shows an example of the MTIM16 operation as the counter reaches a matching value from the modulo register.

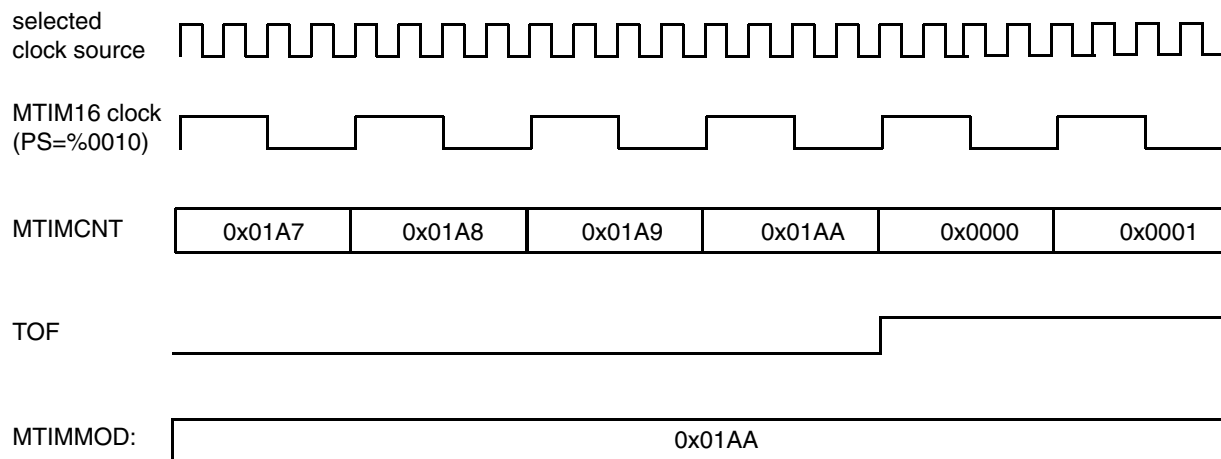

Figure 11-10. MTIM16 Counter Overflow Example

In the example of [Figure 11-10](#), the selected clock source could be any of the four possible choices. The prescaler is set to PS = %0010 or divide-by-4. The modulo value in the MTIMMODH:L register is set to

0x01AA. When the counter, MTIMCNTH:L, reaches the modulo value of 0x01AA, the counter overflows to 0x0000 and continues counting. The timer overflow flag, TOF, sets when the counter value changes from 0x01AA to 0x0000. An MTIM16 overflow interrupt is generated when TOF is set, if TOIE = 1.



# Chapter 12

## Analog-to-Digital Converter (S08ADC12V1)

### 12.1 Introduction

The 8-bit 12-ch analog-to-digital converter (ADC) is a successive approximation ADC designed for operation within an integrated microcontroller system-on-chip.

#### NOTE

The ADC in MC9S08FL16 series MCUs supports only the 8-bit conversion, ignore the 10-bit and 12-bit information in this chapter.

#### 12.1.1 ADC Channel Assignments

Figure 12-1 shows the ADC channel assignments. Reserved channels convert to an unknown value.

Table 12-1. ADC Channel Assignment

ADCH	Input Select	ADCH	Input Select
00000	AD0	10000	Reserved
00001	AD1	10001	Reserved
00010	AD2	10010	Reserved
00011	AD3	10011	Reserved
00100	AD4	10100	Reserved
00101	AD5	10101	Reserved
00110	AD6	10110	Reserved
00111	AD7	10111	Reserved
01000	AD8	11000	Reserved
01001	AD9	11001	Reserved
01010	AD10	11010	Temperature Sensor
01011	AD11	11011	Bandgap
01100	Reserved	11100	Reserved
01101	Reserved	11101	$V_{REFH}$ <sup>1</sup>
01110	Reserved	11110	$V_{REFL}$ <sup>2</sup>
01111	Reserved	11111	Module disabled

<sup>1</sup>  $V_{REFH}$ ,  $V_{DDA}$  and  $V_{DD}$  are connected together.

<sup>2</sup>  $V_{REFL}$ ,  $V_{SSA}$  and  $V_{SS}$  are connected together.

### 12.1.2 Alternate Clock

The ADC is capable of performing conversions using the MCU bus clock, the bus clock divided by two, the local asynchronous clock (ADACK) within the module, or the alternate clock (ALTCLK). The ALTCLK on the MC9S08FL16 series are connected to the OSCOUT.

### 12.1.3 Hardware Trigger

In MC9S08FL16 series MCUs, the ADC hardware trigger is associated with TCLK. The TCLKPEN bit in SOPT1 register must be enabled to use TCLK as hardware trigger.



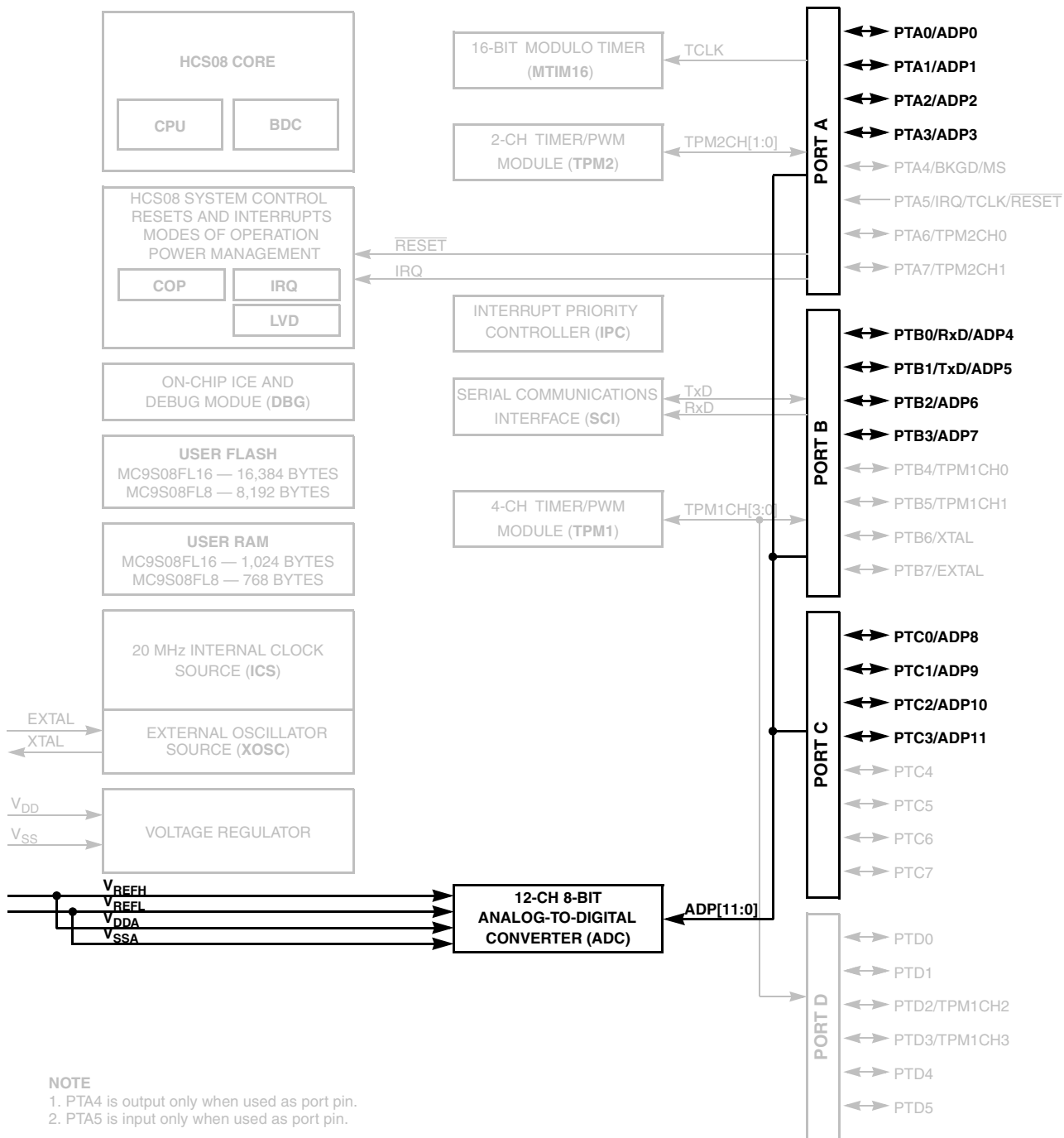

Figure 12-1. MC9S08FL16 Series Block Diagram Highlighting ADC Module and Pins.

## 12.1.4 Features

Features of the ADC module include:

- Linear successive approximation algorithm with 12-bit resolution
- Up to 28 analog inputs
- Output formatted in 12-, 10-, or 8-bit right-justified unsigned format
- Single or continuous conversion (automatic return to idle after single conversion)
- Configurable sample time and conversion speed/power
- Conversion complete flag and interrupt
- Input clock selectable from up to four sources
- Operation in wait or stop3 modes for lower noise operation
- Asynchronous clock source for lower noise operation
- Selectable asynchronous hardware conversion trigger
- Automatic compare with interrupt for less-than, or greater-than or equal-to, programmable value
- Temperature sensor

## 12.1.5 ADC Module Block Diagram

Figure 12-2 provides a block diagram of the ADC module.

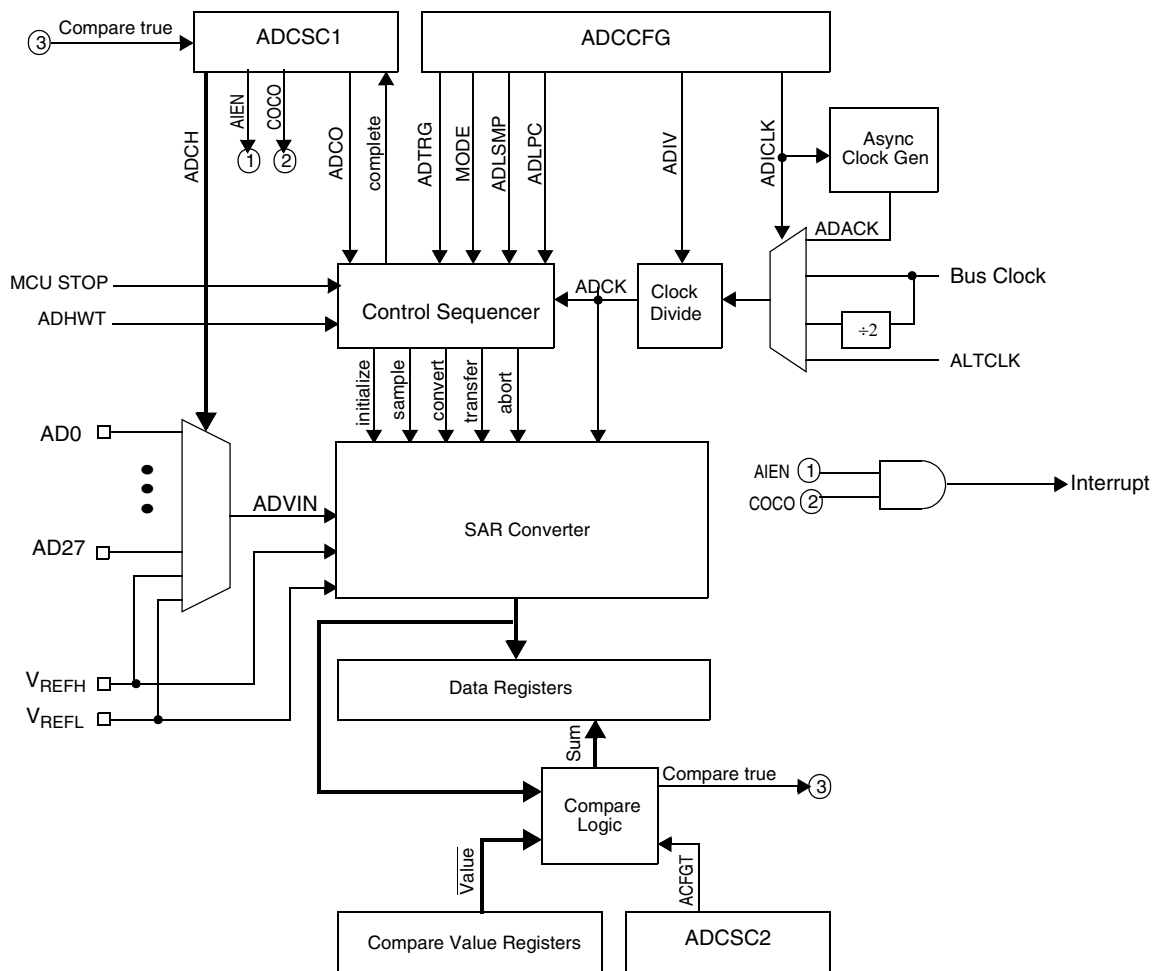

Figure 12-2. ADC Block Diagram

## 12.2 External Signal Description

The ADC module supports up to 28 separate analog inputs. It also requires four supply/reference/ground connections.

Table 12-2. Signal Properties

Name	Function
AD27–AD0	Analog Channel inputs
V <sub>REFH</sub>	High reference voltage
V <sub>REFL</sub>	Low reference voltage
V <sub>DDA</sub>	Analog power supply
V <sub>SSA</sub>	Analog ground

### 12.2.1 Analog Power ( $V_{DDA}$ )

The ADC analog portion uses  $V_{DDA}$  as its power connection. In some packages,  $V_{DDA}$  is connected internally to  $V_{DD}$ . If externally available, connect the  $V_{DDA}$  pin to the same voltage potential as  $V_{DD}$ . External filtering may be necessary to ensure clean  $V_{DDA}$  for good results.

### 12.2.2 Analog Ground ( $V_{SSA}$ )

The ADC analog portion uses  $V_{SSA}$  as its ground connection. In some packages,  $V_{SSA}$  is connected internally to  $V_{SS}$ . If externally available, connect the  $V_{SSA}$  pin to the same voltage potential as  $V_{SS}$ .

### 12.2.3 Voltage Reference High ( $V_{REFH}$ )

$V_{REFH}$  is the high reference voltage for the converter. In some packages,  $V_{REFH}$  is connected internally to  $V_{DDA}$ . If externally available,  $V_{REFH}$  may be connected to the same potential as  $V_{DDA}$  or may be driven by an external source between the minimum  $V_{DDA}$  spec and the  $V_{DDA}$  potential ( $V_{REFH}$  must never exceed  $V_{DDA}$ ).

### 12.2.4 Voltage Reference Low ( $V_{REFL}$ )

$V_{REFL}$  is the low-reference voltage for the converter. In some packages,  $V_{REFL}$  is connected internally to  $V_{SSA}$ . If externally available, connect the  $V_{REFL}$  pin to the same voltage potential as  $V_{SSA}$ .

### 12.2.5 Analog Channel Inputs (ADx)

The ADC module supports up to 28 separate analog inputs. An input is selected for conversion through the ADCH channel select bits.

## 12.3 Register Definition

These memory-mapped registers control and monitor operation of the ADC:

- Status and control register, ADCSC1
- Status and control register, ADCSC2
- Data result registers, ADCRH and ADCRL
- Compare value registers, ADCCVH and ADCCVL
- Configuration register, ADCCFG
- Pin control registers, APCTL1, APCTL2, APCTL3

### 12.3.1 Status and Control Register 1 (ADCSC1)

This section describes the function of the ADC status and control register (ADCSC1). Writing ADCSC1 aborts the current conversion and initiates a new conversion (if the ADCH bits are equal to a value other than all 1s).

**Figure 12-3. Status and Control Register (ADCSC1)**
**Table 12-3. ADCSC1 Field Descriptions**

Field	Description
7 COCO	Conversion Complete Flag. The COCO flag is a read-only bit set each time a conversion is completed when the compare function is disabled (ACFE = 0). When the compare function is enabled (ACFE = 1), the COCO flag is set upon completion of a conversion only if the compare result is true. This bit is cleared when ADCSC1 is written or when ADCRL is read. 0 Conversion not completed 1 Conversion completed
6 AIEN	Interrupt Enable AIEN enables conversion complete interrupts. When COCO becomes set while AIEN is high, an interrupt is asserted. 0 Conversion complete interrupt disabled 1 Conversion complete interrupt enabled
5 ADCO	Continuous Conversion Enable. ADCO enables continuous conversions. 0 One conversion following a write to the ADCSC1 when software triggered operation is selected, or one conversion following assertion of ADHWT when hardware triggered operation is selected. 1 Continuous conversions initiated following a write to ADCSC1 when software triggered operation is selected. Continuous conversions are initiated by an ADHWT event when hardware triggered operation is selected.
4:0 ADCH	Input Channel Select. The ADCH bits form a 5-bit field that selects one of the input channels. The input channels are detailed in <a href="#">Table 12-4</a> . The successive approximation converter subsystem is turned off when the channel select bits are all set. This feature allows for explicit disabling of the ADC and isolation of the input channel from all sources. Terminating continuous conversions this way prevents an additional, single conversion from being performed. It is not necessary to set the channel select bits to all ones to place the ADC in a low-power state when continuous conversions are not enabled because the module automatically enters a low-power state when a conversion completes.

**Table 12-4. Input Channel Select**

ADCH	Input Select
00000–01111	AD0–15
10000–11011	AD16–27
11100	Reserved
11101	V <sub>REFH</sub>
11110	V <sub>REFL</sub>
11111	Module disabled

### 12.3.2 Status and Control Register 2 (ADCSC2)

The ADCSC2 register controls the compare function, conversion trigger, and conversion active of the ADC module.

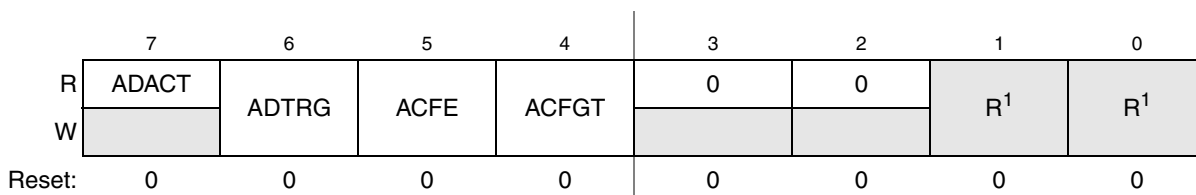

**Figure 12-4. Status and Control Register 2 (ADCSC2)**

<sup>1</sup> Bits 1 and 0 are reserved bits that must always be written to 0.

**Table 12-5. ADCSC2 Register Field Descriptions**

Field	Description
7 ADACT	Conversion Active. Indicates that a conversion is in progress. ADACT is set when a conversion is initiated and cleared when a conversion is completed or aborted. 0 Conversion not in progress 1 Conversion in progress
6 ADTRG	Conversion Trigger Select. Selects the type of trigger used for initiating a conversion. Two types of triggers are selectable: software trigger and hardware trigger. When software trigger is selected, a conversion is initiated following a write to ADCSC1. When hardware trigger is selected, a conversion is initiated following the assertion of the ADHWT input. 0 Software trigger selected 1 Hardware trigger selected
5 ACFE	Compare Function Enable. Enables the compare function. 0 Compare function disabled 1 Compare function enabled
4 ACFGT	Compare Function Greater Than Enable. Configures the compare function to trigger when the result of the conversion of the input being monitored is greater than or equal to the compare value. The compare function defaults to triggering when the result of the compare of the input being monitored is less than the compare value. 0 Compare triggers when input is less than compare value 1 Compare triggers when input is greater than or equal to compare value

### 12.3.3 Data Result High Register (ADCRH)

In 12-bit operation, ADCRH contains the upper four bits of 12-bit conversion data. In 10-bit operation, ADCRH contains the upper two bits of 10-bit conversion data. In 12-bit and 10-bit mode, ADCRH is updated each time a conversion completes except when automatic compare is enabled and the compare condition is not met. When configured for 10-bit mode, ADR[11:10] are cleared. When configured for 8-bit mode, ADR[11:8] are cleared.

When automatic compare is not enabled, the value stored in ADCRH are the upper bits of the conversion result. When automatic compare is enabled, the conversion result is manipulated as described in [Section 12.4.5, “Automatic Compare Function”](#) prior to storage in ADCRH:ADCRL registers.

In 12-bit and 10-bit mode, reading ADCRH prevents the ADC from transferring subsequent conversion data into the result registers until ADCRL is read. If ADCRL is not read until after the next conversion is completed, the intermediate conversion data is lost. In 8-bit mode, there is no interlocking with ADCRL. If the MODE bits are changed, any data in ADCRH becomes invalid.

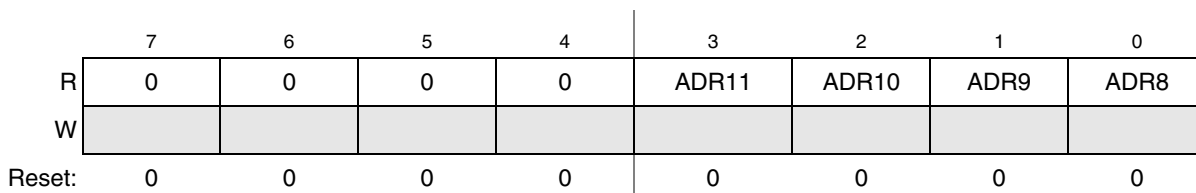

Figure 12-5. Data Result High Register (ADCRH)

### 12.3.4 Data Result Low Register (ADCRL)

ADCRL contains the lower eight bits of a 12-bit or 10-bit conversion data, and all eight bits of 8-bit conversion data. ADCRL is updated each time a conversion completes except when automatic compare is enabled and the compare condition is not met.

When automatic compare is not enabled, the value stored in ADCRL is the lower eight bits of the conversion result. When automatic compare is enabled, the conversion result is manipulated as described in [Section 12.4.5, “Automatic Compare Function”](#) prior to storage in ADCRH:ADCRL registers.

In 12-bit and 10-bit mode, reading ADCRH prevents the ADC from transferring subsequent conversion data into the result registers until ADCRL is read. If ADCRL is not read until the after next conversion is completed, the intermediate conversion data is lost. In 8-bit mode, there is no interlocking with ADCRH. If the MODE bits are changed, any data in ADCRL becomes invalid.

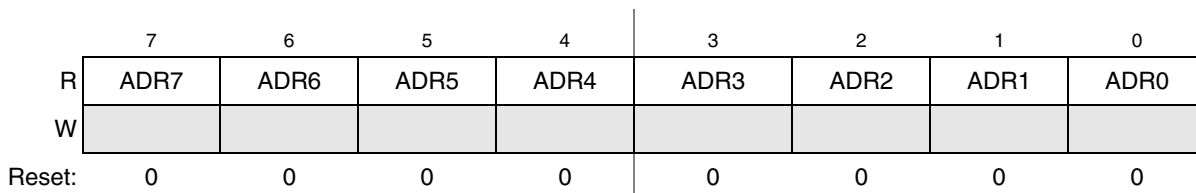

Figure 12-6. Data Result Low Register (ADCRL)

### 12.3.5 Compare Value High Register (ADCCVH)

In 12-bit mode, the ADCCVH register holds the upper four bits of the 12-bit compare value. When the compare function is enabled, these bits are compared to the upper four bits of the result following a conversion in 12-bit mode.

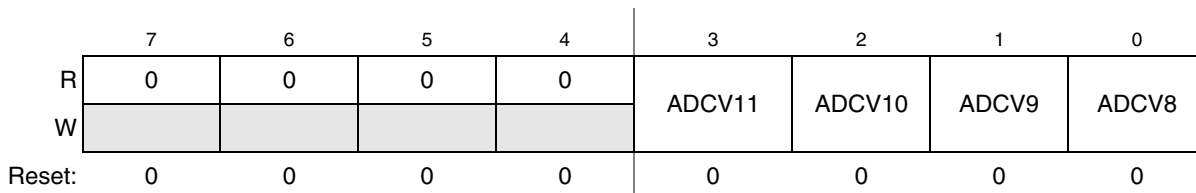

Figure 12-7. Compare Value High Register (ADCCVH)

In 10-bit mode, the ADCCVH register holds the upper two bits of the 10-bit compare value (ADCV[9:8]). These bits are compared to the upper two bits of the result following a conversion in 10-bit mode when the compare function is enabled.

In 8-bit mode, ADCCVH is not used during compare.

### 12.3.6 Compare Value Low Register (ADCCVL)

This register holds the lower eight bits of the 12-bit or 10-bit compare value or all eight bits of the 8-bit compare value. When the compare function is enabled, bits ADCV[7:0] are compared to the lower eight bits of the result following a conversion in 12-bit, 10-bit or 8-bit mode.

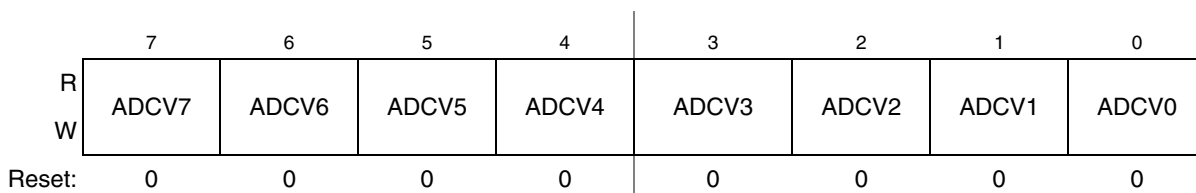

Figure 12-8. Compare Value Low Register (ADCCVL)

### 12.3.7 Configuration Register (ADCCFG)

ADCCFG selects the mode of operation, clock source, clock divide, and configures for low power and long sample time.

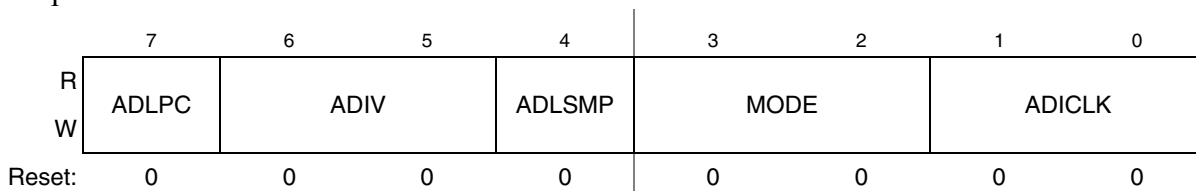

Figure 12-9. Configuration Register (ADCCFG)



**Table 12-6. ADCCFG Register Field Descriptions**

Field	Description
7 ADLPC	Low-Power Configuration. ADLPC controls the speed and power configuration of the successive approximation converter. This optimizes power consumption when higher sample rates are not required. 0 High speed configuration 1 Low power configuration: The power is reduced at the expense of maximum clock speed.
6:5 ADIV	Clock Divide Select. ADIV selects the divide ratio used by the ADC to generate the internal clock ADCK. <a href="#">Table 12-7</a> shows the available clock configurations.
4 ADLSMP	Long Sample Time Configuration. ADLSMP selects between long and short sample time. This adjusts the sample period to allow higher impedance inputs to be accurately sampled or to maximize conversion speed for lower impedance inputs. Longer sample times can also be used to lower overall power consumption when continuous conversions are enabled if high conversion rates are not required. 0 Short sample time 1 Long sample time
3:2 MODE	Conversion Mode Selection. MODE bits are used to select between 12-, 10-, or 8-bit operation. See <a href="#">Table 12-8</a> .
1:0 ADICLK	Input Clock Select. ADICLK bits select the input clock source to generate the internal clock ADCK. See <a href="#">Table 12-9</a> .

**Table 12-7. Clock Divide Select**

ADIV	Divide Ratio	Clock Rate
00	1	Input clock
01	2	Input clock ÷ 2
10	4	Input clock ÷ 4
11	8	Input clock ÷ 8

**Table 12-8. Conversion Modes**

MODE	Mode Description
00	8-bit conversion (N=8)
01	12-bit conversion (N=12)
10	10-bit conversion (N=10)
11	Reserved

**Table 12-9. Input Clock Select**

ADICLK	Selected Clock Source
00	Bus clock
01	Bus clock divided by 2
10	Alternate clock (ALTCLK)
11	Asynchronous clock (ADACK)

### 12.3.8 Pin Control 1 Register (APCTL1)

The pin control registers disable the I/O port control of MCU pins used as analog inputs. APCTL1 is used to control the pins associated with channels 0–7 of the ADC module.

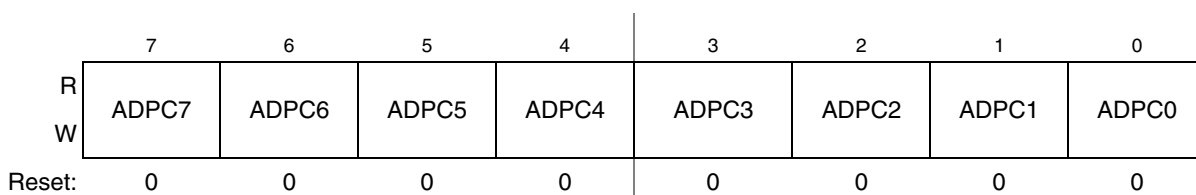

**Figure 12-10. Pin Control 1 Register (APCTL1)**

**Table 12-10. APCTL1 Register Field Descriptions**

Field	Description
7 ADPC7	ADC Pin Control 7. ADPC7 controls the pin associated with channel AD7. 0 AD7 pin I/O control enabled 1 AD7 pin I/O control disabled
6 ADPC6	ADC Pin Control 6. ADPC6 controls the pin associated with channel AD6. 0 AD6 pin I/O control enabled 1 AD6 pin I/O control disabled
5 ADPC5	ADC Pin Control 5. ADPC5 controls the pin associated with channel AD5. 0 AD5 pin I/O control enabled 1 AD5 pin I/O control disabled
4 ADPC4	ADC Pin Control 4. ADPC4 controls the pin associated with channel AD4. 0 AD4 pin I/O control enabled 1 AD4 pin I/O control disabled
3 ADPC3	ADC Pin Control 3. ADPC3 controls the pin associated with channel AD3. 0 AD3 pin I/O control enabled 1 AD3 pin I/O control disabled
2 ADPC2	ADC Pin Control 2. ADPC2 controls the pin associated with channel AD2. 0 AD2 pin I/O control enabled 1 AD2 pin I/O control disabled

**Table 12-10. APCTL1 Register Field Descriptions (continued)**

Field	Description
1 ADPC1	ADC Pin Control 1. ADPC1 controls the pin associated with channel AD1. 0 AD1 pin I/O control enabled 1 AD1 pin I/O control disabled
0 ADPC0	ADC Pin Control 0. ADPC0 controls the pin associated with channel AD0. 0 AD0 pin I/O control enabled 1 AD0 pin I/O control disabled

### 12.3.9 Pin Control 2 Register (APCTL2)

APCTL2 controls channels 8–15 of the ADC module.

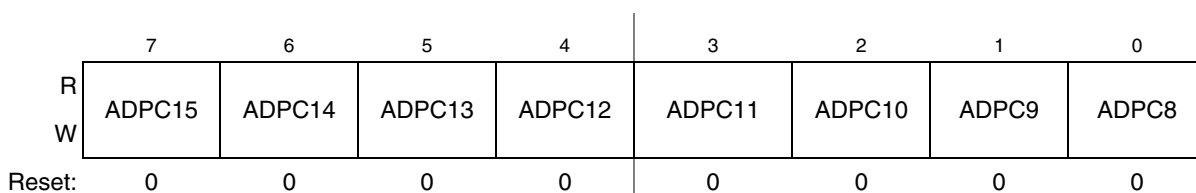
**Figure 12-11. Pin Control 2 Register (APCTL2)**
**Table 12-11. APCTL2 Register Field Descriptions**

Field	Description
7 ADPC15	ADC Pin Control 15. ADPC15 controls the pin associated with channel AD15. 0 AD15 pin I/O control enabled 1 AD15 pin I/O control disabled
6 ADPC14	ADC Pin Control 14. ADPC14 controls the pin associated with channel AD14. 0 AD14 pin I/O control enabled 1 AD14 pin I/O control disabled
5 ADPC13	ADC Pin Control 13. ADPC13 controls the pin associated with channel AD13. 0 AD13 pin I/O control enabled 1 AD13 pin I/O control disabled
4 ADPC12	ADC Pin Control 12. ADPC12 controls the pin associated with channel AD12. 0 AD12 pin I/O control enabled 1 AD12 pin I/O control disabled
3 ADPC11	ADC Pin Control 11. ADPC11 controls the pin associated with channel AD11. 0 AD11 pin I/O control enabled 1 AD11 pin I/O control disabled
2 ADPC10	ADC Pin Control 10. ADPC10 controls the pin associated with channel AD10. 0 AD10 pin I/O control enabled 1 AD10 pin I/O control disabled

**Table 12-11. APCTL2 Register Field Descriptions (continued)**

Field	Description
1 ADPC9	ADC Pin Control 9. ADPC9 controls the pin associated with channel AD9. 0 AD9 pin I/O control enabled 1 AD9 pin I/O control disabled
0 ADPC8	ADC Pin Control 8. ADPC8 controls the pin associated with channel AD8. 0 AD8 pin I/O control enabled 1 AD8 pin I/O control disabled

### 12.3.10 Pin Control 3 Register (APCTL3)

APCTL3 controls channels 16–23 of the ADC module.

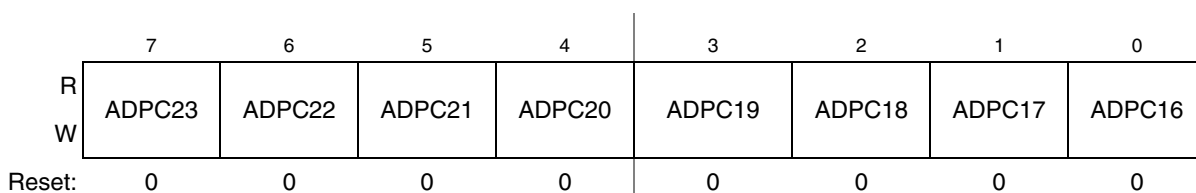

**Figure 12-12. Pin Control 3 Register (APCTL3)**

**Table 12-12. APCTL3 Register Field Descriptions**

Field	Description
7 ADPC23	ADC Pin Control 23. ADPC23 controls the pin associated with channel AD23. 0 AD23 pin I/O control enabled 1 AD23 pin I/O control disabled
6 ADPC22	ADC Pin Control 22. ADPC22 controls the pin associated with channel AD22. 0 AD22 pin I/O control enabled 1 AD22 pin I/O control disabled
5 ADPC21	ADC Pin Control 21. ADPC21 controls the pin associated with channel AD21. 0 AD21 pin I/O control enabled 1 AD21 pin I/O control disabled
4 ADPC20	ADC Pin Control 20. ADPC20 controls the pin associated with channel AD20. 0 AD20 pin I/O control enabled 1 AD20 pin I/O control disabled
3 ADPC19	ADC Pin Control 19. ADPC19 controls the pin associated with channel AD19. 0 AD19 pin I/O control enabled 1 AD19 pin I/O control disabled
2 ADPC18	ADC Pin Control 18. ADPC18 controls the pin associated with channel AD18. 0 AD18 pin I/O control enabled 1 AD18 pin I/O control disabled

**Table 12-12. APCTL3 Register Field Descriptions (continued)**

Field	Description
1 ADPC17	ADC Pin Control 17. ADPC17 controls the pin associated with channel AD17. 0 AD17 pin I/O control enabled 1 AD17 pin I/O control disabled
0 ADPC16	ADC Pin Control 16. ADPC16 controls the pin associated with channel AD16. 0 AD16 pin I/O control enabled 1 AD16 pin I/O control disabled

## 12.4 Functional Description

The ADC module is disabled during reset or when the ADCH bits are all high. The module is idle when a conversion has completed and another conversion has not been initiated. When idle, the module is in its lowest power state.

The ADC can perform an analog-to-digital conversion on any of the software selectable channels. In 12-bit and 10-bit mode, the selected channel voltage is converted by a successive approximation algorithm into a 12-bit digital result. In 8-bit mode, the selected channel voltage is converted by a successive approximation algorithm into a 9-bit digital result.

When the conversion is completed, the result is placed in the data registers (ADCRH and ADCRL). In 10-bit mode, the result is rounded to 10 bits and placed in the data registers (ADCRH and ADCRL). In 8-bit mode, the result is rounded to 8 bits and placed in ADCRL. The conversion complete flag (COCO) is then set and an interrupt is generated if the conversion complete interrupt has been enabled (AIEN = 1).

The ADC module has the capability of automatically comparing the result of a conversion with the contents of its compare registers. The compare function is enabled by setting the ACFE bit and operates with any of the conversion modes and configurations.

### 12.4.1 Clock Select and Divide Control

One of four clock sources can be selected as the clock source for the ADC module. This clock source is then divided by a configurable value to generate the input clock to the converter (ADCK). The clock is selected from one of the following sources by means of the ADICLK bits.

- The bus clock, which is equal to the frequency at which software is executed. This is the default selection following reset.
- The bus clock divided by two. For higher bus clock rates, this allows a maximum divide by 16 of the bus clock.
- ALTCLK, as defined for this MCU (See module section introduction).
- The asynchronous clock (ADACK). This clock is generated from a clock source within the ADC module. When selected as the clock source, this clock remains active while the MCU is in wait or stop3 mode and allows conversions in these modes for lower noise operation.

Whichever clock is selected, its frequency must fall within the specified frequency range for ADCK. If the available clocks are too slow, the ADC do not perform according to specifications. If the available clocks

are too fast, the clock must be divided to the appropriate frequency. This divider is specified by the ADIV bits and can be divide-by 1, 2, 4, or 8.

## 12.4.2 Input Select and Pin Control

The pin control registers (APCTL3, APCTL2, and APCTL1) disable the I/O port control of the pins used as analog inputs. When a pin control register bit is set, the following conditions are forced for the associated MCU pin:

- The output buffer is forced to its high impedance state.
- The input buffer is disabled. A read of the I/O port returns a zero for any pin with its input buffer disabled.
- The pullup is disabled.

## 12.4.3 Hardware Trigger

The ADC module has a selectable asynchronous hardware conversion trigger, ADHWT, that is enabled when the ADTRG bit is set. This source is not available on all MCUs. Consult the module introduction for information on the ADHWT source specific to this MCU.

When ADHWT source is available and hardware trigger is enabled (ADTRG=1), a conversion is initiated on the rising edge of ADHWT. If a conversion is in progress when a rising edge occurs, the rising edge is ignored. In continuous convert configuration, only the initial rising edge to launch continuous conversions is observed. The hardware trigger function operates in conjunction with any of the conversion modes and configurations.

## 12.4.4 Conversion Control

Conversions can be performed in 12-bit mode, 10-bit mode, or 8-bit mode as determined by the MODE bits. Conversions can be initiated by a software or hardware trigger. In addition, the ADC module can be configured for low power operation, long sample time, continuous conversion, and automatic compare of the conversion result to a software determined compare value.

### 12.4.4.1 Initiating Conversions

A conversion is initiated:

- Following a write to ADCSC1 (with ADCH bits not all 1s) if software triggered operation is selected.
- Following a hardware trigger (ADHWT) event if hardware triggered operation is selected.
- Following the transfer of the result to the data registers when continuous conversion is enabled.

If continuous conversions are enabled, a new conversion is automatically initiated after the completion of the current conversion. In software triggered operation, continuous conversions begin after ADCSC1 is written and continue until aborted. In hardware triggered operation, continuous conversions begin after a hardware trigger event and continue until aborted.

### 12.4.4.2 Completing Conversions

A conversion is completed when the result of the conversion is transferred into the data result registers, ADCRH and ADCRL. This is indicated by the setting of COCO. An interrupt is generated if AIEN is high at the time that COCO is set.

A blocking mechanism prevents a new result from overwriting previous data in ADCRH and ADCRL if the previous data is in the process of being read while in 12-bit or 10-bit MODE (the ADCRH register has been read but the ADCRL register has not). When blocking is active, the data transfer is blocked, COCO is not set, and the new result is lost. In the case of single conversions with the compare function enabled and the compare condition false, blocking has no effect and ADC operation is terminated. In all other cases of operation, when a data transfer is blocked, another conversion is initiated regardless of the state of ADCO (single or continuous conversions enabled).

If single conversions are enabled, the blocking mechanism could result in several discarded conversions and excess power consumption. To avoid this issue, the data registers must not be read after initiating a single conversion until the conversion completes.

### 12.4.4.3 Aborting Conversions

Any conversion in progress is aborted when:

- A write to ADCSC1 occurs (the current conversion will be aborted and a new conversion will be initiated, if ADCH are not all 1s).
- A write to ADCSC2, ADCCFG, ADCCVH, or ADCCVL occurs. This indicates a mode of operation change has occurred and the current conversion is therefore invalid.
- The MCU is reset.
- The MCU enters stop mode with ADACK not enabled.

When a conversion is aborted, the contents of the data registers, ADCRH and ADCRL, are not altered. However, they continue to be the values transferred after the completion of the last successful conversion. If the conversion was aborted by a reset, ADCRH and ADCRL return to their reset states.

### 12.4.4.4 Power Control

The ADC module remains in its idle state until a conversion is initiated. If ADACK is selected as the conversion clock source, the ADACK clock generator is also enabled.

Power consumption when active can be reduced by setting ADLPC. This results in a lower maximum value for  $f_{ADCK}$  (see the electrical specifications).

### 12.4.4.5 Sample Time and Total Conversion Time

The total conversion time depends on the sample time (as determined by ADLSMP), the MCU bus frequency, the conversion mode (8-bit, 10-bit or 12-bit), and the frequency of the conversion clock ( $f_{ADCK}$ ). After the module becomes active, sampling of the input begins. ADLSMP selects between short (3.5 ADCK cycles) and long (23.5 ADCK cycles) sample times. When sampling is complete, the converter is isolated from the input channel and a successive approximation algorithm is performed to determine the

digital value of the analog signal. The result of the conversion is transferred to ADCRH and ADCRL upon completion of the conversion algorithm.

If the bus frequency is less than the  $f_{ADCK}$  frequency, precise sample time for continuous conversions cannot be guaranteed when short sample is enabled (ADLSMP=0). If the bus frequency is less than 1/11th of the  $f_{ADCK}$  frequency, precise sample time for continuous conversions cannot be guaranteed when long sample is enabled (ADLSMP=1).

The maximum total conversion time for different conditions is summarized in [Table 12-13](#).

**Table 12-13. Total Conversion Time vs. Control Conditions**

Conversion Type	ADICLK	ADLSMP	Max Total Conversion Time
Single or first continuous 8-bit	0x, 10	0	20 ADCK cycles + 5 bus clock cycles
Single or first continuous 10-bit or 12-bit	0x, 10	0	23 ADCK cycles + 5 bus clock cycles
Single or first continuous 8-bit	0x, 10	1	40 ADCK cycles + 5 bus clock cycles
Single or first continuous 10-bit or 12-bit	0x, 10	1	43 ADCK cycles + 5 bus clock cycles
Single or first continuous 8-bit	11	0	5 $\mu$ s + 20 ADCK + 5 bus clock cycles
Single or first continuous 10-bit or 12-bit	11	0	5 $\mu$ s + 23 ADCK + 5 bus clock cycles
Single or first continuous 8-bit	11	1	5 $\mu$ s + 40 ADCK + 5 bus clock cycles
Single or first continuous 10-bit or 12-bit	11	1	5 $\mu$ s + 43 ADCK + 5 bus clock cycles
Subsequent continuous 8-bit; $f_{BUS} \geq f_{ADCK}$	xx	0	17 ADCK cycles
Subsequent continuous 10-bit or 12-bit; $f_{BUS} \geq f_{ADCK}$	xx	0	20 ADCK cycles
Subsequent continuous 8-bit; $f_{BUS} \geq f_{ADCK}/11$	xx	1	37 ADCK cycles
Subsequent continuous 10-bit or 12-bit; $f_{BUS} \geq f_{ADCK}/11$	xx	1	40 ADCK cycles

The maximum total conversion time is determined by the clock source chosen and the divide ratio selected. The clock source is selectable by the ADICLK bits, and the divide ratio is specified by the ADIV bits. For example, in 10-bit mode, with the bus clock selected as the input clock source, the input clock divide-by-1 ratio selected, and a bus frequency of 8 MHz, then the conversion time for a single conversion is:

$$\text{Conversion time} = \frac{23 \text{ ADCK Cyc}}{8 \text{ MHz}/1} + \frac{5 \text{ bus Cyc}}{8 \text{ MHz}} = 3.5 \mu\text{s}$$

$$\text{Number of bus cycles} = 3.5 \mu\text{s} \times 8 \text{ MHz} = 28 \text{ cycles}$$

**NOTE**

The ADCK frequency must be between  $f_{ADCK}$  minimum and  $f_{ADCK}$  maximum to meet ADC specifications.



## 12.4.5 Automatic Compare Function

The compare function is enabled by the ACFE bit. The compare function can be configured to check for an upper or lower limit. After the input is sampled and converted, the compare value (ADCCVH and ADCCVL) is subtracted from the conversion result. When comparing to an upper limit (ACFGT = 1), if the conversion result is greater-than or equal-to the compare value, COCO is set. When comparing to a lower limit (ACFGT = 0), if the result is less than the compare value, COCO is set. An ADC interrupt is generated upon the setting of COCO if the ADC interrupt is enabled (AIEN = 1).

The subtract operation of two positive values (the conversion result less the compare value) results in a signed value that is 1-bit wider than the bit-width of the two terms. The final value transferred to the ADCRH and ADCRL registers is the result of the subtraction operation, excluding the sign bit. The value of the sign bit can be derived based on ACFGT control setting. When ACFGT=1, the sign bit of any value stored in ADCRH and ADCRL is always 0, indicating a positive result for the subtract operation. When ACFGT = 1, the sign bit of any result is always 1, indicating a negative result for the subtract operation.

Upon completion of a conversion while the compare function is enabled, if the compare condition is not true, COCO is not set and no data is transferred to the result registers.

### NOTE

The compare function can monitor the voltage on a channel while the MCU is in wait or stop3 mode. The ADC interrupt wakes the MCU when the compare condition is met.

An example of compare operation eases understanding of the compare feature. If the ADC is configured for 10-bit operation, ACFGT=0, and ADCCVH:ADCCVL= 0x200, then a conversion result of 0x080 causes the compare condition to be met and the COCO bit is set. A value of 0x280 is stored in ADCRH:ADCRL. This is signed data without the sign bit and must be combined with a derived sign bit to have meaning. The value stored in ADCRH:ADCRL is calculated as follows.

The value to interpret from the data is (Result – Compare Value) = (0x080 – 0x200) = –0x180. A standard method for handling subtraction is to convert the second term to its 2’s complement, and then add the two terms. First calculate the 2’s complement of 0x200 by complementing each bit and adding 1. Note that prior to complementing, a sign bit of 0 is added so that the 10-bit compare value becomes a 11-bit signed value that is always positive.

$$\begin{array}{r}
 \%101\ 1111\ 1111 \quad \leftarrow 1\text{'s complement of } 0x200 \text{ compare value} \\
 + \qquad \qquad \qquad \%1 \\
 \hline
 \%110\ 0000\ 0000 \quad \leftarrow 2\text{'s complement of } 0x200 \text{ compare value}
 \end{array}$$

Then the conversion result of 0x080 is added to 2’s complement of 0x200:

$$\begin{array}{r}
 \%000\ 1000\ 0000 \\
 + \ \%110\ 0000\ 0000 \\
 \hline
 \%110\ 1000\ 0000 \quad \leftarrow \text{Subtraction result is } -0x180 \text{ in signed 11-bit data}
 \end{array}$$

The subtraction result is an 11-bit signed value. The lower 10 bits (0x280) are stored in ADCRH:ADCRL. The sign bit is known to be 1 (negative) because the ACFG<sub>T</sub>=0, the COCO bit was set, and conversion data was updated in ADCRH:ADCRL.

A simpler way to use the data stored in ADCRH:ADCRL is to apply the following rules. When comparing for upper limit (ACFG<sub>T</sub>=1), the value in ADCRH:ADCRL is a positive value and does not need to be manipulated. This value is the difference between the conversion result and the compare value. When comparing for lower limit (ACFG<sub>T</sub>=0), ADCRH:ADCRL is a negative value without the sign bit. If the value from these registers is complemented and then a value of 1 is added, then the calculated value is the unsigned (i.e., absolute) difference between the conversion result and the compare value. In the previous example, 0x280 is stored in ADCRH:ADCRL. The following example shows how the absolute value of the difference is calculated.

```

%01 0111 1111 <= Complement of 10-bit value stored in ADCRH:ADCRL
+           %1
-----
%01 1000 0000 <= Unsigned value 0x180 is the absolute value of (Result - Compare Value)

```

## 12.4.6 MCU Wait Mode Operation

Wait mode is a lower power-consumption standby mode from which recovery is fast because the clock sources remain active. If a conversion is in progress when the MCU enters wait mode, it continues until completion. Conversions can be initiated while the MCU is in wait mode by means of the hardware trigger or if continuous conversions are enabled.

The bus clock, bus clock divided by two, and ADACK are available as conversion clock sources while in wait mode. The use of ALTCLK as the conversion clock source in wait is dependent on the definition of ALTCLK for this MCU. Consult the module introduction for information on ALTCLK specific to this MCU.

A conversion complete event sets the COCO and generates an ADC interrupt to wake the MCU from wait mode if the ADC interrupt is enabled (AIEN = 1).

## 12.4.7 MCU Stop3 Mode Operation

Stop mode is a low power-consumption standby mode during which most or all clock sources on the MCU are disabled.

### 12.4.7.1 Stop3 Mode With ADACK Disabled

If the asynchronous clock, ADACK, is not selected as the conversion clock, executing a stop instruction aborts the current conversion and places the ADC in its idle state. The contents of ADCRH and ADCRL are unaffected by stop3 mode. After exiting from stop3 mode, a software or hardware trigger is required to resume conversions.

### 12.4.7.2 Stop3 Mode With ADACK Enabled

If ADACK is selected as the conversion clock, the ADC continues operation during stop3 mode. For guaranteed ADC operation, the MCU's voltage regulator must remain active during stop3 mode. Consult the module introduction for configuration information for this MCU.

If a conversion is in progress when the MCU enters stop3 mode, it continues until completion. Conversions can be initiated while the MCU is in stop3 mode by means of the hardware trigger or if continuous conversions are enabled.

A conversion complete event sets the COCO and generates an ADC interrupt to wake the MCU from stop3 mode if the ADC interrupt is enabled (AIEN = 1).

#### NOTE

The ADC module can wake the system from low-power stop and cause the MCU to begin consuming run-level currents without generating a system level interrupt. To prevent this scenario, software should ensure the data transfer blocking mechanism (discussed in [Section 12.4.4.2, "Completing Conversions"](#)) is cleared when entering stop3 and continuing ADC conversions.

### 12.4.8 MCU Stop2 Mode Operation

The ADC module is automatically disabled when the MCU enters stop2 mode. All module registers contain their reset values following exit from stop2. Therefore, the module must be re-enabled and re-configured following exit from stop2.

## 12.5 Initialization Information

This section gives an example that provides some basic direction on how to initialize and configure the ADC module. You can configure the module for 8-, 10-, or 12-bit resolution, single or continuous conversion, and a polled or interrupt approach, among many other options. Refer to [Table 12-7](#), [Table 12-8](#), and [Table 12-9](#) for information used in this example.

#### NOTE

Hexadecimal values designated by a preceding 0x, binary values designated by a preceding %, and decimal values have no preceding character.

### 12.5.1 ADC Module Initialization Example

#### 12.5.1.1 Initialization Sequence

Before the ADC module can be used to complete conversions, an initialization procedure must be performed. A typical sequence is as follows:

1. Update the configuration register (ADCCFG) to select the input clock source and the divide ratio used to generate the internal clock, ADCK. This register is also used for selecting sample time and low-power configuration.

2. Update status and control register 2 (ADCSC2) to select the conversion trigger (hardware or software) and compare function options, if enabled.
3. Update status and control register 1 (ADCSC1) to select whether conversions will be continuous or completed only once, and to enable or disable conversion complete interrupts. The input channel on which conversions will be performed is also selected here.

### 12.5.1.2 Pseudo-Code Example

In this example, the ADC module is set up with interrupts enabled to perform a single 10-bit conversion at low power with a long sample time on input channel 1, where the internal ADCK clock is derived from the bus clock divided by 1.

#### ADCCFG = 0x98 (%10011000)

Bit 7	ADLPC	1	Configures for low power (lowers maximum clock speed)
Bit 6:5	ADIV	00	Sets the ADCK to the input clock ÷ 1
Bit 4	ADLSMP	1	Configures for long sample time
Bit 3:2	MODE	10	Sets mode at 10-bit conversions
Bit 1:0	ADICLK	00	Selects bus clock as input clock source

#### ADCSC2 = 0x00 (%00000000)

Bit 7	ADACT	0	Flag indicates if a conversion is in progress
Bit 6	ADTRG	0	Software trigger selected
Bit 5	ACFE	0	Compare function disabled
Bit 4	ACFGT	0	Not used in this example
Bit 3:2		00	Reserved, always reads zero
Bit 1:0		00	Reserved for Freescale's internal use; always write zero

#### ADCSC1 = 0x41 (%01000001)

Bit 7	COCO	0	Read-only flag which is set when a conversion completes
Bit 6	AIEN	1	Conversion complete interrupt enabled
Bit 5	ADCO	0	One conversion only (continuous conversions disabled)
Bit 4:0	ADCH	00001	Input channel 1 selected as ADC input channel

#### ADCRH/L = 0xxx

Holds results of conversion. Read high byte (ADCRH) before low byte (ADCRL) so that conversion data cannot be overwritten with data from the next conversion.

#### ADCCVH/L = 0xxx

Holds compare value when compare function enabled

#### APCTL1=0x02

AD1 pin I/O control disabled. All other AD pins remain general purpose I/O pins

#### APCTL2=0x00

All other AD pins remain general purpose I/O pins

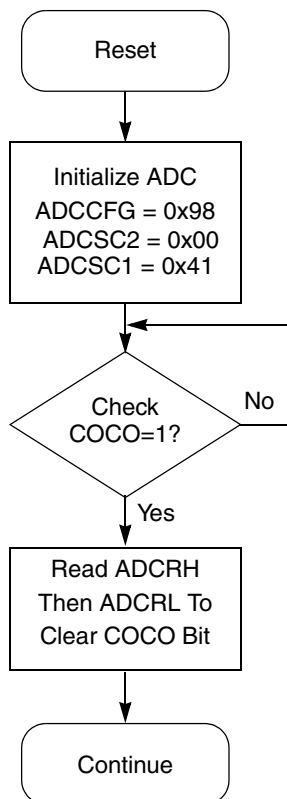

Figure 12-13. Initialization Flowchart for Example

## 12.6 Application Information

This section contains information for using the ADC module in applications. The ADC has been designed to be integrated into a microcontroller for use in embedded control applications requiring an A/D converter.

### 12.6.1 External Pins and Routing

The following sections discuss the external pins associated with the ADC module and how they should be used for best results.

#### 12.6.1.1 Analog Supply Pins

The ADC module has analog power and ground supplies ( $V_{DDA}$  and  $V_{SSA}$ ) available as separate pins on some devices.  $V_{SSA}$  is shared on the same pin as the MCU digital  $V_{SS}$  on some devices. On other devices,  $V_{SSA}$  and  $V_{DDA}$  are shared with the MCU digital supply pins. In these cases, there are separate pads for the analog supplies bonded to the same pin as the corresponding digital supply so that some degree of isolation between the supplies is maintained.

When available on a separate pin, both  $V_{DDA}$  and  $V_{SSA}$  must be connected to the same voltage potential as their corresponding MCU digital supply ( $V_{DD}$  and  $V_{SS}$ ) and must be routed carefully for maximum noise immunity and bypass capacitors placed as near as possible to the package.

If separate power supplies are used for analog and digital power, the ground connection between these supplies must be at the  $V_{SSA}$  pin. This should be the only ground connection between these supplies if possible. The  $V_{SSA}$  pin makes a good single point ground location.

### 12.6.1.2 Analog Reference Pins

In addition to the analog supplies, the ADC module has connections for two reference voltage inputs. The high reference is  $V_{REFH}$ , which may be shared on the same pin as  $V_{DDA}$  on some devices. The low reference is  $V_{REFL}$ , which may be shared on the same pin as  $V_{SSA}$  on some devices.

When available on a separate pin,  $V_{REFH}$  may be connected to the same potential as  $V_{DDA}$ , or may be driven by an external source between the minimum  $V_{DDA}$  spec and the  $V_{DDA}$  potential ( $V_{REFH}$  must never exceed  $V_{DDA}$ ). When available on a separate pin,  $V_{REFL}$  must be connected to the same voltage potential as  $V_{SSA}$ .  $V_{REFH}$  and  $V_{REFL}$  must be routed carefully for maximum noise immunity and bypass capacitors placed as near as possible to the package.

AC current in the form of current spikes required to supply charge to the capacitor array at each successive approximation step is drawn through the  $V_{REFH}$  and  $V_{REFL}$  loop. The best external component to meet this current demand is a 0.1  $\mu\text{F}$  capacitor with good high frequency characteristics. This capacitor is connected between  $V_{REFH}$  and  $V_{REFL}$  and must be placed as near as possible to the package pins. Resistance in the path is not recommended because the current causes a voltage drop that could result in conversion errors. Inductance in this path must be minimum (parasitic only).

### 12.6.1.3 Analog Input Pins

The external analog inputs are typically shared with digital I/O pins on MCU devices. The pin I/O control is disabled by setting the appropriate control bit in one of the pin control registers. Conversions can be performed on inputs without the associated pin control register bit set. It is recommended that the pin control register bit always be set when using a pin as an analog input. This avoids problems with contention because the output buffer is in its high impedance state and the pullup is disabled. Also, the input buffer draws DC current when its input is not at  $V_{DD}$  or  $V_{SS}$ . Setting the pin control register bits for all pins used as analog inputs should be done to achieve lowest operating current.

Empirical data shows that capacitors on the analog inputs improve performance in the presence of noise or when the source impedance is high. Use of 0.01  $\mu\text{F}$  capacitors with good high-frequency characteristics is sufficient. These capacitors are not necessary in all cases, but when used they must be placed as near as possible to the package pins and be referenced to  $V_{SSA}$ .

For proper conversion, the input voltage must fall between  $V_{REFH}$  and  $V_{REFL}$ . If the input is equal to or exceeds  $V_{REFH}$ , the converter circuit converts the signal to 0xFFF (full scale 12-bit representation), 0x3FF (full scale 10-bit representation) or 0xFF (full scale 8-bit representation). If the input is equal to or less than  $V_{REFL}$ , the converter circuit converts it to 0x000. Input voltages between  $V_{REFH}$  and  $V_{REFL}$  are straight-line linear conversions. There is a brief current associated with  $V_{REFL}$  when the sampling

capacitor is charging. The input is sampled for 3.5 cycles of the ADCK source when ADLSMP is low, or 23.5 cycles when ADLSMP is high.

For minimal loss of accuracy due to current injection, pins adjacent to the analog input pins should not be transitioning during conversions.

## 12.6.2 Sources of Error

Several sources of error exist for A/D conversions. These are discussed in the following sections.

### 12.6.2.1 Sampling Error

For proper conversions, the input must be sampled long enough to achieve the proper accuracy. Given the maximum input resistance of approximately 7k $\Omega$  and input capacitance of approximately 5.5 pF, sampling to within 1/4LSB (at 12-bit resolution) can be achieved within the minimum sample window (3.5 cycles @ 8 MHz maximum ADCK frequency) provided the resistance of the external analog source ( $R_{AS}$ ) is kept below 2 k $\Omega$ .

Higher source resistances or higher-accuracy sampling is possible by setting ADLSMP (to increase the sample window to 23.5 cycles) or decreasing ADCK frequency to increase sample time.

### 12.6.2.2 Pin Leakage Error

Leakage on the I/O pins can cause conversion error if the external analog source resistance ( $R_{AS}$ ) is high. If this error cannot be tolerated by the application, keep  $R_{AS}$  lower than  $V_{DDA} / (2^N * I_{LEAK})$  for less than 1/4LSB leakage error ( $N = 8$  in 8-bit, 10 in 10-bit or 12 in 12-bit mode).

### 12.6.2.3 Noise-Induced Errors

System noise that occurs during the sample or conversion process can affect the accuracy of the conversion. The ADC accuracy numbers are guaranteed as specified only if the following conditions are met:

- There is a 0.1  $\mu$ F low-ESR capacitor from  $V_{REFH}$  to  $V_{REFL}$ .
- There is a 0.1  $\mu$ F low-ESR capacitor from  $V_{DDA}$  to  $V_{SSA}$ .
- If inductive isolation is used from the primary supply, an additional 1  $\mu$ F capacitor is placed from  $V_{DDA}$  to  $V_{SSA}$ .
- $V_{SSA}$  (and  $V_{REFL}$ , if connected) is connected to  $V_{SS}$  at a quiet point in the ground plane.
- Operate the MCU in wait or stop3 mode before initiating (hardware triggered conversions) or immediately after initiating (hardware or software triggered conversions) the ADC conversion.
  - For software triggered conversions, immediately follow the write to ADCSC1 with a wait instruction or stop instruction.
  - For stop3 mode operation, select ADACK as the clock source. Operation in stop3 reduces  $V_{DD}$  noise but increases effective conversion time due to stop recovery.
- There is no I/O switching, input or output, on the MCU during the conversion.



There are some situations where external system activity causes radiated or conducted noise emissions or excessive  $V_{DD}$  noise is coupled into the ADC. In these situations, or when the MCU cannot be placed in wait or stop3 or I/O activity cannot be halted, these recommended actions may reduce the effect of noise on the accuracy:

- Place a 0.01  $\mu\text{F}$  capacitor ( $C_{AS}$ ) on the selected input channel to  $V_{REFL}$  or  $V_{SSA}$  (this improves noise issues, but affects the sample rate based on the external analog source resistance).
- Average the result by converting the analog input many times in succession and dividing the sum of the results. Four samples are required to eliminate the effect of a 1LSB, one-time error.
- Reduce the effect of synchronous noise by operating off the asynchronous clock (ADACK) and averaging. Noise that is synchronous to ADCK cannot be averaged out.

### 12.6.2.4 Code Width and Quantization Error

The ADC quantizes the ideal straight-line transfer function into 4096 steps (in 12-bit mode). Each step ideally has the same height (1 code) and width. The width is defined as the delta between the transition points to one code and the next. The ideal code width for an N bit converter (in this case N can be 8, 10 or 12), defined as 1LSB, is:

$$1 \text{ lsb} = (V_{REFH} - V_{REFL}) / 2^N \quad \text{Eqn. 12-1}$$

There is an inherent quantization error due to the digitization of the result. For 8-bit or 10-bit conversions the code transitions when the voltage is at the midpoint between the points where the straight line transfer function is exactly represented by the actual transfer function. Therefore, the quantization error will be  $\pm 1/2$  lsb in 8- or 10-bit mode. As a consequence, however, the code width of the first (0x000) conversion is only 1/2 lsb and the code width of the last (0xFF or 0x3FF) is 1.5 lsb.

For 12-bit conversions the code transitions only after the full code width is present, so the quantization error is  $-1$  lsb to 0 lsb and the code width of each step is 1 lsb.

### 12.6.2.5 Linearity Errors

The ADC may also exhibit non-linearity of several forms. Every effort has been made to reduce these errors but the system should be aware of them because they affect overall accuracy. These errors are:

- Zero-scale error ( $E_{ZS}$ ) (sometimes called offset) — This error is defined as the difference between the actual code width of the first conversion and the ideal code width (1/2 lsb in 8-bit or 10-bit modes and 1 lsb in 12-bit mode). If the first conversion is 0x001, the difference between the actual 0x001 code width and its ideal (1 lsb) is used.
- Full-scale error ( $E_{FS}$ ) — This error is defined as the difference between the actual code width of the last conversion and the ideal code width (1.5 lsb in 8-bit or 10-bit modes and 1LSB in 12-bit mode). If the last conversion is 0x3FE, the difference between the actual 0x3FE code width and its ideal (1LSB) is used.
- Differential non-linearity (DNL) — This error is defined as the worst-case difference between the actual code width and the ideal code width for all conversions.



- Integral non-linearity (INL) — This error is defined as the highest-value the (absolute value of the) running sum of DNL achieves. More simply, this is the worst-case difference of the actual transition voltage to a given code and its corresponding ideal transition voltage, for all codes.
- Total unadjusted error (TUE) — This error is defined as the difference between the actual transfer function and the ideal straight-line transfer function and includes all forms of error.

### 12.6.2.6 Code Jitter, Non-Monotonicity, and Missing Codes

Analog-to-digital converters are susceptible to three special forms of error. These are code jitter, non-monotonicity, and missing codes.

Code jitter is when, at certain points, a given input voltage converts to one of two values when sampled repeatedly. Ideally, when the input voltage is infinitesimally smaller than the transition voltage, the converter yields the lower code (and vice-versa). However, even small amounts of system noise can cause the converter to be indeterminate (between two codes) for a range of input voltages around the transition voltage. This range is normally around  $\pm 1/2$  lsb in 8-bit or 10-bit mode, or around 2 lsb in 12-bit mode, and increases with noise.

This error may be reduced by repeatedly sampling the input and averaging the result. Additionally the techniques discussed in [Section 12.6.2.3](#) reduces this error.

Non-monotonicity is defined as when, except for code jitter, the converter converts to a lower code for a higher input voltage. Missing codes are those values never converted for any input value.

In 8-bit or 10-bit mode, the ADC is guaranteed to be monotonic and have no missing codes.



# Chapter 13

## Serial Communications Interface (S08SCIV4)

### 13.1 Introduction

MC9S08FL16 series contain a serial communications interface module (SCI) that behavior as a UART. The SCI module supports single-wire mode and LIN-extension.

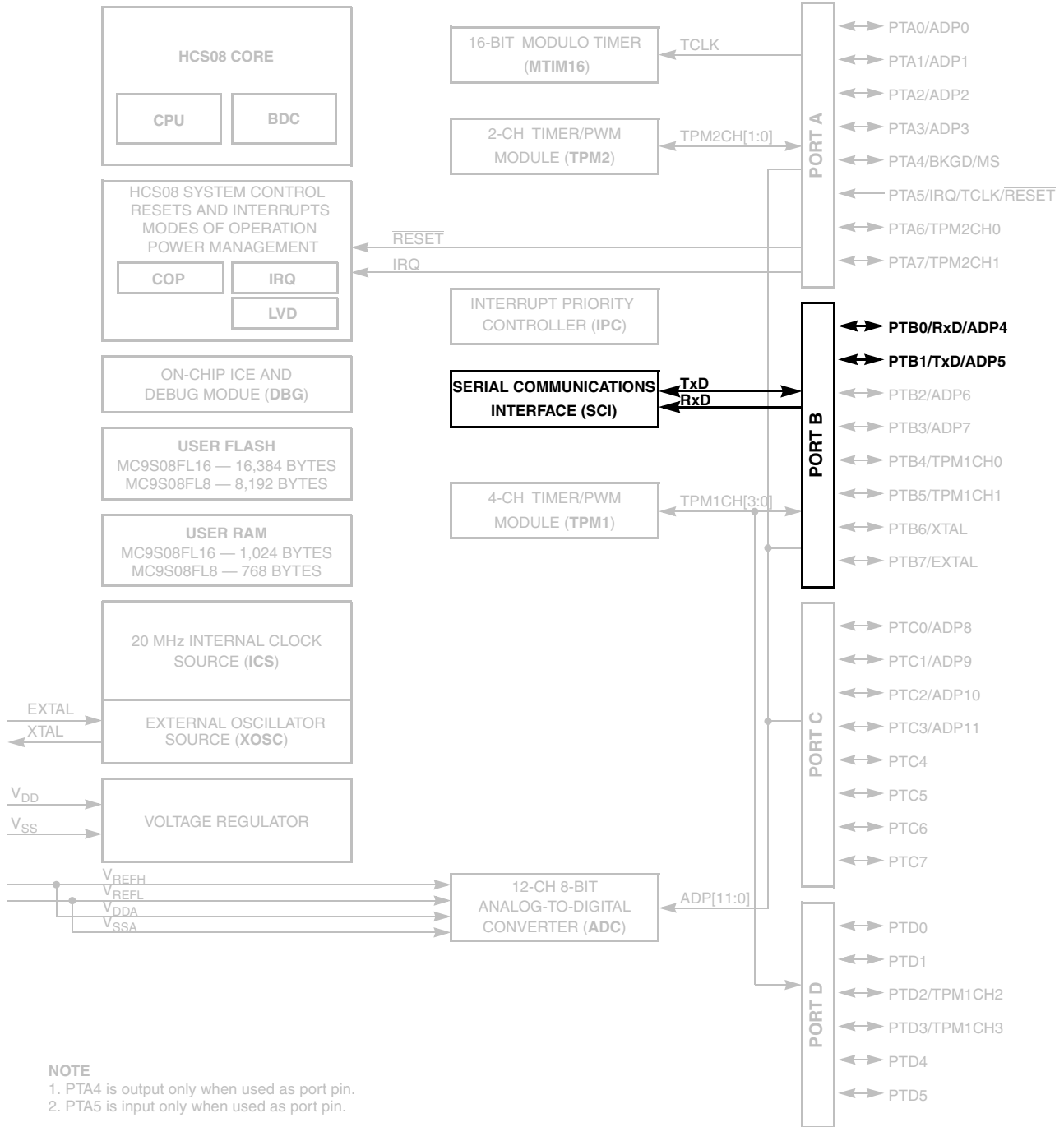

Figure 13-1. MC9S08FL16 Series Block Diagram Highlighting SCI Module and Pins

### 13.1.1 Features

Features of SCI module include:

- Full-duplex, standard non-return-to-zero (NRZ) format
- Double-buffered transmitter and receiver with separate enables
- Programmable baud rates (13-bit modulo divider)
- Interrupt-driven or polled operation:
  - Transmit data register empty and transmission complete
  - Receive data register full
  - Receive overrun, parity error, framing error, and noise error
  - Idle receiver detect
  - Active edge on receive pin
  - Break detect supporting LIN
- Hardware parity generation and checking
- Programmable 8-bit or 9-bit character length
- Receiver wakeup by idle-line or address-mark
- Optional 13-bit break character generation / 11-bit break character detection
- Selectable transmitter output polarity

### 13.1.2 Modes of Operation

See [Section 13.3, “Functional Description,”](#) For details concerning SCI operation in these modes:

- 8- and 9-bit data modes
- Stop mode operation
- Loop mode
- Single-wire mode

### 13.1.3 Block Diagram

[Figure 13-2](#) shows the transmitter portion of the SCI.

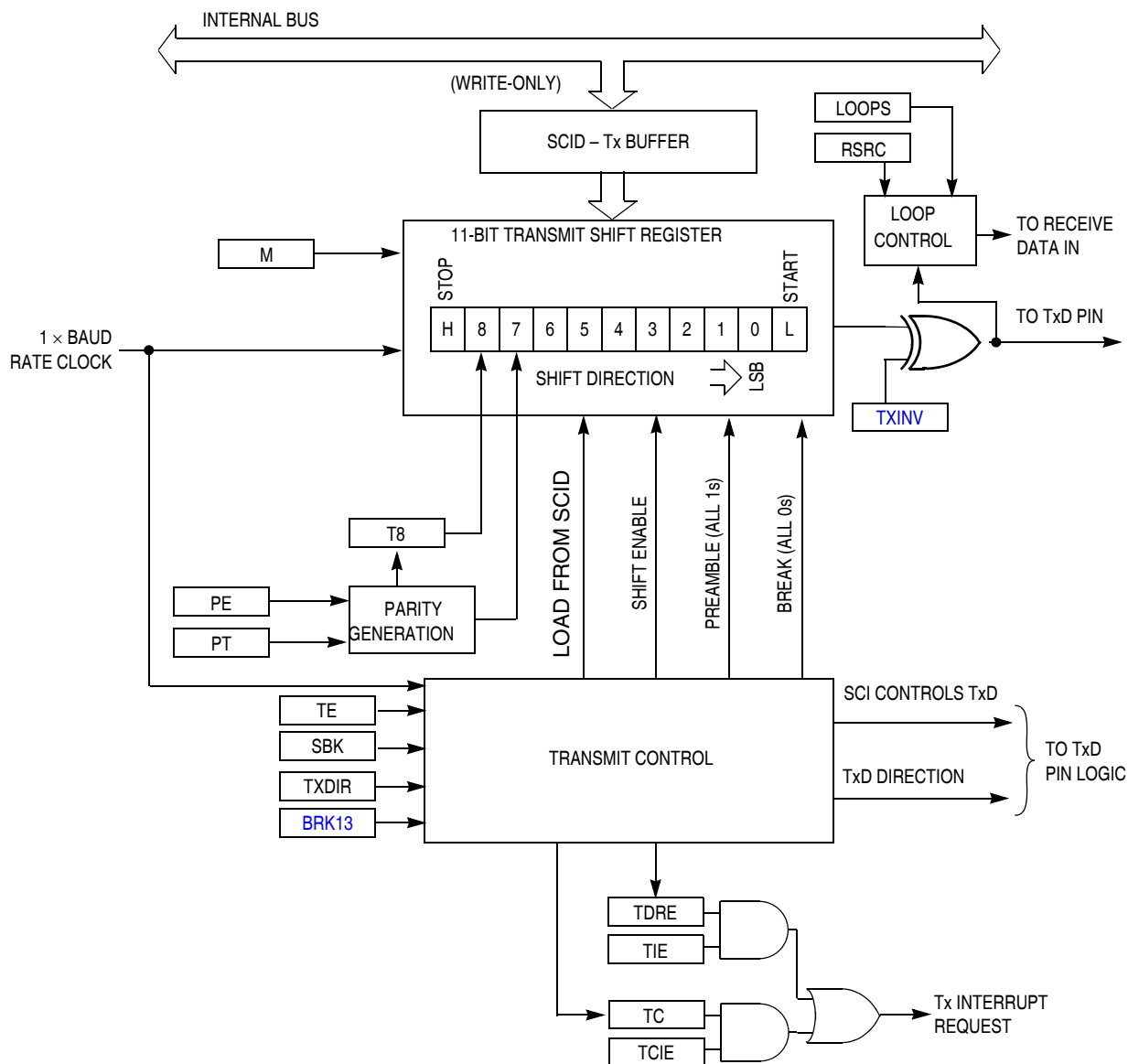

Figure 13-2. SCI Transmitter Block Diagram

Figure 13-3 shows the receiver portion of the SCI.

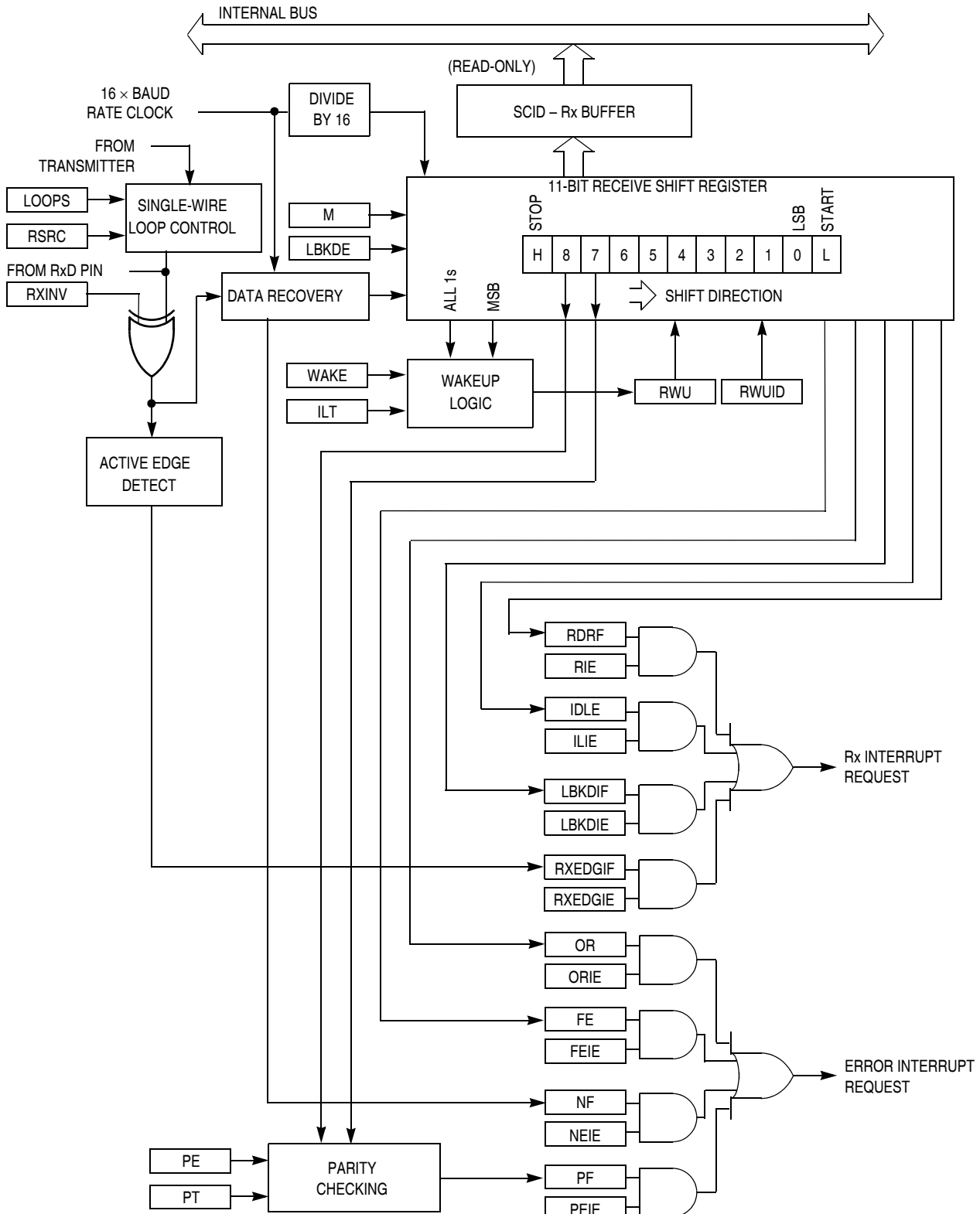

Figure 13-3. SCI Receiver Block Diagram

## 13.2 Register Definition

The SCI has eight 8-bit registers to control baud rate, select SCI options, report SCI status, and for transmit/receive data.

Refer to the direct-page register summary in the [Memory](#) chapter of this data sheet for the absolute address assignments for all SCI registers. This section refers to registers and control bits only by their names. A Freescale-provided equate or header file is used to translate these names into the appropriate absolute addresses.

### 13.2.1 SCI Baud Rate Registers (SCIBDH, SCIBDL)

This pair of registers controls the prescale divisor for SCI baud rate generation. To update the 13-bit baud rate setting [SBR12:SBR0], first write to SCIBDH to buffer the high half of the new value and then write to SCIBDL. The working value in SCIBDH does not change until SCIBDL is written.

SCIBDL is reset to a non-zero value, so after reset the baud rate generator remains disabled until the first time the receiver or transmitter is enabled (RE or TE bits in SCIC2 are written to 1).

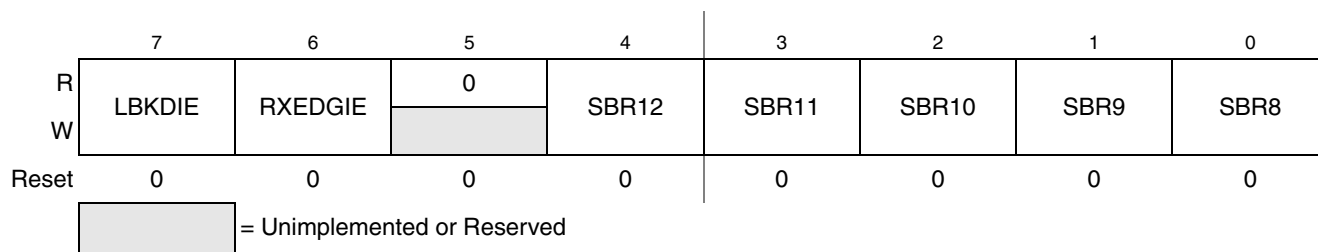

Figure 13-4. SCI Baud Rate Register (SCIBDH)

Table 13-1. SCIBDH Field Descriptions

Field	Description
7 LBKDIE	<b>LIN Break Detect Interrupt Enable (for LBKDIF)</b> 0 Hardware interrupts from LBKDIF disabled (use polling). 1 Hardware interrupt requested when LBKDIF flag is 1.
6 RXEDGIE	<b>RxD Input Active Edge Interrupt Enable (for RXEDGIF)</b> 0 Hardware interrupts from RXEDGIF disabled (use polling). 1 Hardware interrupt requested when RXEDGIF flag is 1.
4:0 SBR[12:8]	<b>Baud Rate Modulo Divisor</b> — The 13 bits in SBR[12:0] are referred to collectively as BR, and they set the modulo divide rate for the SCI baud rate generator. When BR = 0, the SCI baud rate generator is disabled to reduce supply current. When BR = 1 to 8191, the SCI baud rate = $BUSCLK/(16 \times BR)$ . See also BR bits in <a href="#">Table 13-2</a> .

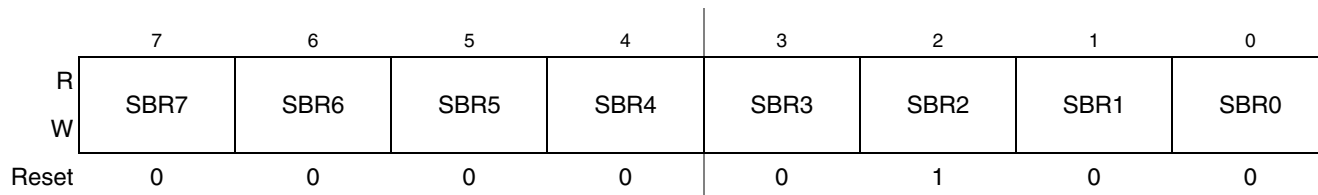

Figure 13-5. SCI Baud Rate Register (SCIBDL)

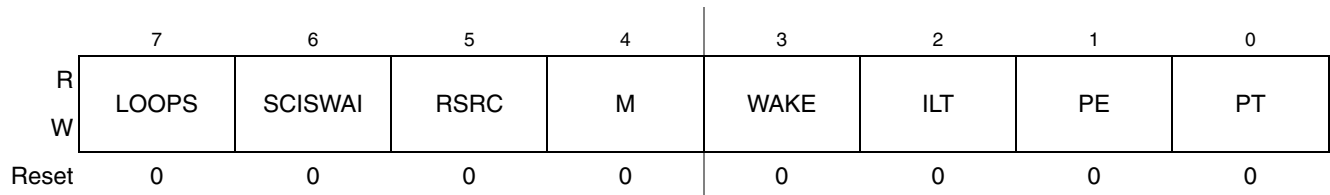

**Table 13-2. SCIBDL Field Descriptions**

Field	Description
7:0 SBR[7:0]	<b>Baud Rate Modulo Divisor</b> — These 13 bits in SBR[12:0] are referred to collectively as BR, and they set the modulo divide rate for the SCI baud rate generator. When BR = 0, the SCI baud rate generator is disabled to reduce supply current. When BR = 1 to 8191, the SCI baud rate = $BUSCLK/(16 \times BR)$ . See also BR bits in <a href="#">Table 13-1</a> .

## 13.2.2 SCI Control Register 1 (SCIC1)

This read/write register is used to control various optional features of the SCI system.

**Figure 13-6. SCI Control Register 1 (SCIC1)**
**Table 13-3. SCIC1 Field Descriptions**

Field	Description
7 LOOPS	<b>Loop Mode Select</b> — Selects between loop back modes and normal 2-pin full-duplex modes. When LOOPS = 1, the transmitter output is internally connected to the receiver input. 0 Normal operation — RxD and TxD use separate pins. 1 Loop mode or single-wire mode where transmitter outputs are internally connected to receiver input. (See <a href="#">RSRC</a> bit.) RxD pin is not used by SCI.
6 SCISWAI	<b>SCI Stops in Wait Mode</b> 0 SCI clocks continue to run in wait mode so the SCI can be the source of an interrupt that wakes up the CPU. 1 SCI clocks freeze while CPU is in wait mode.
5 RSRC	<b>Receiver Source Select</b> — This bit has no meaning or effect unless the LOOPS bit is set to 1. When LOOPS = 1, the receiver input is internally connected to the TxD pin and RSRC determines whether this connection is also connected to the transmitter output. 0 Provided LOOPS = 1, RSRC = 0 selects internal loop back mode and the SCI does not use the RxD pins. 1 Single-wire SCI mode where the TxD pin is connected to the transmitter output and receiver input.
4 M	<b>9-Bit or 8-Bit Mode Select</b> 0 Normal — start + 8 data bits (LSB first) + stop. 1 Receiver and transmitter use 9-bit data characters start + 8 data bits (LSB first) + 9th data bit + stop.
3 WAKE	<b>Receiver Wakeup Method Select</b> — Refer to <a href="#">Section 13.3.3.2, “Receiver Wakeup Operation”</a> for more information. 0 Idle-line wakeup. 1 Address-mark wakeup.
2 ILT	<b>Idle Line Type Select</b> — Setting this bit to 1 ensures that the stop bit and logic 1 bits at the end of a character do not count toward the 10 or 11 bit times of logic high level needed by the idle line detection logic. Refer to <a href="#">Section 13.3.3.2.1, “Idle-Line Wakeup”</a> for more information. 0 Idle character bit count starts after start bit. 1 Idle character bit count starts after stop bit.

**Table 13-3. SCIC1 Field Descriptions (continued)**

Field	Description
1 PE	<b>Parity Enable</b> — Enables hardware parity generation and checking. When parity is enabled, the most significant bit (MSB) of the data character (eighth or ninth data bit) is treated as the parity bit. 0 No hardware parity generation or checking. 1 Parity enabled.
0 PT	<b>Parity Type</b> — Provided parity is enabled (PE = 1), this bit selects even or odd parity. Odd parity means the total number of 1s in the data character, including the parity bit, is odd. Even parity means the total number of 1s in the data character, including the parity bit, is even. 0 Even parity. 1 Odd parity.

### 13.2.3 SCI Control Register 2 (SCIC2)

This register can be read or written at any time.

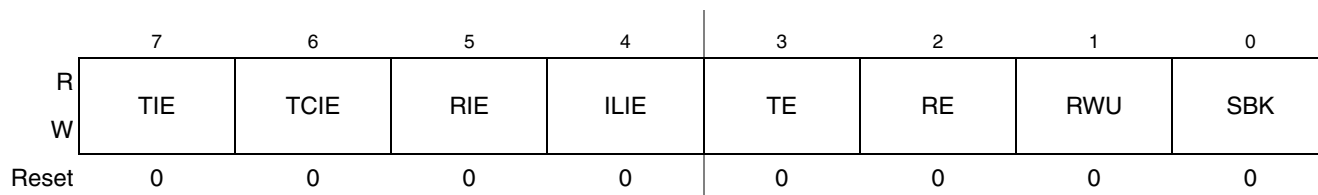

**Figure 13-7. SCI Control Register 2 (SCIC2)**

**Table 13-4. SCIC2 Field Descriptions**

Field	Description
7 TIE	<b>Transmit Interrupt Enable (for TDRE)</b> 0 Hardware interrupts from TDRE disabled (use polling). 1 Hardware interrupt requested when TDRE flag is 1.
6 TCIE	<b>Transmission Complete Interrupt Enable (for TC)</b> 0 Hardware interrupts from TC disabled (use polling). 1 Hardware interrupt requested when TC flag is 1.
5 RIE	<b>Receiver Interrupt Enable (for RDRF)</b> 0 Hardware interrupts from RDRF disabled (use polling). 1 Hardware interrupt requested when RDRF flag is 1.
4 ILIE	<b>Idle Line Interrupt Enable (for IDLE)</b> 0 Hardware interrupts from IDLE disabled (use polling). 1 Hardware interrupt requested when IDLE flag is 1.
3 TE	<b>Transmitter Enable</b> 0 Transmitter off. 1 Transmitter on. TE must be 1 in order to use the SCI transmitter. When TE = 1, the SCI forces the TxD pin to act as an output for the SCI system. When the SCI is configured for single-wire operation (LOOPS = RSRC = 1), TXDIR controls the direction of traffic on the single SCI communication line (TxD pin). TE also can be used to queue an idle character by writing TE = 0 then TE = 1 while a transmission is in progress. Refer to <a href="#">Section 13.3.2.1, “Send Break and Queued Idle”</a> for more details. When TE is written to 0, the transmitter keeps control of the port TxD pin until any data, queued idle, or queued break character finishes transmitting before allowing the pin to revert to a general-purpose I/O pin.

**Table 13-4. SCIC2 Field Descriptions (continued)**

Field	Description
2 RE	<b>Receiver Enable</b> — When the SCI receiver is off, the RxD pin reverts to being a general-purpose port I/O pin. If LOOPS = 1 the RxD pin reverts to being a general-purpose I/O pin even if RE = 1. 0 Receiver off. 1 Receiver on.
1 RWU	<b>Receiver Wakeup Control</b> — This bit can be written to 1 to place the SCI receiver in a standby state where it waits for automatic hardware detection of a selected wakeup condition. The wakeup condition is either an idle line between messages (WAKE = 0, idle-line wakeup), or a logic 1 in the most significant data bit in a character (WAKE = 1, address-mark wakeup). Application software sets RWU and (normally) a selected hardware condition automatically clears RWU. Refer to <a href="#">Section 13.3.3.2, “Receiver Wakeup Operation”</a> for more details. 0 Normal SCI receiver operation. 1 SCI receiver in standby waiting for wakeup condition.
0 SBK	<b>Send Break</b> — Writing a 1 and then a 0 to SBK queues a break character in the transmit data stream. Additional break characters of 10 or 11 (13 or 14 if BRK13 = 1) bit times of logic 0 are queued as long as SBK = 1. Depending on the timing of the set and clear of SBK relative to the information currently being transmitted, a second break character may be queued before software clears SBK. Refer to <a href="#">Section 13.3.2.1, “Send Break and Queued Idle”</a> for more details. 0 Normal transmitter operation. 1 Queue break character(s) to be sent.

### 13.2.4 SCI Status Register 1 (SCIS1)

This register has eight read-only status flags. Writes have no effect. Special software sequences (which do not involve writing to this register) are used to clear these status flags.

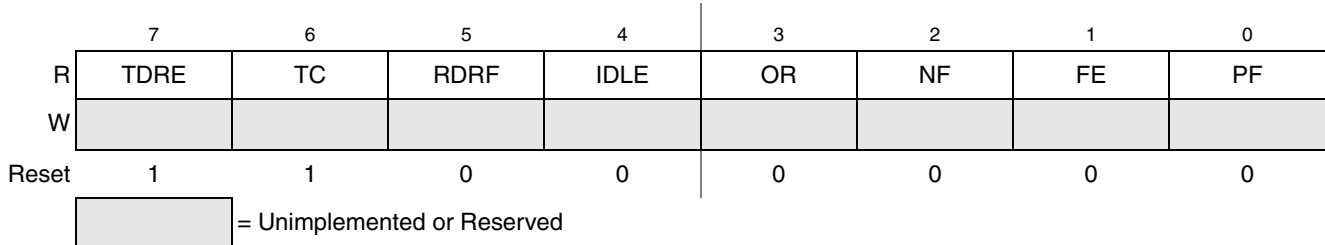

**Figure 13-8. SCI Status Register 1 (SCIS1)**

**Table 13-5. SCIS1 Field Descriptions**

Field	Description
7 TDRE	<p><b>Transmit Data Register Empty Flag</b> — TDRE is set out of reset and when a transmit data value transfers from the transmit data buffer to the transmit shifter, leaving room for a new character in the buffer. To clear TDRE, read SCIS1 with TDRE = 1 and then write to the SCI data register (SCID).</p> <p>0 Transmit data register (buffer) full. 1 Transmit data register (buffer) empty.</p>
6 TC	<p><b>Transmission Complete Flag</b> — TC is set out of reset and when TDRE = 1 and no data, preamble, or break character is being transmitted.</p> <p>0 Transmitter active (sending data, a preamble, or a break). 1 Transmitter idle (transmission activity complete).</p> <p>TC is cleared automatically by reading SCIS1 with TC = 1 and then doing one of the following three things:</p> <ul style="list-style-type: none"> <li>• Write to the SCI data register (SCID) to transmit new data</li> <li>• Queue a preamble by changing TE from 0 to 1</li> <li>• Queue a break character by writing 1 to SBK in SCIC2</li> </ul>
5 RDRF	<p><b>Receive Data Register Full Flag</b> — RDRF becomes set when a character transfers from the receive shifter into the receive data register (SCID). To clear RDRF, read SCIS1 with RDRF = 1 and then read the SCI data register (SCID).</p> <p>0 Receive data register empty. 1 Receive data register full.</p>
4 IDLE	<p><b>Idle Line Flag</b> — IDLE is set when the SCI receive line becomes idle for a full character time after a period of activity. When ILT = 0, the receiver starts counting idle bit times after the start bit. So if the receive character is all 1s, these bit times and the stop bit time count toward the full character time of logic high (10 or 11 bit times depending on the M control bit) needed for the receiver to detect an idle line. When ILT = 1, the receiver doesn't start counting idle bit times until after the stop bit. So the stop bit and any logic high bit times at the end of the previous character do not count toward the full character time of logic high needed for the receiver to detect an idle line.</p> <p>To clear IDLE, read SCIS1 with IDLE = 1 and then read the SCI data register (SCID). After IDLE has been cleared, it cannot become set again until after a new character has been received and RDRF has been set. IDLE will get set only once even if the receive line remains idle for an extended period.</p> <p>0 No idle line detected. 1 Idle line was detected.</p>
3 OR	<p><b>Receiver Overrun Flag</b> — OR is set when a new serial character is ready to be transferred to the receive data register (buffer), but the previously received character has not been read from SCID yet. In this case, the new character (and all associated error information) is lost because there is no room to move it into SCID. To clear OR, read SCIS1 with OR = 1 and then read the SCI data register (SCID).</p> <p>0 No overrun. 1 Receive overrun (new SCI data lost).</p>
2 NF	<p><b>Noise Flag</b> — The advanced sampling technique used in the receiver takes seven samples during the start bit and three samples in each data bit and the stop bit. If any of these samples disagrees with the rest of the samples within any bit time in the frame, the flag NF will be set at the same time as the flag RDRF gets set for the character. To clear NF, read SCIS1 and then read the SCI data register (SCID).</p> <p>0 No noise detected. 1 Noise detected in the received character in SCID.</p>

**Table 13-5. SCIS1 Field Descriptions (continued)**

Field	Description
1 FE	<b>Framing Error Flag</b> — FE is set at the same time as RDRF when the receiver detects a logic 0 where the stop bit was expected. This suggests the receiver was not properly aligned to a character frame. To clear FE, read SCIS1 with FE = 1 and then read the SCI data register (SCID). 0 No framing error detected. This does not guarantee the framing is correct. 1 Framing error.
0 PF	<b>Parity Error Flag</b> — PF is set at the same time as RDRF when parity is enabled (PE = 1) and the parity bit in the received character does not agree with the expected parity value. To clear PF, read SCIS1 and then read the SCI data register (SCID). 0 No parity error. 1 Parity error.

### 13.2.5 SCI Status Register 2 (SCIS2)

This register has one read-only status flag.

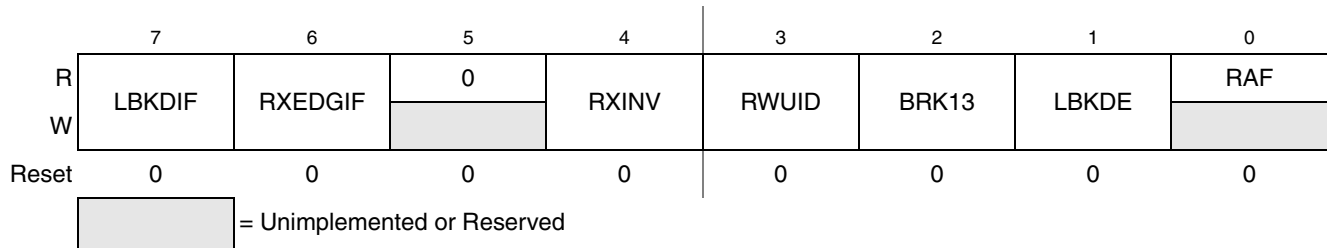

**Figure 13-9. SCI Status Register 2 (SCIS2)**

**Table 13-6. SCIS2 Field Descriptions**

Field	Description
7 LBKDIF	<b>LIN Break Detect Interrupt Flag</b> — LBKDIF is set when the LIN break detect circuitry is enabled and a LIN break character is detected. LBKDIF is cleared by writing a “1” to it. 0 No LIN break character has been detected. 1 LIN break character has been detected.
6 RXEDGIF	<b>RxD Pin Active Edge Interrupt Flag</b> — RXEDGIF is set when an active edge (falling if RXINV = 0, rising if RXINV=1) on the RxD pin occurs. RXEDGIF is cleared by writing a “1” to it. 0 No active edge on the receive pin has occurred. 1 An active edge on the receive pin has occurred.
4 RXINV <sup>1</sup>	<b>Receive Data Inversion</b> — Setting this bit reverses the polarity of the received data input. 0 Receive data not inverted 1 Receive data inverted
3 RWUID	<b>Receive Wake Up Idle Detect</b> — RWUID controls whether the idle character that wakes up the receiver sets the IDLE bit. 0 During receive standby state (RWU = 1), the IDLE bit does not get set upon detection of an idle character. 1 During receive standby state (RWU = 1), the IDLE bit gets set upon detection of an idle character.
2 BRK13	<b>Break Character Generation Length</b> — BRK13 is used to select a longer transmitted break character length. Detection of a framing error is not affected by the state of this bit. 0 Break character is transmitted with length of 10 bit times (11 if M = 1) 1 Break character is transmitted with length of 13 bit times (14 if M = 1)

**Table 13-6. SCIS2 Field Descriptions (continued)**

Field	Description
1 LBKDE	<b>LIN Break Detection Enable</b> — LBKDE is used to select a longer break character detection length. While LBKDE is set, framing error (FE) and receive data register full (RDRF) flags are prevented from setting. 0 Break character is detected at length of 10 bit times (11 if M = 1). 1 Break character is detected at length of 11 bit times (12 if M = 1).
0 RAF	<b>Receiver Active Flag</b> — RAF is set when the SCI receiver detects the beginning of a valid start bit, and RAF is cleared automatically when the receiver detects an idle line. This status flag can be used to check whether an SCI character is being received before instructing the MCU to go to stop mode. 0 SCI receiver idle waiting for a start bit. 1 SCI receiver active (RxD input not idle).

<sup>1</sup> Setting RXINV inverts the RxD input for all cases: data bits, start and stop bits, break, and idle.

When using an internal oscillator in a LIN system, it is necessary to raise the break detection threshold by one bit time. Under the worst case timing conditions allowed in LIN, it is possible that a 0x00 data character can appear to be 10.26 bit times long at a slave which is running 14% faster than the master. This would trigger normal break detection circuitry which is designed to detect a 10 bit break symbol. When the LBKDE bit is set, framing errors are inhibited and the break detection threshold changes from 10 bits to 11 bits, preventing false detection of a 0x00 data character as a LIN break symbol.

### 13.2.6 SCI Control Register 3 (SCIC3)

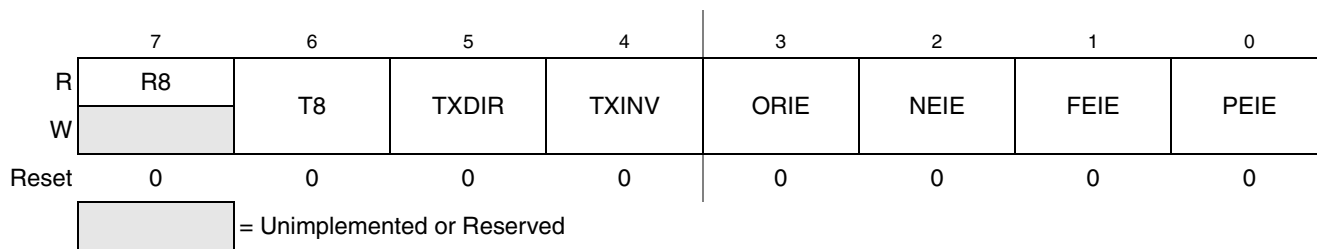

**Figure 13-10. SCI Control Register 3 (SCIC3)**

**Table 13-7. SCIC3 Field Descriptions**

Field	Description
7 R8	<b>Ninth Data Bit for Receiver</b> — When the SCI is configured for 9-bit data (M = 1), R8 can be thought of as a ninth receive data bit to the left of the MSB of the buffered data in the SCID register. When reading 9-bit data, read R8 before reading SCID because reading SCID completes automatic flag clearing sequences which could allow R8 and SCID to be overwritten with new data.
6 T8	<b>Ninth Data Bit for Transmitter</b> — When the SCI is configured for 9-bit data (M = 1), T8 may be thought of as a ninth transmit data bit to the left of the MSB of the data in the SCID register. When writing 9-bit data, the entire 9-bit value is transferred to the SCI shift register after SCID is written so T8 should be written (if it needs to change from its previous value) before SCID is written. If T8 does not need to change in the new value (such as when it is used to generate mark or space parity), it need not be written each time SCID is written.
5 TXDIR	<b>TxD Pin Direction in Single-Wire Mode</b> — When the SCI is configured for single-wire half-duplex operation (LOOPS = RSRC = 1), this bit determines the direction of data at the TxD pin. 0 TxD pin is an input in single-wire mode. 1 TxD pin is an output in single-wire mode.

**Table 13-7. SCIC3 Field Descriptions (continued)**

Field	Description
4 TXINV <sup>1</sup>	<b>Transmit Data Inversion</b> — Setting this bit reverses the polarity of the transmitted data output. 0 Transmit data not inverted 1 Transmit data inverted
3 ORIE	<b>Overrun Interrupt Enable</b> — This bit enables the overrun flag (OR) to generate hardware interrupt requests. 0 OR interrupts disabled (use polling). 1 Hardware interrupt requested when OR = 1.
2 NEIE	<b>Noise Error Interrupt Enable</b> — This bit enables the noise flag (NF) to generate hardware interrupt requests. 0 NF interrupts disabled (use polling). 1 Hardware interrupt requested when NF = 1.
1 FEIE	<b>Framing Error Interrupt Enable</b> — This bit enables the framing error flag (FE) to generate hardware interrupt requests. 0 FE interrupts disabled (use polling). 1 Hardware interrupt requested when FE = 1.
0 PEIE	<b>Parity Error Interrupt Enable</b> — This bit enables the parity error flag (PF) to generate hardware interrupt requests. 0 PF interrupts disabled (use polling). 1 Hardware interrupt requested when PF = 1.

<sup>1</sup> Setting TXINV inverts the TxD output for all cases: data bits, start and stop bits, break, and idle.

## 13.2.7 SCI Data Register (SCID)

This register is actually two separate registers. Reads return the contents of the read-only receive data buffer and writes go to the write-only transmit data buffer. Reads and writes of this register are also involved in the automatic flag clearing mechanisms for the SCI status flags.

	7	6	5	4	3	2	1	0
R	R7	R6	R5	R4	R3	R2	R1	R0
W	T7	T6	T5	T4	T3	T2	T1	T0
Reset	0	0	0	0	0	0	0	0

**Figure 13-11. SCI Data Register (SCID)**

## 13.3 Functional Description

The SCI allows full-duplex, asynchronous, NRZ serial communication among the MCU and remote devices, including other MCUs. The SCI comprises a baud rate generator, transmitter, and receiver block. The transmitter and receiver operate independently, although they use the same baud rate generator. During normal operation, the MCU monitors the status of the SCI, writes the data to be transmitted, and processes received data. The following describes each of the blocks of the SCI.

### 13.3.1 Baud Rate Generation

As shown in [Figure 13-12](#), the clock source for the SCI baud rate generator is the bus-rate clock.

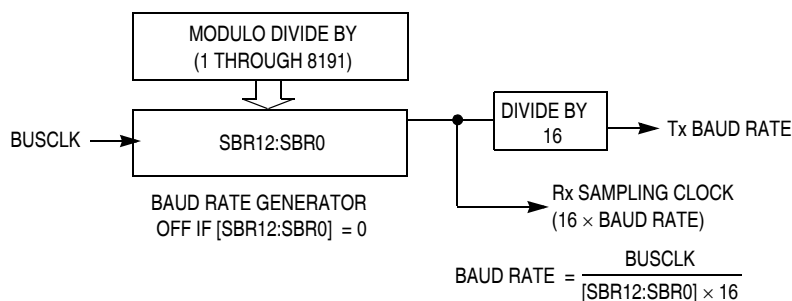

**Figure 13-12. SCI Baud Rate Generation**

SCI communications require the transmitter and receiver (which typically derive baud rates from independent clock sources) to use the same baud rate. Allowed tolerance on this baud frequency depends on the details of how the receiver synchronizes to the leading edge of the start bit and how bit sampling is performed.

The MCU resynchronizes to bit boundaries on every high-to-low transition, but in the worst case, there are no such transitions in the full 10- or 11-bit time character frame so any mismatch in baud rate is accumulated for the whole character time. For a Freescale Semiconductor SCI system whose bus frequency is driven by a crystal, the allowed baud rate mismatch is about  $\pm 4.5$  percent for 8-bit data format and about  $\pm 4$  percent for 9-bit data format. Although baud rate modulo divider settings do not always produce baud rates that exactly match standard rates, it is normally possible to get within a few percent, which is acceptable for reliable communications.

### 13.3.2 Transmitter Functional Description

This section describes the overall block diagram for the SCI transmitter, as well as specialized functions for sending break and idle characters. The transmitter block diagram is shown in [Figure 13-2](#).

The transmitter output (TxD) idle state defaults to logic high ( $TXINV = 0$  following reset). The transmitter output is inverted by setting  $TXINV = 1$ . The transmitter is enabled by setting the TE bit in SCIC2. This queues a preamble character that is one full character frame of the idle state. The transmitter then remains idle until data is available in the transmit data buffer. Programs store data into the transmit data buffer by writing to the SCI data register (SCID).

The central element of the SCI transmitter is the transmit shift register that is either 10 or 11 bits long depending on the setting in the M control bit. For the remainder of this section, we will assume  $M = 0$ , selecting the normal 8-bit data mode. In 8-bit data mode, the shift register holds a start bit, eight data bits, and a stop bit. When the transmit shift register is available for a new SCI character, the value waiting in the transmit data register is transferred to the shift register (synchronized with the baud rate clock) and the transmit data register empty (TDRE) status flag is set to indicate another character may be written to the transmit data buffer at SCID.

If no new character is waiting in the transmit data buffer after a stop bit is shifted out the TxD pin, the transmitter sets the transmit complete flag and enters an idle mode, with TxD high, waiting for more characters to transmit.



Writing 0 to TE does not immediately release the pin to be a general-purpose I/O pin. Any transmit activity that is in progress must first be completed. This includes data characters in progress, queued idle characters, and queued break characters.

### 13.3.2.1 Send Break and Queued Idle

The SBK control bit in SCIC2 is used to send break characters which were originally used to gain the attention of old teletype receivers. Break characters are a full character time of logic 0 (10 bit times including the start and stop bits). A longer break of 13 bit times can be enabled by setting BRK13 = 1. Normally, a program would wait for TDRE to become set to indicate the last character of a message has moved to the transmit shifter, then write 1 and then write 0 to the SBK bit. This action queues a break character to be sent as soon as the shifter is available. If SBK is still 1 when the queued break moves into the shifter (synchronized to the baud rate clock), an additional break character is queued. If the receiving device is another Freescale Semiconductor SCI, the break characters will be received as 0s in all eight data bits and a framing error (FE = 1) occurs.

When idle-line wakeup is used, a full character time of idle (logic 1) is needed between messages to wake up any sleeping receivers. Normally, a program would wait for TDRE to become set to indicate the last character of a message has moved to the transmit shifter, then write 0 and then write 1 to the TE bit. This action queues an idle character to be sent as soon as the shifter is available. As long as the character in the shifter does not finish while TE = 0, the SCI transmitter never actually releases control of the TxD pin. If there is a possibility of the shifter finishing while TE = 0, set the general-purpose I/O controls so the pin that is shared with TxD is an output driving a logic 1. This ensures that the TxD line will look like a normal idle line even if the SCI loses control of the port pin between writing 0 and then 1 to TE.

The length of the break character is affected by the BRK13 and M bits as shown below.

**Table 13-8. Break Character Length**

BRK13	M	Break Character Length
0	0	10 bit times
0	1	11 bit times
1	0	13 bit times
1	1	14 bit times

### 13.3.3 Receiver Functional Description

In this section, the receiver block diagram (Figure 13-3) is used as a guide for the overall receiver functional description. Next, the data sampling technique used to reconstruct receiver data is described in more detail. Finally, two variations of the receiver wakeup function are explained.

The receiver input is inverted by setting RXINV = 1. The receiver is enabled by setting the RE bit in SCIC2. Character frames consist of a start bit of logic 0, eight (or nine) data bits (LSB first), and a stop bit of logic 1. For information about 9-bit data mode, refer to Section 13.3.5.1, “8- and 9-Bit Data Modes.” For the remainder of this discussion, we assume the SCI is configured for normal 8-bit data mode.

After receiving the stop bit into the receive shifter, and provided the receive data register is not already full, the data character is transferred to the receive data register and the receive data register full (RDRF)

status flag is set. If RDRF was already set indicating the receive data register (buffer) was already full, the overrun (OR) status flag is set and the new data is lost. Because the SCI receiver is double-buffered, the program has one full character time after RDRF is set before the data in the receive data buffer must be read to avoid a receiver overrun.

When a program detects that the receive data register is full ( $RDRF = 1$ ), it gets the data from the receive data register by reading SCID. The RDRF flag is cleared automatically by a 2-step sequence which is normally satisfied in the course of the user's program that handles receive data. Refer to [Section 13.3.4, "Interrupts and Status Flags"](#) for more details about flag clearing.

### 13.3.3.1 Data Sampling Technique

The SCI receiver uses a  $16\times$  baud rate clock for sampling. The receiver starts by taking logic level samples at 16 times the baud rate to search for a falling edge on the RxD serial data input pin. A falling edge is defined as a logic 0 sample after three consecutive logic 1 samples. The  $16\times$  baud rate clock is used to divide the bit time into 16 segments labeled RT1 through RT16. When a falling edge is located, three more samples are taken at RT3, RT5, and RT7 to make sure this was a real start bit and not merely noise. If at least two of these three samples are 0, the receiver assumes it is synchronized to a receive character.

The receiver then samples each bit time, including the start and stop bits, at RT8, RT9, and RT10 to determine the logic level for that bit. The logic level is interpreted to be that of the majority of the samples taken during the bit time. In the case of the start bit, the bit is assumed to be 0 if at least two of the samples at RT3, RT5, and RT7 are 0 even if one or all of the samples taken at RT8, RT9, and RT10 are 1s. If any sample in any bit time (including the start and stop bits) in a character frame fails to agree with the logic level for that bit, the noise flag (NF) will be set when the received character is transferred to the receive data buffer.

The falling edge detection logic continuously looks for falling edges, and if an edge is detected, the sample clock is resynchronized to bit times. This improves the reliability of the receiver in the presence of noise or mismatched baud rates. It does not improve worst case analysis because some characters do not have any extra falling edges anywhere in the character frame.

In the case of a framing error, provided the received character was not a break character, the sampling logic that searches for a falling edge is filled with three logic 1 samples so that a new start bit can be detected almost immediately.

In the case of a framing error, the receiver is inhibited from receiving any new characters until the framing error flag is cleared. The receive shift register continues to function, but a complete character cannot transfer to the receive data buffer if FE is still set.

### 13.3.3.2 Receiver Wakeup Operation

Receiver wakeup is a hardware mechanism that allows an SCI receiver to ignore the characters in a message that is intended for a different SCI receiver. In such a system, all receivers evaluate the first character(s) of each message, and as soon as they determine the message is intended for a different receiver, they write logic 1 to the receiver wake up (RWU) control bit in SCIC2. When RWU bit is set, the status flags associated with the receiver (with the exception of the idle bit, IDLE, when RWUID bit is set) are inhibited from setting, thus eliminating the software overhead for handling the unimportant message

characters. At the end of a message, or at the beginning of the next message, all receivers automatically force RWU to 0 so all receivers wake up in time to look at the first character(s) of the next message.

### 13.3.3.2.1 Idle-Line Wakeup

When WAKE = 0, the receiver is configured for idle-line wakeup. In this mode, RWU is cleared automatically when the receiver detects a full character time of the idle-line level. The M control bit selects 8-bit or 9-bit data mode that determines how many bit times of idle are needed to constitute a full character time (10 or 11 bit times because of the start and stop bits).

When RWU is one and RWUID is zero, the idle condition that wakes up the receiver does not set the IDLE flag. The receiver wakes up and waits for the first data character of the next message which will set the RDRF flag and generate an interrupt if enabled. When RWUID is one, any idle condition sets the IDLE flag and generates an interrupt if enabled, regardless of whether RWU is zero or one.

The idle-line type (ILT) control bit selects one of two ways to detect an idle line. When ILT = 0, the idle bit counter starts after the start bit so the stop bit and any logic 1s at the end of a character count toward the full character time of idle. When ILT = 1, the idle bit counter does not start until after a stop bit time, so the idle detection is not affected by the data in the last character of the previous message.

### 13.3.3.2.2 Address-Mark Wakeup

When WAKE = 1, the receiver is configured for address-mark wakeup. In this mode, RWU is cleared automatically when the receiver detects a logic 1 in the most significant bit of a received character (eighth bit in M = 0 mode and ninth bit in M = 1 mode).

Address-mark wakeup allows messages to contain idle characters but requires that the MSB be reserved for use in address frames. The logic 1 MSB of an address frame clears the RWU bit before the stop bit is received and sets the RDRF flag. In this case the character with the MSB set is received even though the receiver was sleeping during most of this character time.

## 13.3.4 Interrupts and Status Flags

The SCI system has three separate interrupt vectors to reduce the amount of software needed to isolate the cause of the interrupt. One interrupt vector is associated with the transmitter for TDRE and TC events. Another interrupt vector is associated with the receiver for RDRF, IDLE, RXEDGIF and LBKDIF events, and a third vector is used for OR, NF, FE, and PF error conditions. Each of these ten interrupt sources can be separately masked by local interrupt enable masks. The flags can still be polled by software when the local masks are cleared to disable generation of hardware interrupt requests.

The SCI transmitter has two status flags that optionally can generate hardware interrupt requests. Transmit data register empty (TDRE) indicates when there is room in the transmit data buffer to write another transmit character to SCID. If the transmit interrupt enable (TIE) bit is set, a hardware interrupt will be requested whenever TDRE = 1. Transmit complete (TC) indicates that the transmitter is finished transmitting all data, preamble, and break characters and is idle with TxD at the inactive level. This flag is often used in systems with modems to determine when it is safe to turn off the modem. If the transmit complete interrupt enable (TCIE) bit is set, a hardware interrupt will be requested whenever TC = 1.

Instead of hardware interrupts, software polling may be used to monitor the TDRE and TC status flags if the corresponding TIE or TCIE local interrupt masks are 0s.

When a program detects that the receive data register is full ( $RDRF = 1$ ), it gets the data from the receive data register by reading SCID. The RDRF flag is cleared by reading SCIS1 while  $RDRF = 1$  and then reading SCID.

When polling is used, this sequence is naturally satisfied in the normal course of the user program. If hardware interrupts are used, SCIS1 must be read in the interrupt service routine (ISR). Normally, this is done in the ISR anyway to check for receive errors, so the sequence is automatically satisfied.

The IDLE status flag includes logic that prevents it from getting set repeatedly when the RxD line remains idle for an extended period of time. IDLE is cleared by reading SCIS1 while  $IDLE = 1$  and then reading SCID. After IDLE has been cleared, it cannot become set again until the receiver has received at least one new character and has set RDRF.

If the associated error was detected in the received character that caused RDRF to be set, the error flags — noise flag (NF), framing error (FE), and parity error flag (PF) — get set at the same time as RDRF. These flags are not set in overrun cases.

If RDRF was already set when a new character is ready to be transferred from the receive shifter to the receive data buffer, the overrun (OR) flag gets set instead the data along with any associated NF, FE, or PF condition is lost.

At any time, an active edge on the RxD serial data input pin causes the RXEDGIF flag to set. The RXEDGIF flag is cleared by writing a “1” to it. This function does depend on the receiver being enabled ( $RE = 1$ ).

### 13.3.5 Additional SCI Functions

The following sections describe additional SCI functions.

#### 13.3.5.1 8- and 9-Bit Data Modes

The SCI system (transmitter and receiver) can be configured to operate in 9-bit data mode by setting the M control bit in SCIC1. In 9-bit mode, there is a ninth data bit to the left of the MSB of the SCI data register. For the transmit data buffer, this bit is stored in T8 in SCIC3. For the receiver, the ninth bit is held in R8 in SCIC3.

For coherent writes to the transmit data buffer, write to the T8 bit before writing to SCID.

If the bit value to be transmitted as the ninth bit of a new character is the same as for the previous character, it is not necessary to write to T8 again. When data is transferred from the transmit data buffer to the transmit shifter, the value in T8 is copied at the same time data is transferred from SCID to the shifter.

9-bit data mode typically is used in conjunction with parity to allow eight bits of data plus the parity in the ninth bit. Or it is used with address-mark wakeup so the ninth data bit can serve as the wakeup bit. In custom protocols, the ninth bit can also serve as a software-controlled marker.

### 13.3.5.2 Stop Mode Operation

During all stop modes, clocks to the SCI module are halted.

In stop1 and stop2 modes, all SCI register data is lost and must be re-initialized upon recovery from these two stop modes. No SCI module registers are affected in stop3 mode.

The receive input active edge detect circuit is still active in stop3 mode, but not in stop2. An active edge on the receive input brings the CPU out of stop3 mode if the interrupt is not masked (RXEDGIE = 1).

Note, because the clocks are halted, the SCI module will resume operation upon exit from stop (only in stop3 mode). Software should ensure stop mode is not entered while there is a character being transmitted out of or received into the SCI module.

### 13.3.5.3 Loop Mode

When LOOPS = 1, the RSRC bit in the same register chooses between loop mode (RSRC = 0) or single-wire mode (RSRC = 1). Loop mode is sometimes used to check software, independent of connections in the external system, to help isolate system problems. In this mode, the transmitter output is internally connected to the receiver input and the RxD pin is not used by the SCI, so it reverts to a general-purpose port I/O pin.

### 13.3.5.4 Single-Wire Operation

When LOOPS = 1, the RSRC bit in the same register chooses between loop mode (RSRC = 0) or single-wire mode (RSRC = 1). Single-wire mode is used to implement a half-duplex serial connection. The receiver is internally connected to the transmitter output and to the TxD pin. The RxD pin is not used and reverts to a general-purpose port I/O pin.

In single-wire mode, the TXDIR bit in SCIC3 controls the direction of serial data on the TxD pin. When TXDIR = 0, the TxD pin is an input to the SCI receiver and the transmitter is temporarily disconnected from the TxD pin so an external device can send serial data to the receiver. When TXDIR = 1, the TxD pin is an output driven by the transmitter. In single-wire mode, the internal loop back connection from the transmitter to the receiver causes the receiver to receive characters that are sent out by the transmitter.



## Chapter 14

# Development Support

### 14.1 Introduction

Development support systems in the S08 family include the S08 background debug controller (BDC).

The BDC provides a single-wire debug interface to the target MCU. This interface provides a convenient means for programming the on-chip flash and other nonvolatile memories. Also, the BDC is the primary debug interface for development and allows non-intrusive access to memory data and traditional debug features such as CPU register modify, breakpoint, and single-instruction trace commands.

In the S08 family, address and data bus signals are not available on external pins. Debug is done through commands fed into the target MCU via the single-wire background debug interface, including resetting the device without using a reset pin.

## 14.1.1 Features

Features of the BDC module include:

- Single pin for mode selection and background communications
- BDC registers are not located in the memory map
- SYNC command to determine target communications rate
- Non-intrusive commands for memory access
- Active background mode commands for CPU register access
- GO and TRACE1 commands
- BACKGROUND command can wake CPU from stop or wait modes
- One hardware address breakpoint built into BDC
- Oscillator runs in stop mode, if BDC enabled
- COP watchdog disabled while in active background mode

Features of the ICE system include:

- Two trigger comparators: Two address + read/write (R/W) or one full address + data + R/W
- Flexible 8-word by 16-bit FIFO (first-in, first-out) buffer for capture information:
  - Change-of-flow addresses or
  - Event-only data
- Two types of breakpoints:
  - Tag breakpoints for instruction opcodes
  - Force breakpoints for any address access
- Nine trigger modes:
  - Basic: A-only, A OR B
  - Sequence: A then B
  - Full: A AND B data, A AND NOT B data
  - Event (store data): Event-only B, A then event-only B
  - Range: Inside range ( $A \leq \text{address} \leq B$ ), outside range ( $\text{address} < A$  or  $\text{address} > B$ )

## 14.2 Background Debug Controller (BDC)

All MCUs in the HCS08 Family contain a single-wire background debug interface that supports in-circuit programming of on-chip nonvolatile memory and sophisticated non-intrusive debug capabilities. Unlike debug interfaces on earlier 8-bit MCUs, this system does not interfere with normal application resources. It does not use any user memory or locations in the memory map and does not share any on-chip peripherals.

BDC commands are divided into two groups:

- Active background mode commands require that the target MCU is in active background mode (the user program is not running). Active background mode commands allow the CPU registers to be



read or written, and allow the user to trace one user instruction at a time, or GO to the user program from active background mode.

- Non-intrusive commands can be executed at any time even while the user's program is running. Non-intrusive commands allow a user to read or write MCU memory locations or access status and control registers within the background debug controller.

Typically, a relatively simple interface pod is used to translate commands from a host computer into commands for the custom serial interface to the single-wire background debug system. Depending on the development tool vendor, this interface pod may use a standard RS-232 serial port, a parallel printer port, or some other type of communications such as a universal serial bus (USB) to communicate between the host PC and the pod. The pod typically connects to the target system with ground, the BKGD pin,  $\overline{\text{RESET}}$ , and sometimes  $V_{\text{DD}}$ . An open-drain connection to reset allows the host to force a target system reset, which is useful to regain control of a lost target system or to control startup of a target system before the on-chip nonvolatile memory has been programmed. Sometimes  $V_{\text{DD}}$  can be used to allow the pod to use power from the target system to avoid the need for a separate power supply. However, if the pod is powered separately, it can be connected to a running target system without forcing a target system reset or otherwise disturbing the running application program.

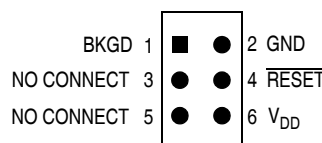

Figure 14-1. BDM Tool Connector

## 14.2.1 BKGD Pin Description

BKGD is the single-wire background debug interface pin. The primary function of this pin is for bidirectional serial communication of active background mode commands and data. During reset, this pin is used to select between starting in active background mode or starting the user's application program. This pin is also used to request a timed sync response pulse to allow a host development tool to determine the correct clock frequency for background debug serial communications.

BDC serial communications use a custom serial protocol first introduced on the M68HC12 Family of microcontrollers. This protocol assumes the host knows the communication clock rate that is determined by the target BDC clock rate. All communication is initiated and controlled by the host that drives a high-to-low edge to signal the beginning of each bit time. Commands and data are sent most significant bit first (MSB first). For a detailed description of the communications protocol, refer to [Section 14.2.2, "Communication Details."](#)

If a host is attempting to communicate with a target MCU that has an unknown BDC clock rate, a SYNC command may be sent to the target MCU to request a timed sync response signal from which the host can determine the correct communication speed.

BKGD is a pseudo-open-drain pin and there is an on-chip pullup so no external pullup resistor is required. Unlike typical open-drain pins, the external RC time constant on this pin, which is influenced by external capacitance, plays almost no role in signal rise time. The custom protocol provides for brief, actively

driven speedup pulses to force rapid rise times on this pin without risking harmful drive level conflicts. Refer to [Section 14.2.2, “Communication Details,”](#) for more detail.

When no debugger pod is connected to the 6-pin BDM interface connector, the internal pullup on BKGD chooses normal operating mode. When a debug pod is connected to BKGD it is possible to force the MCU into active background mode after reset. The specific conditions for forcing active background depend upon the HCS08 derivative (refer to the introduction to this Development Support section). It is not necessary to reset the target MCU to communicate with it through the background debug interface.

## 14.2.2 Communication Details

The BDC serial interface requires the external controller to generate a falling edge on the BKGD pin to indicate the start of each bit time. The external controller provides this falling edge whether data is transmitted or received.

BKGD is a pseudo-open-drain pin that can be driven either by an external controller or by the MCU. Data is transferred MSB first at 16 BDC clock cycles per bit (nominal speed). The interface times out if 512 BDC clock cycles occur between falling edges from the host. Any BDC command that was in progress when this timeout occurs is aborted without affecting the memory or operating mode of the target MCU system.

The custom serial protocol requires the debug pod to know the target BDC communication clock speed.

The clock switch (CLKSW) control bit in the BDC status and control register allows the user to select the BDC clock source. The BDC clock source can either be the bus or the alternate BDC clock source.

The BKGD pin can receive a high or low level or transmit a high or low level. The following diagrams show timing for each of these cases. Interface timing is synchronous to clocks in the target BDC, but asynchronous to the external host. The internal BDC clock signal is shown for reference in counting cycles.

[Figure 14-2](#) shows an external host transmitting a logic 1 or 0 to the BKGD pin of a target HCS08 MCU. The host is asynchronous to the target so there is a 0-to-1 cycle delay from the host-generated falling edge to where the target perceives the beginning of the bit time. Ten target BDC clock cycles later, the target senses the bit level on the BKGD pin. Typically, the host actively drives the pseudo-open-drain BKGD pin during host-to-target transmissions to speed up rising edges. Because the target does not drive the BKGD pin during the host-to-target transmission period, there is no need to treat the line as an open-drain signal during this period.

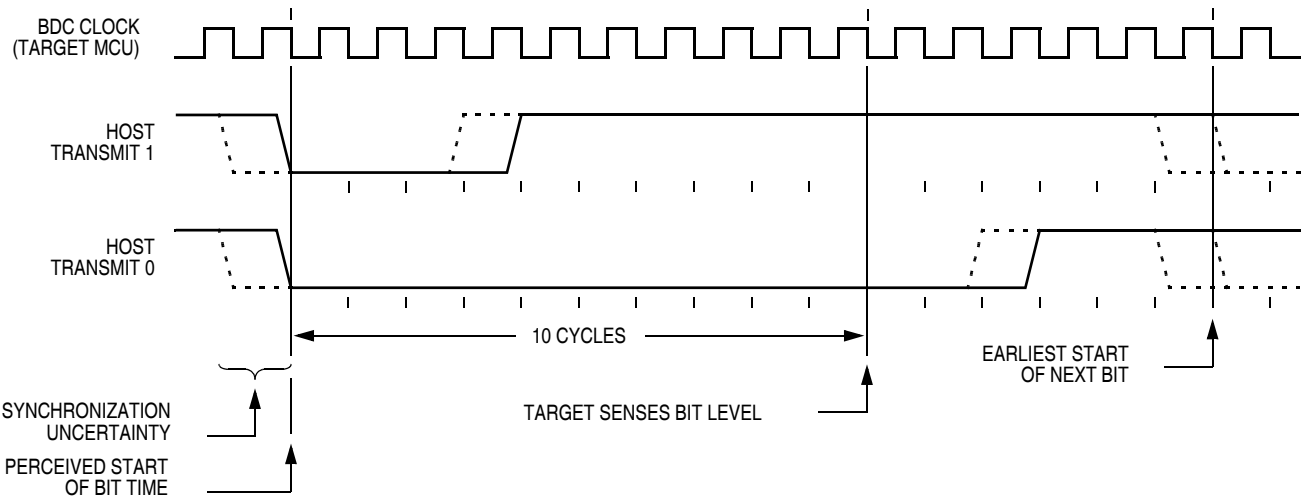

**Figure 14-2. BDC Host-to-Target Serial Bit Timing**

Figure 14-3 shows the host receiving a logic 1 from the target HCS08 MCU. Because the host is asynchronous to the target MCU, there is a 0-to-1 cycle delay from the host-generated falling edge on BKGD to the perceived start of the bit time in the target MCU. The host holds the BKGD pin low long enough for the target to recognize it (at least two target BDC cycles). The host must release the low drive before the target MCU drives a brief active-high speedup pulse seven cycles after the perceived start of the bit time. The host should sample the bit level about 10 cycles after it started the bit time.

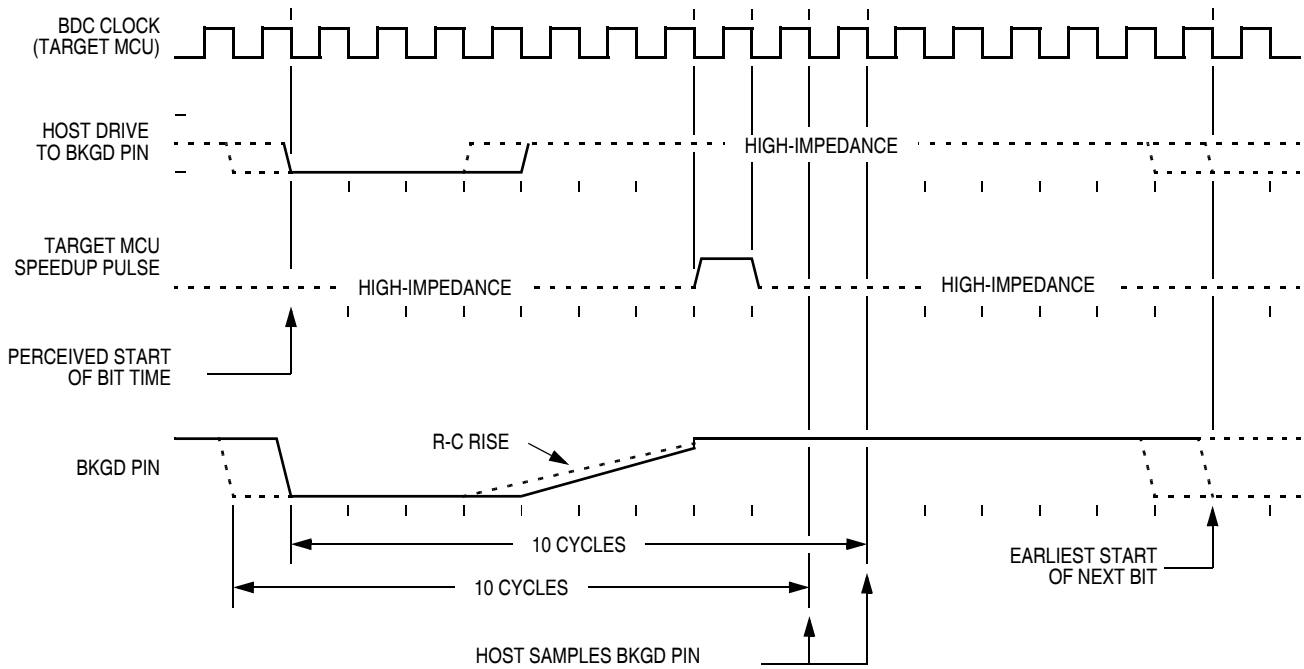

**Figure 14-3. BDC Target-to-Host Serial Bit Timing (Logic 1)**

Figure 14-4 shows the host receiving a logic 0 from the target HCS08 MCU. Because the host is asynchronous to the target MCU, there is a 0-to-1 cycle delay from the host-generated falling edge on BKGD to the start of the bit time as perceived by the target MCU. The host initiates the bit time but the target HCS08 finishes it. Because the target wants the host to receive a logic 0, it drives the BKGD pin low for 13 BDC clock cycles, then briefly drives it high to speed up the rising edge. The host samples the bit level about 10 cycles after starting the bit time.

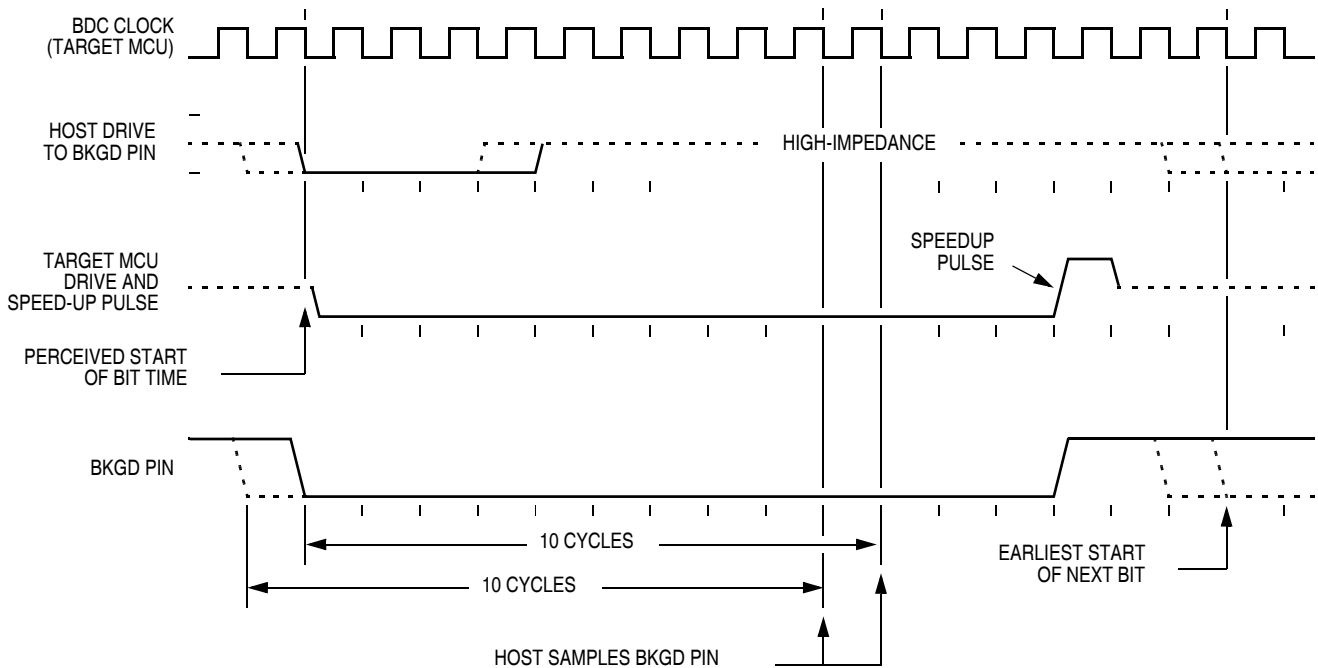

Figure 14-4. BDM Target-to-Host Serial Bit Timing (Logic 0)

### 14.2.3 BDC Commands

BDC commands are sent serially from a host computer to the BKGD pin of the target HCS08 MCU. All commands and data are sent MSB-first using a custom BDC communications protocol. Active background mode commands require that the target MCU is currently in the active background mode while non-intrusive commands may be issued at any time whether the target MCU is in active background mode or running a user application program.

Table 14-1 shows all HCS08 BDC commands, a shorthand description of their coding structure, and the meaning of each command.

#### Coding Structure Nomenclature

This nomenclature is used in Table 14-1 to describe the coding structure of the BDC commands.

Commands begin with an 8-bit hexadecimal command code in the host-to-target direction (most significant bit first)

- / = separates parts of the command
- d = delay 16 target BDC clock cycles
- AAAA = a 16-bit address in the host-to-target direction
- RD = 8 bits of read data in the target-to-host direction
- WD = 8 bits of write data in the host-to-target direction
- RD16 = 16 bits of read data in the target-to-host direction
- WD16 = 16 bits of write data in the host-to-target direction
- SS = the contents of BDCSCR in the target-to-host direction (STATUS)
- CC = 8 bits of write data for BDCSCR in the host-to-target direction (CONTROL)
- RBKP = 16 bits of read data in the target-to-host direction (from BDCBKPT breakpoint register)
- WBKP = 16 bits of write data in the host-to-target direction (for BDCBKPT breakpoint register)

**Table 14-1. BDC Command Summary**

Command Mnemonic	Active BDM/ Non-intrusive	Coding Structure	Description
SYNC	Non-intrusive	n/a <sup>1</sup>	Request a timed reference pulse to determine target BDC communication speed
ACK_ENABLE	Non-intrusive	D5/d	Enable acknowledge protocol. Refer to Freescale document order no. HCS08RMv1/D.
ACK_DISABLE	Non-intrusive	D6/d	Disable acknowledge protocol. Refer to Freescale document order no. HCS08RMv1/D.
BACKGROUND	Non-intrusive	90/d	Enter active background mode if enabled (ignore if ENBDM bit equals 0)
READ_STATUS	Non-intrusive	E4/SS	Read BDC status from BDCSCR
WRITE_CONTROL	Non-intrusive	C4/CC	Write BDC controls in BDCSCR
READ_BYTE	Non-intrusive	E0/AAAA/d/RD	Read a byte from target memory
READ_BYTE_WS	Non-intrusive	E1/AAAA/d/SS/RD	Read a byte and report status
READ_LAST	Non-intrusive	E8/SS/RD	Re-read byte from address just read and report status
WRITE_BYTE	Non-intrusive	C0/AAAA/WD/d	Write a byte to target memory
WRITE_BYTE_WS	Non-intrusive	C1/AAAA/WD/d/SS	Write a byte and report status
READ_BKPT	Non-intrusive	E2/RBKP	Read BDCBKPT breakpoint register
WRITE_BKPT	Non-intrusive	C2/WBKP	Write BDCBKPT breakpoint register
GO	Active BDM	08/d	Go to execute the user application program starting at the address currently in the PC
TRACE1	Active BDM	10/d	Trace 1 user instruction at the address in the PC, then return to active background mode
TAGGO	Active BDM	18/d	Same as GO but enable external tagging (HCS08 devices have no external tagging pin)
READ_A	Active BDM	68/d/RD	Read accumulator (A)
READ_CCR	Active BDM	69/d/RD	Read condition code register (CCR)
READ_PC	Active BDM	6B/d/RD16	Read program counter (PC)
READ_HX	Active BDM	6C/d/RD16	Read H and X register pair (H:X)
READ_SP	Active BDM	6F/d/RD16	Read stack pointer (SP)
READ_NEXT	Active BDM	70/d/RD	Increment H:X by one then read memory byte located at H:X
READ_NEXT_WS	Active BDM	71/d/SS/RD	Increment H:X by one then read memory byte located at H:X. Report status and data.
WRITE_A	Active BDM	48/WD/d	Write accumulator (A)
WRITE_CCR	Active BDM	49/WD/d	Write condition code register (CCR)
WRITE_PC	Active BDM	4B/WD16/d	Write program counter (PC)
WRITE_HX	Active BDM	4C/WD16/d	Write H and X register pair (H:X)
WRITE_SP	Active BDM	4F/WD16/d	Write stack pointer (SP)
WRITE_NEXT	Active BDM	50/WD/d	Increment H:X by one, then write memory byte located at H:X
WRITE_NEXT_WS	Active BDM	51/WD/d/SS	Increment H:X by one, then write memory byte located at H:X. Also report status.

<sup>1</sup> The SYNC command is a special operation that does not have a command code.

The SYNC command is unlike other BDC commands because the host does not necessarily know the correct communications speed to use for BDC communications until after it has analyzed the response to the SYNC command.

To issue a SYNC command, the host:

- Drives the BKGD pin low for at least 128 cycles of the slowest possible BDC clock (The slowest clock is normally the reference oscillator/64 or the self-clocked rate/64.)
- Drives BKGD high for a brief speedup pulse to get a fast rise time (This speedup pulse is typically one cycle of the fastest clock in the system.)
- Removes all drive to the BKGD pin so it reverts to high impedance
- Monitors the BKGD pin for the sync response pulse

The target, upon detecting the SYNC request from the host (which is a much longer low time than would ever occur during normal BDC communications):

- Waits for BKGD to return to a logic high
- Delays 16 cycles to allow the host to stop driving the high speedup pulse
- Drives BKGD low for 128 BDC clock cycles
- Drives a 1-cycle high speedup pulse to force a fast rise time on BKGD
- Removes all drive to the BKGD pin so it reverts to high impedance

The host measures the low time of this 128-cycle sync response pulse and determines the correct speed for subsequent BDC communications. Typically, the host can determine the correct communication speed within a few percent of the actual target speed and the communication protocol can easily tolerate speed errors of several percent.

#### 14.2.4 BDC Hardware Breakpoint

The BDC includes one relatively simple hardware breakpoint that compares the CPU address bus to a 16-bit match value in the BDCBKPT register. This breakpoint can generate a forced breakpoint or a tagged breakpoint. A forced breakpoint causes the CPU to enter active background mode at the first instruction boundary following any access to the breakpoint address. The tagged breakpoint causes the instruction opcode at the breakpoint address to be tagged so that the CPU will enter active background mode rather than executing that instruction if and when it reaches the end of the instruction queue. This implies that tagged breakpoints can only be placed at the address of an instruction opcode while forced breakpoints can be set at any address.

The breakpoint enable (BKPTEN) control bit in the BDC status and control register (BDCSCR) is used to enable the breakpoint logic (BKPTEN = 1). When BKPTEN = 0, its default value after reset, the breakpoint logic is disabled and no BDC breakpoints are requested regardless of the values in other BDC breakpoint registers and control bits. The force/tag select (FTS) control bit in BDCSCR is used to select forced (FTS = 1) or tagged (FTS = 0) type breakpoints.

The on-chip debug module (DBG) includes circuitry for two additional hardware breakpoints that are more flexible than the simple breakpoint in the BDC module.



## 14.3 On-Chip Debug System (DBG)

Because HCS08 devices do not have external address and data buses, the most important functions of an in-circuit emulator have been built onto the chip with the MCU. The debug system consists of an 8-stage FIFO that can store address or data bus information, and a flexible trigger system to decide when to capture bus information and what information to capture. The system relies on the single-wire background debug system to access debug control registers and to read results out of the eight stage FIFO.

The debug module includes control and status registers that are accessible in the user's memory map. These registers are located in the high register space to avoid using valuable direct page memory space.

Most of the debug module's functions are used during development, and user programs rarely access any of the control and status registers for the debug module. The one exception is that the debug system can provide the means to implement a form of ROM patching. This topic is discussed in greater detail in [Section 14.3.6, "Hardware Breakpoints."](#)

### 14.3.1 Comparators A and B

Two 16-bit comparators (A and B) can optionally be qualified with the R/W signal and an opcode tracking circuit. Separate control bits allow you to ignore R/W for each comparator. The opcode tracking circuitry optionally allows you to specify that a trigger will occur only if the opcode at the specified address is actually executed as opposed to only being read from memory into the instruction queue. The comparators are also capable of magnitude comparisons to support the inside range and outside range trigger modes. Comparators are disabled temporarily during all BDC accesses.

The A comparator is always associated with the 16-bit CPU address. The B comparator compares to the CPU address or the 8-bit CPU data bus, depending on the trigger mode selected. Because the CPU data bus is separated into a read data bus and a write data bus, the RWAEN and RWA control bits have an additional purpose, in full address plus data comparisons they are used to decide which of these buses to use in the comparator B data bus comparisons. If RWAEN = 1 (enabled) and RWA = 0 (write), the CPU's write data bus is used. Otherwise, the CPU's read data bus is used.

The currently selected trigger mode determines what the debugger logic does when a comparator detects a qualified match condition. A match can cause:

- Generation of a breakpoint to the CPU
- Storage of data bus values into the FIFO
- Starting to store change-of-flow addresses into the FIFO (begin type trace)
- Stopping the storage of change-of-flow addresses into the FIFO (end type trace)

### 14.3.2 Bus Capture Information and FIFO Operation

The usual way to use the FIFO is to setup the trigger mode and other control options, then arm the debugger. When the FIFO has filled or the debugger has stopped storing data into the FIFO, you would read the information out of it in the order it was stored into the FIFO. Status bits indicate the number of words of valid information that are in the FIFO as data is stored into it. If a trace run is manually halted by writing 0 to ARM before the FIFO is full (CNT = 1:0:0:0), the information is shifted by one position and

the host must perform  $((8 - \text{CNT}) - 1)$  dummy reads of the FIFO to advance it to the first significant entry in the FIFO.

In most trigger modes, the information stored in the FIFO consists of 16-bit change-of-flow addresses. In these cases, read DBGFH then DBGFL to get one coherent word of information out of the FIFO. Reading DBGFL (the low-order byte of the FIFO data port) causes the FIFO to shift so the next word of information is available at the FIFO data port. In the event-only trigger modes (see [Section 14.3.5, “Trigger Modes”](#)), 8-bit data information is stored into the FIFO. In these cases, the high-order half of the FIFO (DBGFH) is not used and data is read out of the FIFO by simply reading DBGFL. Each time DBGFL is read, the FIFO is shifted so the next data value is available through the FIFO data port at DBGFL.

In trigger modes where the FIFO is storing change-of-flow addresses, there is a delay between CPU addresses and the input side of the FIFO. Because of this delay, if the trigger event itself is a change-of-flow address or a change-of-flow address appears during the next two bus cycles after a trigger event starts the FIFO, it will not be saved into the FIFO. In the case of an end-trace, if the trigger event is a change-of-flow, it will be saved as the last change-of-flow entry for that debug run.

The FIFO can also be used to generate a profile of executed instruction addresses when the debugger is not armed. When  $\text{ARM} = 0$ , reading DBGFL causes the address of the most-recently fetched opcode to be saved in the FIFO. To use the profiling feature, a host debugger would read addresses out of the FIFO by reading DBGFH then DBGFL at regular periodic intervals. The first eight values would be discarded because they correspond to the eight DBGFL reads needed to initially fill the FIFO. Additional periodic reads of DBGFH and DBGFL return delayed information about executed instructions so the host debugger can develop a profile of executed instruction addresses.

### 14.3.3 Change-of-Flow Information

To minimize the amount of information stored in the FIFO, only information related to instructions that cause a change to the normal sequential execution of instructions is stored. With knowledge of the source and object code program stored in the target system, an external debugger system can reconstruct the path of execution through many instructions from the change-of-flow information stored in the FIFO.

For conditional branch instructions where the branch is taken (branch condition was true), the source address is stored (the address of the conditional branch opcode). Because BRA and BRN instructions are not conditional, these events do not cause change-of-flow information to be stored in the FIFO.

Indirect JMP and JSR instructions use the current contents of the H:X index register pair to determine the destination address, so the debug system stores the run-time destination address for any indirect JMP or JSR. For interrupts, RTI, or RTS, the destination address is stored in the FIFO as change-of-flow information.

### 14.3.4 Tag vs. Force Breakpoints and Triggers

Tagging is a term that refers to identifying an instruction opcode as it is fetched into the instruction queue, but not taking any other action until and unless that instruction is actually executed by the CPU. This distinction is important because any change-of-flow from a jump, branch, subroutine call, or interrupt causes some instructions that have been fetched into the instruction queue to be thrown away without being executed.

A force-type breakpoint waits for the current instruction to finish and then acts upon the breakpoint request. The usual action in response to a breakpoint is to go to active background mode rather than continuing to the next instruction in the user application program.

The tag vs. force terminology is used in two contexts within the debug module. The first context refers to breakpoint requests from the debug module to the CPU. The second refers to match signals from the comparators to the debugger control logic. When a tag-type break request is sent to the CPU, a signal is entered into the instruction queue along with the opcode so that if/when this opcode ever executes, the CPU will effectively replace the tagged opcode with a BGND opcode so the CPU goes to active background mode rather than executing the tagged instruction. When the TRGSEL control bit in the DBGTC register is set to select tag-type operation, the output from comparator A or B is qualified by a block of logic in the debug module that tracks opcodes and only produces a trigger to the debugger if the opcode at the compare address is actually executed. There is separate opcode tracking logic for each comparator so more than one compare event can be tracked through the instruction queue at a time.

### 14.3.5 Trigger Modes

The trigger mode controls the overall behavior of a debug run. The 4-bit TRG field in the DBGTC register selects one of nine trigger modes. When TRGSEL = 1 in the DBGTC register, the output of the comparator must propagate through an opcode tracking circuit before triggering FIFO actions. The BEGIN bit in DBGTC chooses whether the FIFO begins storing data when the qualified trigger is detected (begin trace), or the FIFO stores data in a circular fashion from the time it is armed until the qualified trigger is detected (end trigger).

A debug run is started by writing a 1 to the ARM bit in the DBGTC register, which sets the ARMF flag and clears the AF and BF flags and the CNT bits in DBGSR. A begin-trace debug run ends when the FIFO gets full. An end-trace run ends when the selected trigger event occurs. Any debug run can be stopped manually by writing a 0 to ARM or DBGGEN in DBGTC.

In all trigger modes except event-only modes, the FIFO stores change-of-flow addresses. In event-only trigger modes, the FIFO stores data in the low-order eight bits of the FIFO.

The BEGIN control bit is ignored in event-only trigger modes and all such debug runs are begin type traces. When TRGSEL = 1 to select opcode fetch triggers, it is not necessary to use R/W in comparisons because opcode tags would only apply to opcode fetches that are always read cycles. It would also be unusual to specify TRGSEL = 1 while using a full mode trigger because the opcode value is normally known at a particular address.

The following trigger mode descriptions only state the primary comparator conditions that lead to a trigger. Either comparator can usually be further qualified with R/W by setting RWAEN (RWBEN) and the corresponding RWA (RWB) value to be matched against R/W. The signal from the comparator with optional R/W qualification is used to request a CPU breakpoint if BRKEN = 1 and TAG determines whether the CPU request will be a tag request or a force request.

**A-Only** — Trigger when the address matches the value in comparator A

**A OR B** — Trigger when the address matches either the value in comparator A or the value in comparator B

**A Then B** — Trigger when the address matches the value in comparator B but only after the address for another cycle matched the value in comparator A. There can be any number of cycles after the A match and before the B match.

**A AND B Data (Full Mode)** — This is called a full mode because address, data, and R/W (optionally) must match within the same bus cycle to cause a trigger event. Comparator A checks address, the low byte of comparator B checks data, and R/W is checked against RWA if RWAEN = 1. The high-order half of comparator B is not used.

In full trigger modes it is not useful to specify a tag-type CPU breakpoint (BRKEN = TAG = 1), but if you do, the comparator B data match is ignored for the purpose of issuing the tag request to the CPU and the CPU breakpoint is issued when the comparator A address matches.

**A AND NOT B Data (Full Mode)** — Address must match comparator A, data must not match the low half of comparator B, and R/W must match RWA if RWAEN = 1. All three conditions must be met within the same bus cycle to cause a trigger.

In full trigger modes it is not useful to specify a tag-type CPU breakpoint (BRKEN = TAG = 1), but if you do, the comparator B data match is ignored for the purpose of issuing the tag request to the CPU and the CPU breakpoint is issued when the comparator A address matches.

**Event-Only B (Store Data)** — Trigger events occur each time the address matches the value in comparator B. Trigger events cause the data to be captured into the FIFO. The debug run ends when the FIFO becomes full.

**A Then Event-Only B (Store Data)** — After the address has matched the value in comparator A, a trigger event occurs each time the address matches the value in comparator B. Trigger events cause the data to be captured into the FIFO. The debug run ends when the FIFO becomes full.

**Inside Range ( $A \leq \text{Address} \leq B$ )** — A trigger occurs when the address is greater than or equal to the value in comparator A and less than or equal to the value in comparator B at the same time.

**Outside Range ( $\text{Address} < A$  or  $\text{Address} > B$ )** — A trigger occurs when the address is either less than the value in comparator A or greater than the value in comparator B.

### 14.3.6 Hardware Breakpoints

The BRKEN control bit in the DBGCR register may be set to 1 to allow any of the trigger conditions described in [Section 14.3.5, “Trigger Modes,”](#) to be used to generate a hardware breakpoint request to the CPU. TAG in DBGCR controls whether the breakpoint request will be treated as a tag-type breakpoint or a force-type breakpoint. A tag breakpoint causes the current opcode to be marked as it enters the instruction queue. If a tagged opcode reaches the end of the pipe, the CPU executes a BGND instruction to go to active background mode rather than executing the tagged opcode. A force-type breakpoint causes the CPU to finish the current instruction and then go to active background mode.

If the background mode has not been enabled (ENBDM = 1) by a serial WRITE\_CONTROL command through the BKGD pin, the CPU will execute an SWI instruction instead of going to active background mode.

## 14.4 Register Definition

This section contains the descriptions of the BDC and DBG registers and control bits.

Refer to the high-page register summary in the device overview chapter of this data sheet for the absolute address assignments for all DBG registers. This section refers to registers and control bits only by their names. A Freescale-provided equate or header file is used to translate these names into the appropriate absolute addresses.

### 14.4.1 BDC Registers and Control Bits

The BDC has two registers:

- The BDC status and control register (BDCSCR) is an 8-bit register containing control and status bits for the background debug controller.
- The BDC breakpoint match register (BDCBKPT) holds a 16-bit breakpoint match address.

These registers are accessed with dedicated serial BDC commands and are not located in the memory space of the target MCU (so they do not have addresses and cannot be accessed by user programs).

Some of the bits in the BDCSCR have write limitations; otherwise, these registers may be read or written at any time. For example, the ENBDM control bit may not be written while the MCU is in active background mode. (This prevents the ambiguous condition of the control bit forbidding active background mode while the MCU is already in active background mode.) Also, the four status bits (BDMACT, WS, WSF, and DVF) are read-only status indicators and can never be written by the WRITE\_CONTROL serial BDC command. The clock switch (CLKSW) control bit may be read or written at any time.

### 14.4.1.1 BDC Status and Control Register (BDCSCR)

This register can be read or written by serial BDC commands (READ\_STATUS and WRITE\_CONTROL) but is not accessible to user programs because it is not located in the normal memory map of the MCU.

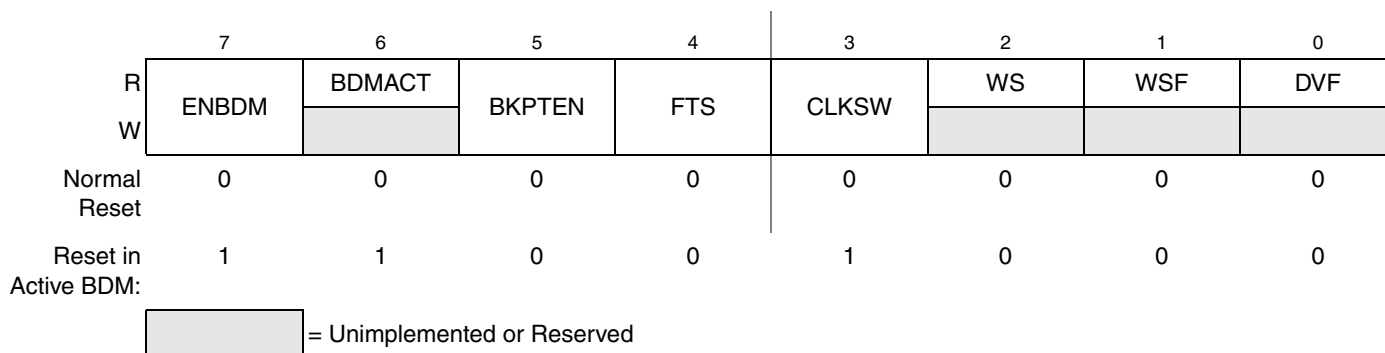

**Figure 14-5. BDC Status and Control Register (BDCSCR)**

**Table 14-2. BDCSCR Register Field Descriptions**

Field	Description
7 ENBDM	<b>Enable BDM (Permit Active Background Mode)</b> — Typically, this bit is written to 1 by the debug host shortly after the beginning of a debug session or whenever the debug host resets the target and remains 1 until a normal reset clears it. 0 BDM cannot be made active (non-intrusive commands still allowed) 1 BDM can be made active to allow active background mode commands
6 BDMACT	<b>Background Mode Active Status</b> — This is a read-only status bit. 0 BDM not active (user application program running) 1 BDM active and waiting for serial commands
5 BKPTEN	<b>BDC Breakpoint Enable</b> — If this bit is clear, the BDC breakpoint is disabled and the FTS (force tag select) control bit and BDCBKPT match register are ignored. 0 BDC breakpoint disabled 1 BDC breakpoint enabled
4 FTS	<b>Force/Tag Select</b> — When FTS = 1, a breakpoint is requested whenever the CPU address bus matches the BDCBKPT match register. When FTS = 0, a match between the CPU address bus and the BDCBKPT register causes the fetched opcode to be tagged. If this tagged opcode ever reaches the end of the instruction queue, the CPU enters active background mode rather than executing the tagged opcode. 0 Tag opcode at breakpoint address and enter active background mode if CPU attempts to execute that instruction 1 Breakpoint match forces active background mode at next instruction boundary (address need not be an opcode)
3 CLKSW	<b>Select Source for BDC Communications Clock</b> — CLKSW defaults to 0, which selects the alternate BDC clock source. 0 Alternate BDC clock source 1 MCU bus clock

**Table 14-2. BDCSCR Register Field Descriptions (continued)**

Field	Description
2 WS	<p><b>Wait or Stop Status</b> — When the target CPU is in wait or stop mode, most BDC commands cannot function. However, the BACKGROUND command can be used to force the target CPU out of wait or stop and into active background mode where all BDC commands work. Whenever the host forces the target MCU into active background mode, the host should issue a READ_STATUS command to check that BDMACT = 1 before attempting other BDC commands.</p> <p>0 Target CPU is running user application code or in active background mode (was not in wait or stop mode when background became active)</p> <p>1 Target CPU is in wait or stop mode, or a BACKGROUND command was used to change from wait or stop to active background mode</p>
1 WSF	<p><b>Wait or Stop Failure Status</b> — This status bit is set if a memory access command failed due to the target CPU executing a wait or stop instruction at or about the same time. The usual recovery strategy is to issue a BACKGROUND command to get out of wait or stop mode into active background mode, repeat the command that failed, then return to the user program. (Typically, the host would restore CPU registers and stack values and re-execute the wait or stop instruction.)</p> <p>0 Memory access did not conflict with a wait or stop instruction</p> <p>1 Memory access command failed because the CPU entered wait or stop mode</p>
0 DVF	<p><b>Data Valid Failure Status</b> — This status bit is not used in the MC9S08FL16 series because it does not have any slow access memory.</p> <p>0 Memory access did not conflict with a slow memory access</p> <p>1 Memory access command failed because CPU was not finished with a slow memory access</p>

#### 14.4.1.2 BDC Breakpoint Match Register (BDCBKPT)

This 16-bit register holds the address for the hardware breakpoint in the BDC. The BKPTEN and FTS control bits in BDCSCR are used to enable and configure the breakpoint logic. Dedicated serial BDC commands (READ\_BKPT and WRITE\_BKPT) are used to read and write the BDCBKPT register but is not accessible to user programs because it is not located in the normal memory map of the MCU. Breakpoints are normally set while the target MCU is in active background mode before running the user application program. For additional information about setup and use of the hardware breakpoint logic in the BDC, refer to [Section 14.2.4, “BDC Hardware Breakpoint.”](#)

#### 14.4.2 System Background Debug Force Reset Register (SBDFR)

This register contains a single write-only control bit. A serial background mode command such as WRITE\_BYTE must be used to write to SBDFR. Attempts to write this register from a user program are ignored. Reads always return 0x00.



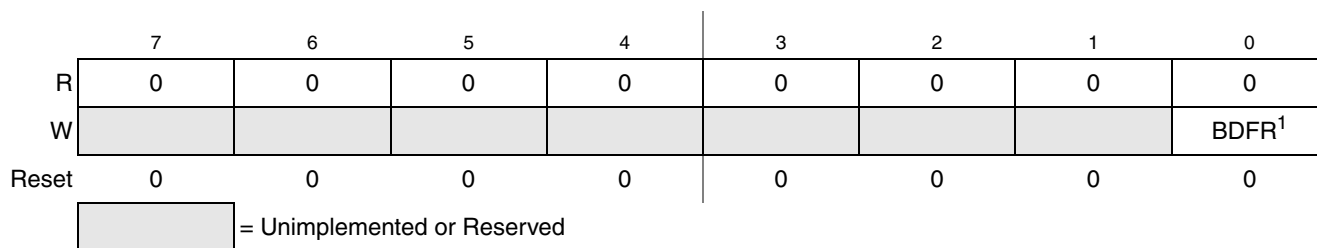

<sup>1</sup> BDFR is writable only through serial background mode debug commands, not from user programs.

**Figure 14-6. System Background Debug Force Reset Register (SBDFR)**

**Table 14-3. SBDFR Register Field Description**

Field	Description
0 BDFR	<b>Background Debug Force Reset</b> — A serial active background mode command such as WRITE_BYTE allows an external debug host to force a target system reset. Writing 1 to this bit forces an MCU reset. This bit cannot be written from a user program.

### 14.4.3 DBG Registers and Control Bits

The debug module includes nine bytes of register space for three 16-bit registers and three 8-bit control and status registers. These registers are located in the high register space of the normal memory map so they are accessible to normal application programs. These registers are rarely if ever accessed by normal user application programs with the possible exception of a ROM patching mechanism that uses the breakpoint logic.

#### 14.4.3.1 Debug Comparator A High Register (DBGCAH)

This register contains compare value bits for the high-order eight bits of comparator A. This register is forced to 0x00 at reset and can be read at any time or written at any time unless ARM = 1.

#### 14.4.3.2 Debug Comparator A Low Register (DBGCAL)

This register contains compare value bits for the low-order eight bits of comparator A. This register is forced to 0x00 at reset and can be read at any time or written at any time unless ARM = 1.

#### 14.4.3.3 Debug Comparator B High Register (DBGCBH)

This register contains compare value bits for the high-order eight bits of comparator B. This register is forced to 0x00 at reset and can be read at any time or written at any time unless ARM = 1.

#### 14.4.3.4 Debug Comparator B Low Register (DBGCBL)

This register contains compare value bits for the low-order eight bits of comparator B. This register is forced to 0x00 at reset and can be read at any time or written at any time unless ARM = 1.



### 14.4.3.5 Debug FIFO High Register (DBGFH)

This register provides read-only access to the high-order eight bits of the FIFO. Writes to this register have no meaning or effect. In the event-only trigger modes, the FIFO only stores data into the low-order byte of each FIFO word, so this register is not used and will read 0x00.

Reading DBGFH does not cause the FIFO to shift to the next word. When reading 16-bit words out of the FIFO, read DBGFH before reading DBGFL because reading DBGFL causes the FIFO to advance to the next word of information.

### 14.4.3.6 Debug FIFO Low Register (DBGFL)

This register provides read-only access to the low-order eight bits of the FIFO. Writes to this register have no meaning or effect.

Reading DBGFL causes the FIFO to shift to the next available word of information. When the debug module is operating in event-only modes, only 8-bit data is stored into the FIFO (high-order half of each FIFO word is unused). When reading 8-bit words out of the FIFO, simply read DBGFL repeatedly to get successive bytes of data from the FIFO. It isn't necessary to read DBGFH in this case.

Do not attempt to read data from the FIFO while it is still armed (after arming but before the FIFO is filled or ARMF is cleared) because the FIFO is prevented from advancing during reads of DBGFL. This can interfere with normal sequencing of reads from the FIFO.

Reading DBGFL while the debugger is not armed causes the address of the most-recently fetched opcode to be stored to the last location in the FIFO. By reading DBGFH then DBGFL periodically, external host software can develop a profile of program execution. After eight reads from the FIFO, the ninth read will return the information that was stored as a result of the first read. To use the profiling feature, read the FIFO eight times without using the data to prime the sequence and then begin using the data to get a delayed picture of what addresses were being executed. The information stored into the FIFO on reads of DBGFL (while the FIFO is not armed) is the address of the most-recently fetched opcode.

### 14.4.3.7 Debug Control Register (DBGC)

This register can be read or written at any time.

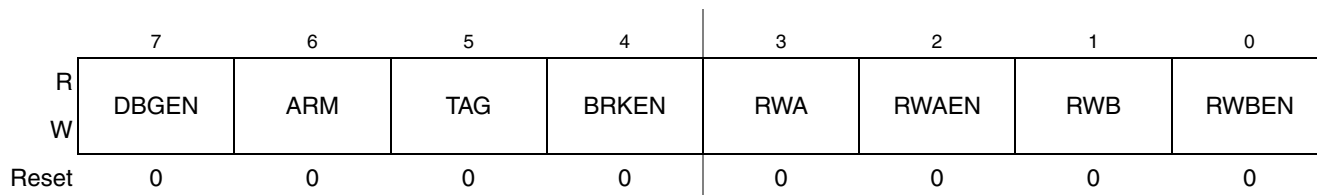

**Figure 14-7. Debug Control Register (DBGC)**

**Table 14-4. DBGC Register Field Descriptions**

Field	Description
7 DBGEN	<b>Debug Module Enable</b> — Used to enable the debug module. DBGEN cannot be set to 1 if the MCU is secure. 0 DBG disabled 1 DBG enabled
6 ARM	<b>Arm Control</b> — Controls whether the debugger is comparing and storing information in the FIFO. A write is used to set this bit (and ARMF) and completion of a debug run automatically clears it. Any debug run can be manually stopped by writing 0 to ARM or to DBGEN. 0 Debugger not armed 1 Debugger armed
5 TAG	<b>Tag/Force Select</b> — Controls whether break requests to the CPU will be tag or force type requests. If BRKEN = 0, this bit has no meaning or effect. 0 CPU breaks requested as force type requests 1 CPU breaks requested as tag type requests
4 BRKEN	<b>Break Enable</b> — Controls whether a trigger event will generate a break request to the CPU. Trigger events can cause information to be stored in the FIFO without generating a break request to the CPU. For an end trace, CPU break requests are issued to the CPU when the comparator(s) and R/W meet the trigger requirements. For a begin trace, CPU break requests are issued when the FIFO becomes full. TRGSEL does not affect the timing of CPU break requests. 0 CPU break requests not enabled 1 Triggers cause a break request to the CPU
3 RWA	<b>R/W Comparison Value for Comparator A</b> — When RWAEN = 1, this bit determines whether a read or a write access qualifies comparator A. When RWAEN = 0, RWA and the R/W signal do not affect comparator A. 0 Comparator A can only match on a write cycle 1 Comparator A can only match on a read cycle
2 RWAEN	<b>Enable R/W for Comparator A</b> — Controls whether the level of R/W is considered for a comparator A match. 0 R/W is not used in comparison A 1 R/W is used in comparison A
1 RWB	<b>R/W Comparison Value for Comparator B</b> — When RWBEN = 1, this bit determines whether a read or a write access qualifies comparator B. When RWBEN = 0, RWB and the R/W signal do not affect comparator B. 0 Comparator B can match only on a write cycle 1 Comparator B can match only on a read cycle
0 RWBEN	<b>Enable R/W for Comparator B</b> — Controls whether the level of R/W is considered for a comparator B match. 0 R/W is not used in comparison B 1 R/W is used in comparison B

### 14.4.3.8 Debug Trigger Register (DBGT)

This register can be read any time, but may be written only if ARM = 0, except bits 4 and 5 are hard-wired to 0s.

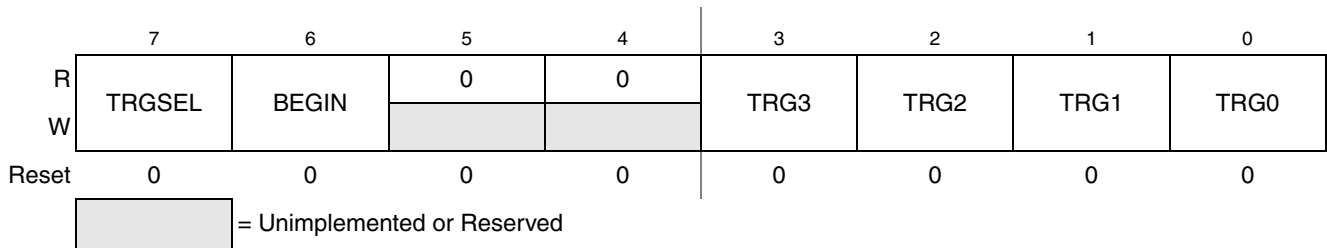

**Figure 14-8. Debug Trigger Register (DBGT)**

**Table 14-5. DBGT Register Field Descriptions**

Field	Description
7 TRGSEL	<p><b>Trigger Type</b> — Controls whether the match outputs from comparators A and B are qualified with the opcode tracking logic in the debug module. If TRGSEL is set, a match signal from comparator A or B must propagate through the opcode tracking logic and a trigger event is only signalled to the FIFO logic if the opcode at the match address is actually executed.</p> <p>0 Trigger on access to compare address (force) 1 Trigger if opcode at compare address is executed (tag)</p>
6 BEGIN	<p><b>Begin/End Trigger Select</b> — Controls whether the FIFO starts filling at a trigger or fills in a circular manner until a trigger ends the capture of information. In event-only trigger modes, this bit is ignored and all debug runs are assumed to be begin traces.</p> <p>0 Data stored in FIFO until trigger (end trace) 1 Trigger initiates data storage (begin trace)</p>
3:0 TRG[3:0]	<p><b>Select Trigger Mode</b> — Selects one of nine triggering modes, as described below.</p> <p>0000 A-only 0001 A OR B 0010 A Then B 0011 Event-only B (store data) 0100 A then event-only B (store data) 0101 A AND B data (full mode) 0110 A AND NOT B data (full mode) 0111 Inside range: <math>A \leq \text{address} \leq B</math> 1000 Outside range: <math>\text{address} &lt; A</math> or <math>\text{address} &gt; B</math> 1001 – 1111 (No trigger)</p>

### 14.4.3.9 Debug Status Register (DBGS)

This is a read-only status register.

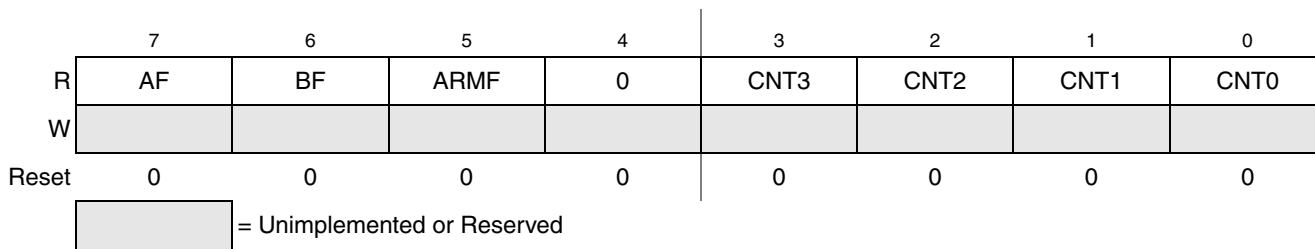

**Figure 14-9. Debug Status Register (DBGS)**

**Table 14-6. DBGS Register Field Descriptions**

Field	Description
7 AF	<p><b>Trigger Match A Flag</b> — AF is cleared at the start of a debug run and indicates whether a trigger match A condition was met since arming.</p> <p>0 Comparator A has not matched 1 Comparator A match</p>
6 BF	<p><b>Trigger Match B Flag</b> — BF is cleared at the start of a debug run and indicates whether a trigger match B condition was met since arming.</p> <p>0 Comparator B has not matched 1 Comparator B match</p>
5 ARMF	<p><b>Arm Flag</b> — While DBGEN = 1, this status bit is a read-only image of ARM in DBG. This bit is set by writing 1 to the ARM control bit in DBG (while DBGEN = 1) and is automatically cleared at the end of a debug run. A debug run is completed when the FIFO is full (begin trace) or when a trigger event is detected (end trace). A debug run can also be ended manually by writing 0 to ARM or DBGEN in DBG.</p> <p>0 Debugger not armed 1 Debugger armed</p>
3:0 CNT[3:0]	<p><b>FIFO Valid Count</b> — These bits are cleared at the start of a debug run and indicate the number of words of valid data in the FIFO at the end of a debug run. The value in CNT does not decrement as data is read out of the FIFO. The external debug host is responsible for keeping track of the count as information is read out of the FIFO.</p> <p>0000 Number of valid words in FIFO = No valid data 0001 Number of valid words in FIFO = 1 0010 Number of valid words in FIFO = 2 0011 Number of valid words in FIFO = 3 0100 Number of valid words in FIFO = 4 0101 Number of valid words in FIFO = 5 0110 Number of valid words in FIFO = 6 0111 Number of valid words in FIFO = 7 1000 Number of valid words in FIFO = 8</p>





## **How to Reach Us:**

### **Home Page:**

[www.freescale.com](http://www.freescale.com)

### **Web Support:**

<http://www.freescale.com/support>

### **USA/Europe or Locations Not Listed:**

Freescale Semiconductor, Inc.  
Technical Information Center, EL516  
2100 East Elliot Road  
Tempe, Arizona 85284  
1-800-521-6274 or +1-480-768-2130  
[www.freescale.com/support](http://www.freescale.com/support)

### **Europe, Middle East, and Africa:**

Freescale Halbleiter Deutschland GmbH  
Technical Information Center  
Schatzbogen 7  
81829 Muenchen, Germany  
+44 1296 380 456 (English)  
+46 8 52200080 (English)  
+49 89 92103 559 (German)  
+33 1 69 35 48 48 (French)  
[www.freescale.com/support](http://www.freescale.com/support)

### **Japan:**

Freescale Semiconductor Japan Ltd.  
Headquarters  
ARCO Tower 15F  
1-8-1, Shimo-Meguro, Meguro-ku,  
Tokyo 153-0064  
Japan  
0120 191014 or +81 3 5437 9125  
[support.japan@freescale.com](mailto:support.japan@freescale.com)

### **Asia/Pacific:**

Freescale Semiconductor China Ltd.  
Exchange Building 23F  
No. 118 Jianguo Road  
Chaoyang District  
Beijing 100022  
China  
+86 10 5879 8000  
[support.asia@freescale.com](mailto:support.asia@freescale.com)

### **For Literature Requests Only:**

Freescale Semiconductor Literature Distribution Center  
P.O. Box 5405  
Denver, Colorado 80217  
1-800-441-2447 or +1-303-675-2140  
Fax: +1-303-675-2150  
[LDCForFreescaleSemiconductor@hibbertgroup.com](mailto:LDCForFreescaleSemiconductor@hibbertgroup.com)

Information in this document is provided solely to enable system and software implementers to use Freescale Semiconductor products. There are no express or implied copyright licenses granted hereunder to design or fabricate any integrated circuits or integrated circuits based on the information in this document.

Freescale Semiconductor reserves the right to make changes without further notice to any products herein. Freescale Semiconductor makes no warranty, representation or guarantee regarding the suitability of its products for any particular purpose, nor does Freescale Semiconductor assume any liability arising out of the application or use of any product or circuit, and specifically disclaims any and all liability, including without limitation consequential or incidental damages. "Typical" parameters that may be provided in Freescale Semiconductor data sheets and/or specifications can and do vary in different applications and actual performance may vary over time. All operating parameters, including "Typicals", must be validated for each customer application by customer's technical experts. Freescale Semiconductor does not convey any license under its patent rights nor the rights of others. Freescale Semiconductor products are not designed, intended, or authorized for use as components in systems intended for surgical implant into the body, or other applications intended to support or sustain life, or for any other application in which the failure of the Freescale Semiconductor product could create a situation where personal injury or death may occur. Should Buyer purchase or use Freescale Semiconductor products for any such unintended or unauthorized application, Buyer shall indemnify and hold Freescale Semiconductor and its officers, employees, subsidiaries, affiliates, and distributors harmless against all claims, costs, damages, and expenses, and reasonable attorney fees arising out of, directly or indirectly, any claim of personal injury or death associated with such unintended or unauthorized use, even if such claim alleges that Freescale Semiconductor was negligent regarding the design or manufacture of the part.



Freescale™ and the Freescale logo are trademarks of Freescale Semiconductor, Inc. All other product or service names are the property of their respective owners.

© Freescale Semiconductor, Inc. 2008-2010. All rights reserved.